



General Surgery
Generelle Operation

Dear Customer,

Tritone Inc (Parent company Stone Instruments Co.) is a family owned & operated medical company, providing personalized service featuring the finest in surgical instrumentation since 1996. Our surgical instruments encompass the entire human anatomy including specialty products to precision instruments and devices.

Owner of Stone Instruments Co, Athar Jamil and his sons, Nabeel Athar, Hamza Athar and Raheel Athar bring with them a lifetime of experience creating the highest quality products made at our state-of-the-art in-house manufacturing facilities featuring, cutting edge robotic technology, handmade workmanship combined with an understanding how to make exactly what our valued customers have come to expect.

We thank you for the opportunity to present our portfolio!

Sincerely,

A handwritten signature in black ink, appearing to read 'Athar Jamil', with a long horizontal stroke extending to the left.

Athar Jamil

Scalpel handles



Fig. 7K	Fig. 7
01-1002	01-1003



Fig. 3 R	Fig. 3 RG
01-1004	01-1005



Fig. 3	Fig. 3	Fig. 3 L
01-1006	01-1007	01-1008

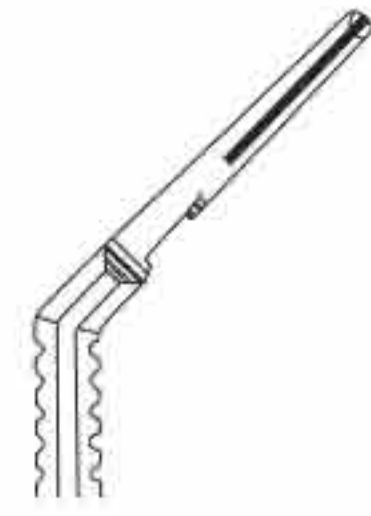

Fig. 3 L
01-1001

angled on flat



1:1

Scalpel handles



cOllin 1:1

Fig. 8 L
01-1009

hollow



Stan Dar D 1:1

Fig. 4	Fig. 4	Fig. 4 L
01-1010	01-1011	01-1012

graduated



Fig. 4 L
01-1013

angled on flat



1:1

Supercut scissors (SC)



Fig. 3 L
01-1020

An extremely sharp osteotome cut on the upper blade guarantees easy and precise cutting of the tissue. The other blade is slightly serrated for fixing the tissue. Supercut scissors are indicated by two black rings. Any other scissors can be supplied as Supercut upon request. Supercut scissors can be supplied upon request without serration.



Fig. 3 L
01-1021

All scissors with almedur[®] tungsten carbide inserts are distinguished by a uniform, smooth, and longlasting cut. Scissors having tungsten carbide inserts are identified by gold plated rings.

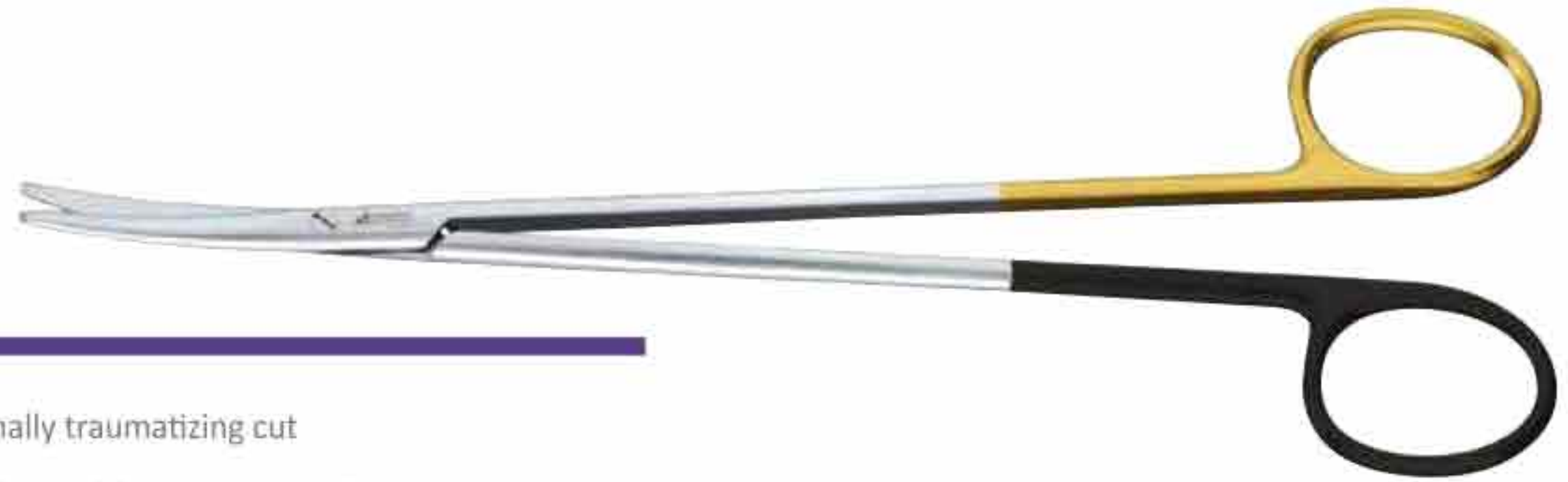

Fig. 3 L
01-1022

Knife edges and micro serration:	Fine, minimally traumatizing cut
Welded tungsten carbide cutting edges:	Corrosion-free welding seam; seamless, homogenous junction of tungsten carbide and scissors steel
Characteristics:	one golden ring, one black ring
Reduction of the transversal cut:	Better visibility + precise preparation



Fig. 3 L
01-1023

Knife edges and micro serration:	Fine, minimally traumatizing cut
Ceramic coating:	High surface hardness; long lasting cutting ability; non-dazzling surface; excellent sliding capacity
Welded tungsten carbide cutting edges:	Corrosion-free welding seam; seamless, homogenous junction of tungsten carbide and scissors steel
Characteristics:	Black finish, golden screw
Reduction of the transversal cut:	Better visibility + precise preparation

Operating scissors



		T.C		Supercut	T.C		T.C
	Fig. 1	Fig. 1	Fig. 2	Fig. 2	Fig. 2	Fig. 3	Fig. 3
105 mm – 4 ¼ "	01-1024-01	01-1025-01	01-1026-01	01-1027-01	01-1028-01	01-1029-01	01-1030-01
115 mm – 4 ½ "	01-1024-02	01-1025-02	01-1026-02	01-1027-02	01-1028-02	01-1029-02	01-1030-02
130 mm – 5 "	01-1024-03	01-1025-03	01-1026-03	01-1027-03	01-1028-03	01-1029-03	01-1030-03
145 mm – 5 ¾ "	01-1024-04	01-1025-04	01-1026-04	01-1027-04	01-1028-04	01-1029-04	01-1030-04
155 mm – 6 "	01-1024-05	01-1025-05	01-1026-05	01-1027-05	01-1028-05	01-1029-05	01-1030-05
165 mm – 6 ½ "	01-1024-06	01-1025-06	01-1026-06	01-1027-06	01-1028-06	01-1029-06	01-1030-06
175 mm – 7 "	01-1024-07	01-1025-07	01-1026-07	01-1027-07	01-1028-07	01-1029-07	01-1030-07
185 mm – 7 ¼ "	01-1024-08	01-1025-08	01-1026-08	01-1027-08	01-1028-08	01-1029-08	01-1030-08
200 mm – 8 "	01-1024-09	01-1025-09	01-1026-09	01-1027-09	01-1028-09	01-1029-09	01-1030-09



		T.C		Supercut	T.C		T.C
	Fig. 1	Fig. 1	Fig. 2	Fig. 2	Fig. 2	Fig. 3	Fig. 3
105 mm – 4 ¼ "	01-1031-01	01-1032-01	01-1033-01		01-1035-01	01-1036-01	01-1037-01
115 mm – 4 ½ "	01-1031-02	01-1032-02	01-1033-02		01-1035-02	01-1036-02	01-1037-02
130 mm – 5 "	01-1031-03	01-1032-03	01-1033-03	01-1034-01	01-1035-03	01-1036-03	01-1037-03
145 mm – 5 ¾ "	01-1031-04	01-1032-04	01-1033-04	01-1034-02	01-1035-04	01-1036-04	01-1037-04
155 mm – 6 "	01-1031-05	01-1032-05	01-1033-05		01-1035-05	01-1036-05	01-1037-05
165 mm – 6 ½ "	01-1031-06	01-1032-06	01-1033-06		01-1035-06	01-1036-06	01-1037-06
175 mm – 7 "	01-1031-07	01-1032-07	01-1033-07		01-1035-07	01-1036-07	01-1037-07
185 mm – 7 ¼ "	01-1031-08	01-1032-08	01-1033-08		01-1035-08	01-1036-08	01-1037-08
200 mm – 8 "	01-1031-09	01-1032-09	01-1033-09		01-1035-09	01-1036-09	01-1037-09

Operating scissors



GRAZIL

	Fig. 1	Fig. 2	Fig. 3
130 mm – 5 "	01-1038-01	01-1039-01	01-1040-01
145 mm – 5 ¾ "	01-1038-02	01-1039-02	01-1040-02



GRAZIL

	Fig. 1	Fig. 2	Fig. 3
130 mm – 5 "	01-1041-01	01-1042-01	01-1043
140 mm – 5 ½ "	01-1041-02	01-1042-02	

Operating scissors



DEAVER				
	1:2	1:2	1:2	1:2
140 mm – 5 ½ "	01-1044	01-1045	01-1046	01-1047
	straight	curved	straight, saw edge	curved, saw edge

DEAVER		
	T.C	T.C
140 mm – 5 ½ "	01-1048	01-1049
	straight	curved



LANGE				
	1:2	1:2	1:2	1:2
145 mm – 5 ¾ "	01-1050	01-1051	01-1052	01-1053
	straight	curved	straight, saw edge	curved, saw edge

Operating scissors



MIXTER

1:2



1:2



155 mm – 6"	01-1054	01-1054-02	01-1055-01	01-1055-02
--------------------	---------	------------	------------	------------

straight

straight, saw edge curved

curved, saw edge



LEXER



		Supercut	T.C	T.C / Supercut	Ceramic Cut
160 mm – 6 ¼"	01-1056-01	01-1057	01-1058-01	01-1059	01-1060
210 mm – 8 ¼"	01-1056-02		01-1058-02		



LEXER

		Supercut	T.C	T.C / Supercut	Ceramic Cut
160 mm – 6 ¼"	01-1061-01	01-1062	01-1063-01	01-1064	01-1065
210 mm – 8 ¼"	01-1061-02		01-1063-02		

Operating scissors



RICHTER

1:2

145 mm – 5 ¾ "	01-1066
----------------	---------



FERGUSSON

140 mm – 5 ½ "	01-1067-01
160 mm – 6 ¼ "	01-1067-02
180 mm – 7 "	01-1067-03



130 mm – 5 "	01-1068-01
145 mm – 5 ¾ "	01-1068-02

Operating scissors – Dissecting scissors



MAYO

		Supercut	T.C	T.C/ Supercut	Ceramic Cut
145 mm – 5 ¾ "	01-1069-01	01-1070-01	01-1071-01	01-1072-01	01-1073-01
150 mm – 6 "	01-1069-02	01-1070-02	01-1071-02	01-1072-02	
170 mm – 6 ¾ "	01-1069-03	01-1070-03	01-1071-03	01-1072-03	01-1073-02
230 mm – 9 "	01-1069-04		01-1071-04	01-1072-04	01-1073-03



MAYO

		Supercut	T.C	T.C/ Supercut	Ceramic Cut
145 mm – 5 ¾ "	01-1074-01	01-1075-01	01-1076-01	01-1077-01	01-1078-01
150 mm – 6 "	01-1074-02	01-1075-02	01-1076-02	01-1077-02	
170 mm – 6 ¾ "	01-1074-03	01-1075-03	01-1076-03	01-1077-03	01-1078-02
200 mm – 8 "			01-1076-04	01-1077-04	
230 mm – 9 "	01-1074-04		01-1076-05	01-1077-05	01-1078-03

Operating scissors – Dissecting scissors



MAYO-STILLE

		Supercut	T.C	T.C / Supercut	Ceramic Cut
150 mm – 6 "	01-1079-01	01-1080-01	01-1081-01	01-1082-01	01-1083-01
170 mm – 6 ¾ "	01-1079-02	01-1080-02	01-1081-02	01-1082-02	01-1083-02
190 mm – 7 ½ "	01-1079-03		01-1081-02	01-1082-03	
210 mm – 8 ¾ "	01-1079-04		01-1081-02	01-1082-04	



MAYO-STILLE

		Supercut	T.C	T.C / Supercut	Ceramic Cut
150 mm – 6 "	01-1084-01	01-1085-01	01-1086-01	01-1087-01	01-1088-01
170 mm – 6 ¾ "	01-1084-02	01-1085-02	01-1086-02	01-1087-02	01-1088-02
190 mm – 7 ½ "	01-1084-03		01-1086-03	01-1087-03	
210 mm – 8 ¾ "	01-1084-04		01-1086-04	01-1087-04	

Operating scissors – Dissecting scissors

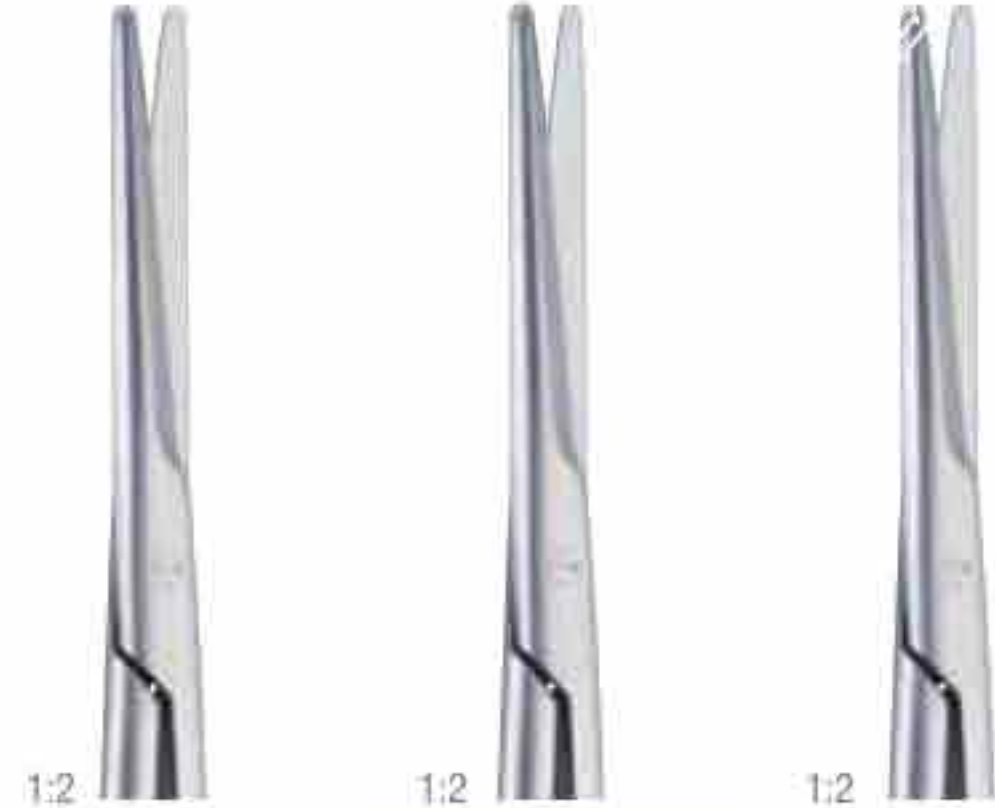

MAYO-HARRINGTON

		Supercut	T.C
230 mm – 9"	01-1089	01-1090	01-1091



MAYO-HARRINGTON

		Supercut	T.C
230 mm – 9"	01-1092	01-1093	01-1094



MAYO-NOBLE

170 mm – 6 3/4"	01-1095	01-1096
-----------------	---------	---------

Operating scissors – Dissecting scissors



WERTHEIM

		T.C
145 mm – 5 ¾ "	01-1097-01	
195 mm – 7 ⅔ "	01-1097-02	
225 mm – 8 ¾ "	01-1097-03	01-1097-04



METZENBAUM

		Supercut	T.C / Supercut
150 mm – 6 "	01-1098	01-1099	01-1100

straight



METZENBAUM

		Supercut	T.C / Supercut	Ceramic Cut
150 mm – 6 "	01-1101	01-1102	01-1103	01-1104

curved

Operating scissors – Dissecting scissors



METZENBAUM

		Supercut	T.C	Ceramic Cut
	Fig. 1	Fig. 1	Fig. 1	Fig. 1
115 mm – 4 ½ "	01-1105-01	01-1106-01	01-1107-01	01-1108-01
145 mm – 5 ¾ "	01-1105-02	01-1106-02	01-1107-02	01-1108-02



METZENBAUM

		T.C		T.C
	Fig. 2	Fig. 2	Fig. 3	Fig. 3
145 mm – 5 ¾ "	01-1109	01-1110	01-1111	01-1112

Operating scissors – Dissecting scissors



METZENBAUM

		Supercut	T.C	Ceramic Cut
	Fig. 1	Fig. 1	Fig. 1	Fig. 1
115 mm – 4 ½ "	01-1113-01	01-1114-01	01-1115-01	01-1116-01
145 mm – 5 ¾ "	01-1113-02	01-1114-02	01-1115-02	01-1116-02



METZENBAUM

		T.C		T.C
	Fig. 2	Fig. 2	Fig. 3	Fig. 3
145 mm – 5 ¾ "	01-1117	01-1118	01-1119	01-1120

Operating scissors – Dissecting scissors

METZENBAUM-NELSON



		Supercut	T.C	T.C / Supercut	Ceramic Cut
	Fig. 1	Fig. 1	Fig. 1	Fig. 1	Fig. 1
180 mm – 7"	01-1121-01	01-1122-01	01-1123-01	01-1124-01	01-1125-01
200 mm – 8"	01-1121-02	01-1122-02	01-1123-02	01-1124-02	01-1125-02
230 mm – 9"	01-1121-03	01-1122-03	01-1123-03	01-1124-03	01-1125-03
250 mm – 9 3/4"	01-1121-04	01-1122-04	01-1123-04	01-1124-04	
280 mm – 11"	01-1121-05		01-1123-05	01-1124-05	
300 mm – 12"	01-1121-06		01-1123-06	01-1124-06	



METZENBAUM-NELSON



		T.C	T.C	T.C
	Fig. 2	Fig. 2	Fig. 3	Fig. 3
180 mm – 7"	01-1126-01	01-1127-01	01-1128-01	01-1128-01
200 mm – 8"	01-1126-02	01-1127-02	01-1128-02	01-1128-02
230 mm – 9"	01-1126-03	01-1127-03	01-1128-03	01-1128-03
250 mm – 9 3/4"	01-1126-04	01-1127-04	01-1128-04	01-1128-04
280 mm – 11"	01-1126-05	01-1127-05	01-1128-05	01-1128-05
300 mm – 12"	01-1126-06	01-1127-06	01-1128-06	01-1128-06

Operating scissors – Dissecting scissors

METZENBAUM-
NELSON



		Supercut	T.C	T.C / Supercut	Ceramic Cut
	Fig. 1	Fig. 1	Fig. 1	Fig. 1	Fig. 1
180 mm – 7 "	01-1129-01	01-1130-01	01-1131-01	01-1132-01	01-1133-01
200 mm – 8 "	01-1129-02	01-1130-02	01-1131-02	01-1132-02	01-1133-02
230 mm – 9 "	01-1129-03	01-1130-03	01-1131-03	01-1132-03	01-1133-03
250 mm – 9 ¾ "	01-1129-04	01-1130-04	01-1131-04	01-1132-04	01-1133-04
280 mm – 11 "	01-1129-05		01-1131-05	01-1132-05	
300 mm – 12 "	01-1129-06		01-1131-06	01-1132-06	01-1133-05



METZENBAUM-
NELSON



		T.C		T.C
	Fig. 2	Fig. 2	Fig. 3	Fig. 3
180 mm – 7 "	01-1134-01	01-1135-01	01-1136-01	01-1137-01
200 mm – 8 "	01-1134-02	01-1135-02	01-1136-02	01-1137-02
230 mm – 9 "	01-1134-03	01-1135-03	01-1136-03	01-1137-03
250 mm – 9 ¾ "	01-1134-04	01-1135-04	01-1136-04	01-1137-04
280 mm – 11 "	01-1134-05	01-1135-05	01-1136-05	01-1137-05
300 mm – 12 "	01-1134-06	01-1135-06	01-1136-06	01-1137-06

Operating scissors – Dissecting scissors



METZENBAUM-FINO

	Fig. 1	Fig. 3	Fig. 1	Fig. 3
145 mm – 5 ¼ "	01-1138-01	01-1139	01-1140-01	01-1141-01

	Ceramic Cut	Ceramic Cut	Ceramic Cut	Ceramic Cut
	Fig. 1	Fig. 3	Fig. 1	Fig. 3
145 mm – 5 ¼ "	01-1138-02		01-1140-02	01-1141-02



METZENBAUM-FINO

	T.C	T.C	T.C	T.C
	Fig. 1	Fig. 3	Fig. 1	Fig. 3
145 mm – 5 ¼ "	01-1142	01-1143	01-1144	01-1145



METZENBAUM-FINO

	Supercut	Supercut
	Fig. 1	Fig. 1
145 mm – 5 ¼ "	01-1146	01-1147

Operating scissors – Dissecting scissors

METZENBAUM-FINO



		Supercut	T.C
180 mm – 7 "	01-1148-01	01-1149-01	01-1150-01
200 mm – 7 ¾ "	01-1148-02	01-1149-02	01-1150-02
230 mm – 9 "	01-1148-03	01-1149-03	01-1150-03
250 mm – 10 "			01-1150-04
280 mm – 11 "			01-1150-05

METZENBAUM-FINO



		T.C
180 mm – 7 "	01-1151-01	01-1152-01
220 mm – 8 "	01-1151-02	01-1152-02
230 mm – 9 "	01-1151-03	01-1152-03

S-curved

S-curved



METZENBAUM-FINO

		Supercut	T.C	T.C / Supercut	Ceramic Cut
180 mm – 7 "	01-1153-01	01-1154-01	01-1155-01	01-1156	01-1157-01
200 mm – 7 ¾ "	01-1153-02	01-1154-02	01-1155-02		01-1157-02
230 mm – 9 "	01-1153-03	01-1154-03	01-1155-03		01-1157-03
250 mm – 10 "			01-1155-04		
260 mm – 10 ¼ "					01-1157-04
280 mm – 11 "			01-1155-05		
300 mm – 12 "					01-1157-05

Operating scissors – Dissecting scissors



GOLDMANN-FOX

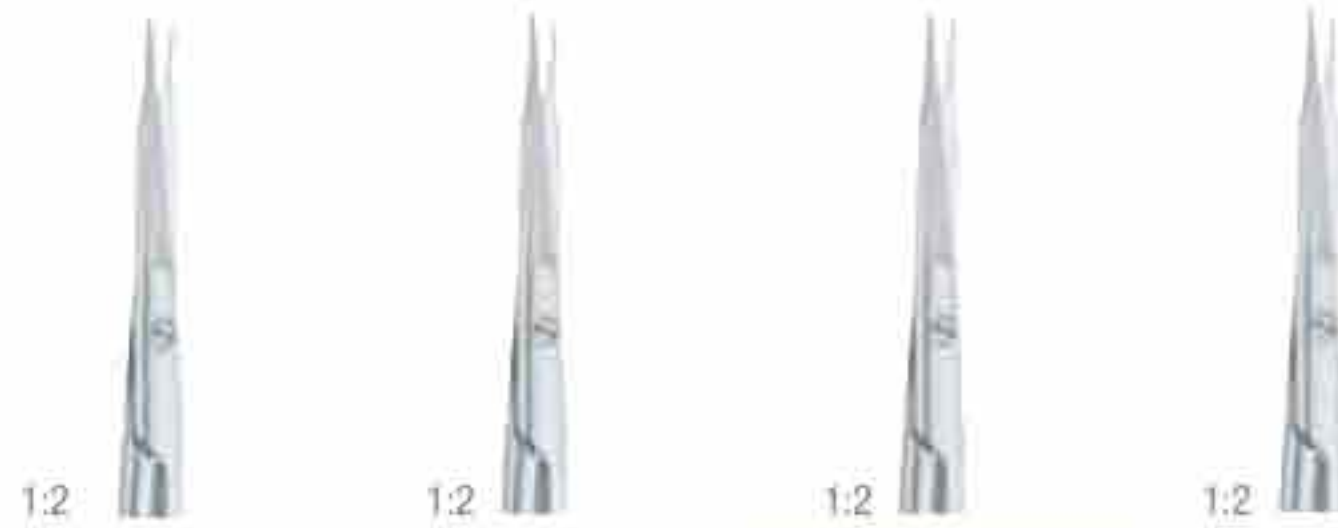

			Supercut	T.C
130 mm – 5 "	01-1158	01-1159	01-1160	01-1161

saw edge

straight

GOLDMANN-FOX



			Supercut	T.C
130 mm – 5 "	01-1162	01-1163	01-1164	01-1165

saw edge

curved

Dissecting scissors



FOMON

1:2

140 mm – 5 ½ "	01-1166
----------------	---------



THOREK

185 mm – 7 ⅓ "	01-1167-01
250 mm – 9 ¾ "	01-1167-02

Gynecological scissors



SIMS

		Supercut	T.C	
	Fig. 1	Fig. 1	Fig. 1	Fig. 2
200 mm – 8"	01-1168-01	01-1169-01	01-1170-01	01-1171-01
230 mm – 9"	01-1168-02	01-1169-02	01-1170-02	01-1171-02



SIMS

		Supercut	T.C	
	Fig. 1	Fig. 1	Fig. 1	Fig. 2
200 mm – 8"	01-1172-01	01-1173-01	01-1174-01	01-1175-01
230 mm – 9"	01-1172-02	01-1173-02	01-1174-02	01-1175-02

Gynecological scissors



DUBOIS

270 mm – 10 3/4"	01-1176	01-1177
------------------	---------	---------



DOYEN

175 mm – 7"	01-1178	01-1179
-------------	---------	---------



SIEBOLD

240 mm – 9 1/2"	01-1180	Supercut 01-1181
-----------------	---------	----------------------------



S-curved

S-curved

Fine operating scissors



	Fig. 1	Fig. 2	Fig. 3
120 mm – 4 3/4 "	01-1182	01-1183	01-1184



	Fig. 1	Fig. 2	Fig. 3
120 mm – 4 3/4 "	01-1185	01-1186	01-1187

KNAPP

105 mm – 4 3/4 "	01-1188	01-1189
------------------	---------	---------

blunt



KNAPP

		Ceramic Cut		Ceramic Cut
105 mm – 4 3/4 "	01-1190		01-1192	
120 mm – 4 3/4 "		01-1191		01-1193

sharp

Fine scissors



1:2



1:2



1:2



1:2



1:2

WAGNER

		Supercut		Supercut
120 mm – 4 3/4 "	01-1194	01-1195	01-1196	01-1197

straight

curved



1:2



1:2



1:2

BROPHY
(SULLIVAN)

145 mm – 5 3/4 "	01-1198	01-1199
-------------------------	---------	---------



LITTLER



115 mm – 4 1/2 "	01-1200-01
145 mm – 5 3/4 "	01-1200-02

Fine scissors



NEUMANN

120 mm – 4 ¾ "	01-1201
----------------	---------

S-curved



QUINBY

125 mm – 5 "	125 mm – 5 "
01-1181-01	01-1202

straight

curved



LOCKLIN

		T.C		T.C
165 mm – 6 ½ "	01-1203	01-1204	01-1205	01-1206

saw edge

Fine scissors



REYNOLDS

		Supercut	T.C
150 mm – 6 "	01-1207-01	01-1208-01	01-1209-01
180 mm – 7 "	01-1207-02	01-1208-02	01-1209-02



REYNOLDS

		Supercut	T.C	Ceramic Cut
150 mm – 6 "	01-1210-01	01-1211-01	01-1212-01	01-1213-01
180 mm – 7 "	01-1210-02	01-1211-02	01-1212-02	01-1213-02

Fine scissors

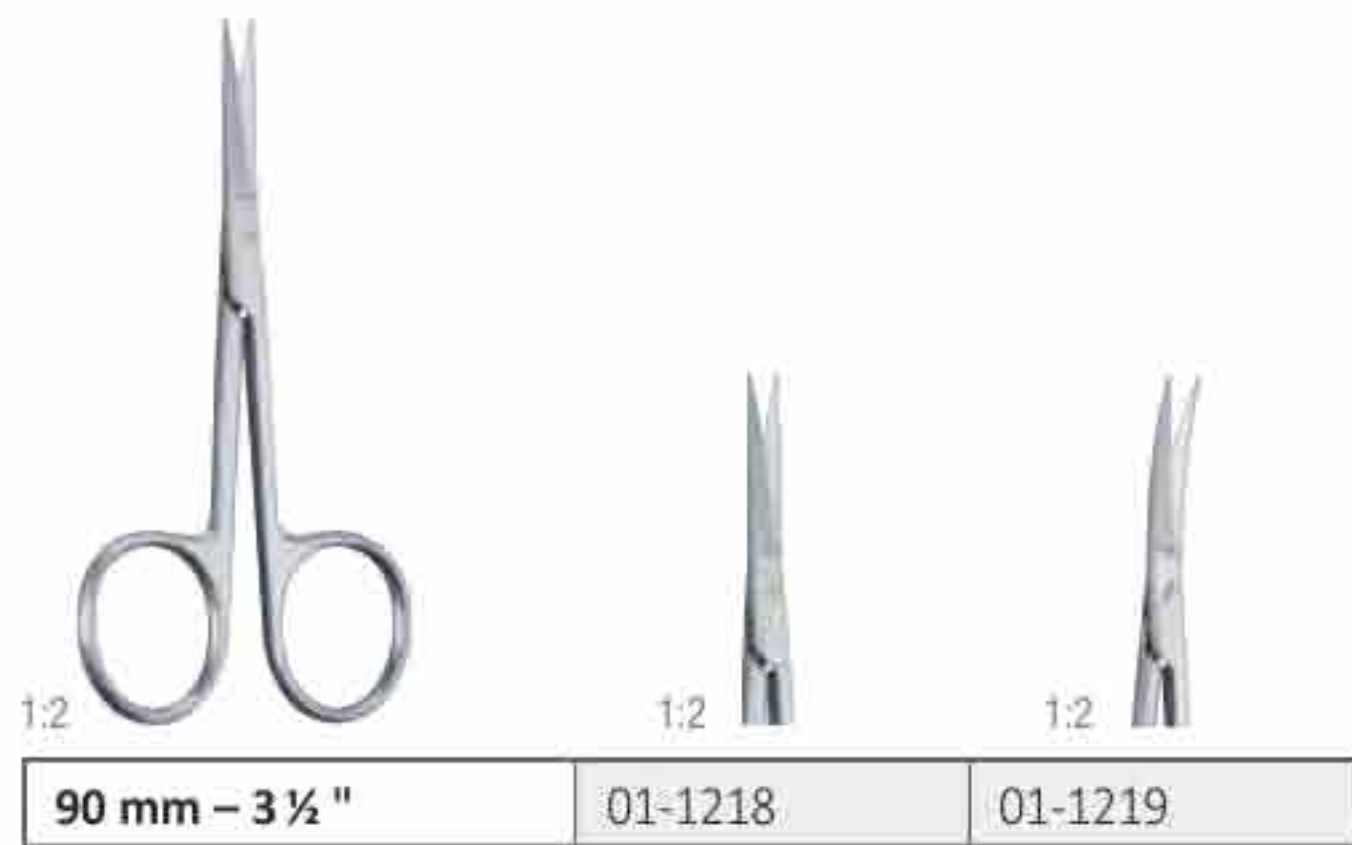
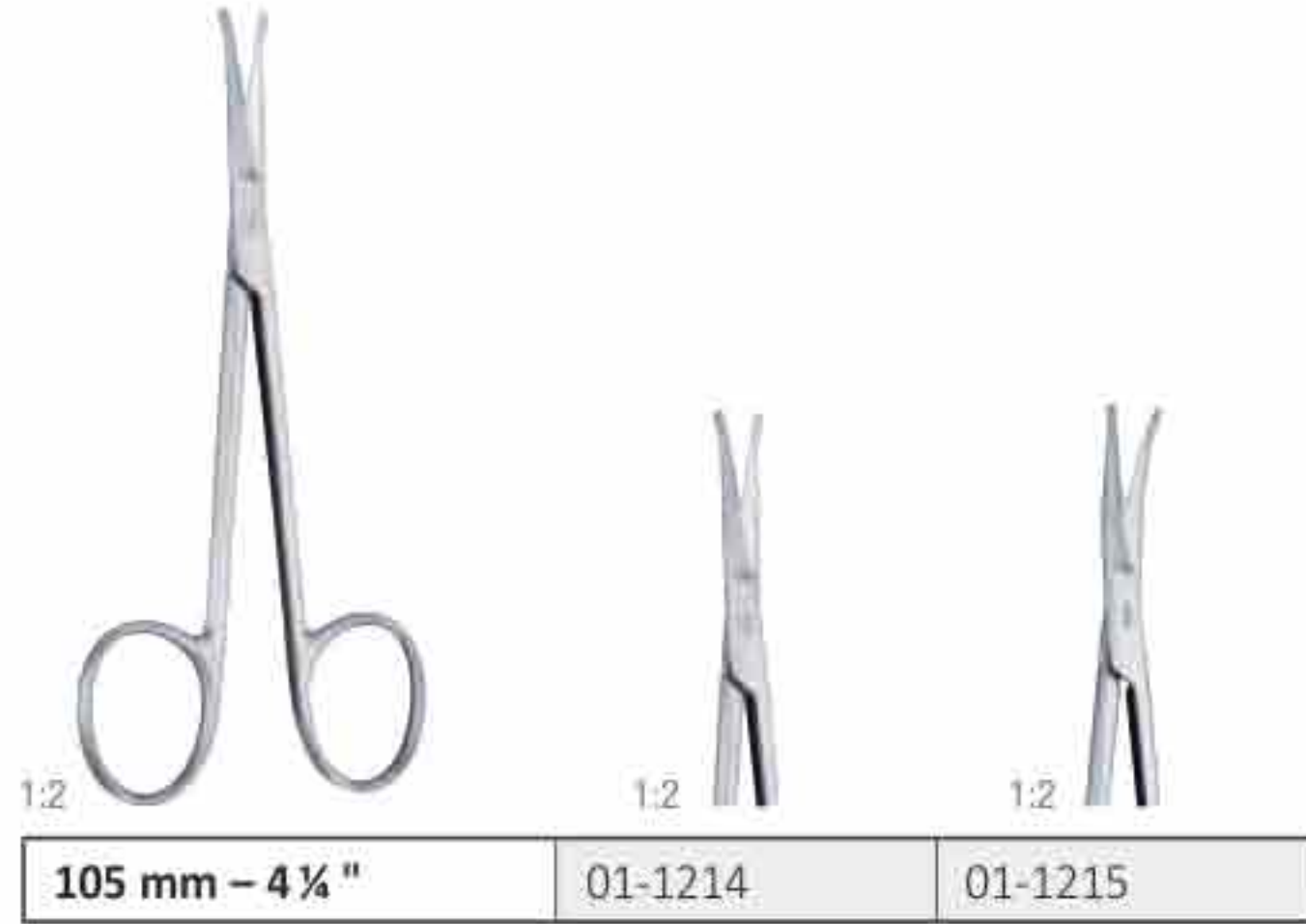

Fine scissors



		Supercut	T.C	T.C/ Supercut	Ceramic Cut
90 mm – 3 ½ "	01-1220-01	01-1221-01	01-1222-01	01-1223-01	
105 mm – 4 ¼ "	01-1220-02		01-1222-02	01-1223-02	
115 mm – 4 ½ "	01-1220-03	01-1221-02	01-1222-03	01-1223-03	01-1224
120 mm – 4 ¾ "	01-1220-04		01-1222-04	01-1223-04	



		Supercut	T.C	T.C/ Supercut	Ceramic Cut
90 mm – 3 ½ "	01-1225-01	01-1226-01			
105 mm – 4 ¼ "	01-1225-02			01-1228	
115 mm – 4 ½ "	01-1225-03	01-1226-02	01-1227		01-1229
120 mm – 4 ¾ "	01-1225-04				



115 mm – 4 ½ "	01-1230	01-1231
----------------	---------	---------

laterally curved

laterally angled

Fine scissors

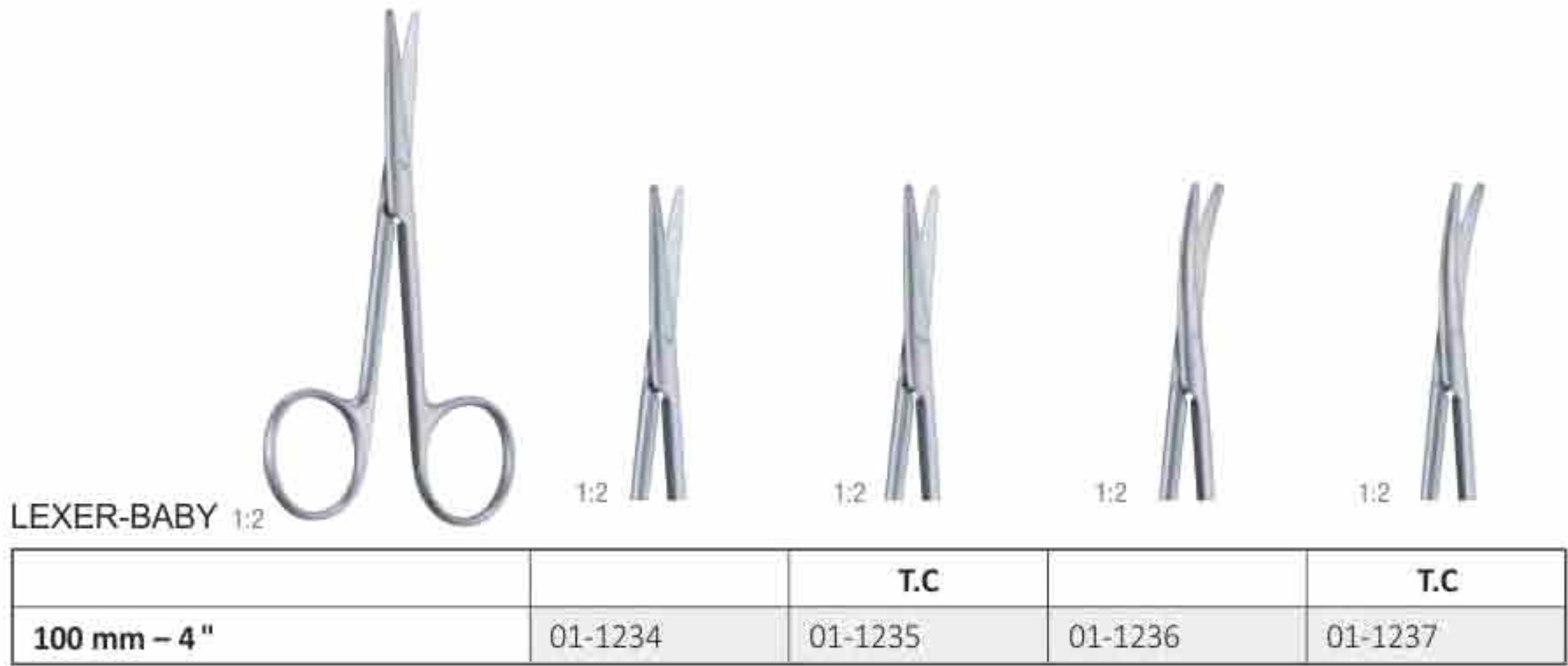

straight

curved

Fistula scissors



KELLY

		Supercut	T.C	Ceramic Cut
160 mm – 6 ¼ "	01-1238-01	01-1239-01	01-1240-01	
180 mm – 7 "	01-1238-02	01-1239-02	01-1240-02	01-1241



KELLY

		Supercut	T.C	Ceramic Cut
160 mm – 6 ¼ "	01-1242-01	01-1243-01	01-1244-01	
180 mm – 7 "	01-1242-02	01-1243-02	01-1244-02	01-1245

Eucleation scissors



LANDOLDT

125 mm – 5"	01-1246	01-1247
-------------	---------	---------

slight curved

strong curved



		Ceramic Cut		Ceramic Cut
115 mm – 4 ½"	01-1248	01-1249	01-1250	01-1251

straight

curved



CHADWICK 1:2

110 mm – 4 ¼"
01-1252

Plastic surgery scissors

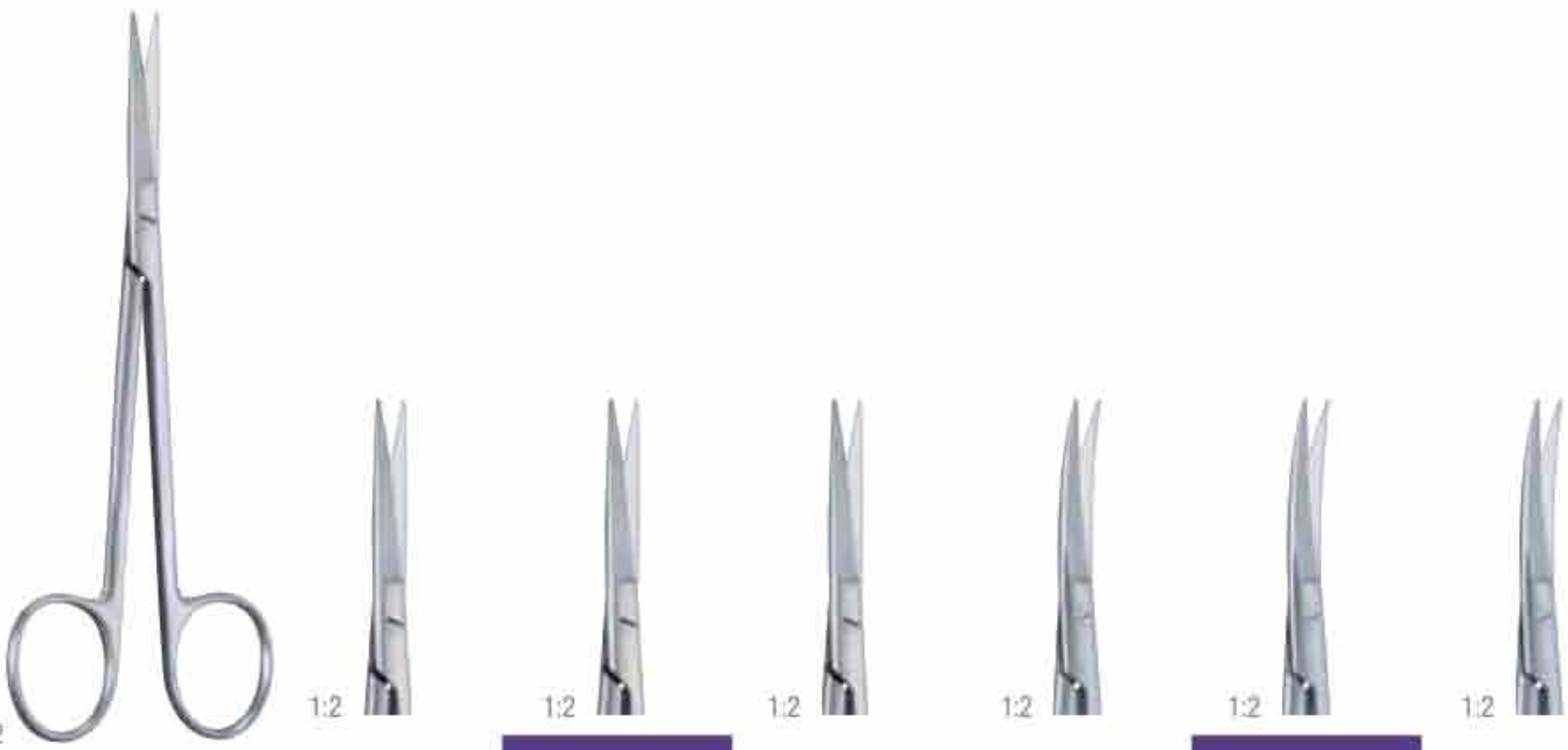

JOSEPH 1:2

		Supercut	T.C		Supercut	T.C
140 mm – 5 ½ "	01-1253	01-1254	01-1255	01-1256	01-1257	01-1258



KILNER (RAGNELL)

		T.C
120 mm – 4 ¾ "	01-1259-01	01-1260-01
150 mm – 6 "	01-1259-02	01-1260-02

Plastic surgery scissors

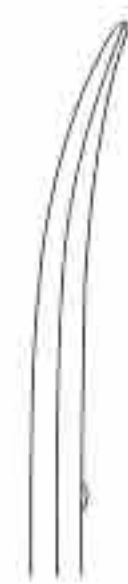

GORNEY

		T.C		T.C	Ceramic Cut
120 mm – 4 ¾ "	01-1261-01				
170 mm – 6 ¾ "					01-1265-01
190 mm – 7 ½ "	01-1261-02	01-1262	01-1263	01-1264	01-1265-02
230 mm – 9 "					01-1265-03



1:2

KAYE

	T.C
115 mm – 4 ½ "	01-1266

Artery scissors



1:2

145 mm - 5 3/4"	01-1267
-----------------	---------

1 Blade with probe



LINCOLN 1:2

170 mm - 6 3/4"	01-1268	01-1269
-----------------	---------	---------

1:2



1:2

115 mm - 4 1/2"	01-1270
-----------------	---------



FUTON 1:2

170 mm - 6 3/4"	01-1271
-----------------	---------



POTTS-SMITH
(DE MARTEL)

1:2

195 mm - 7 3/4"	01-1272
-----------------	---------

Artery scissors

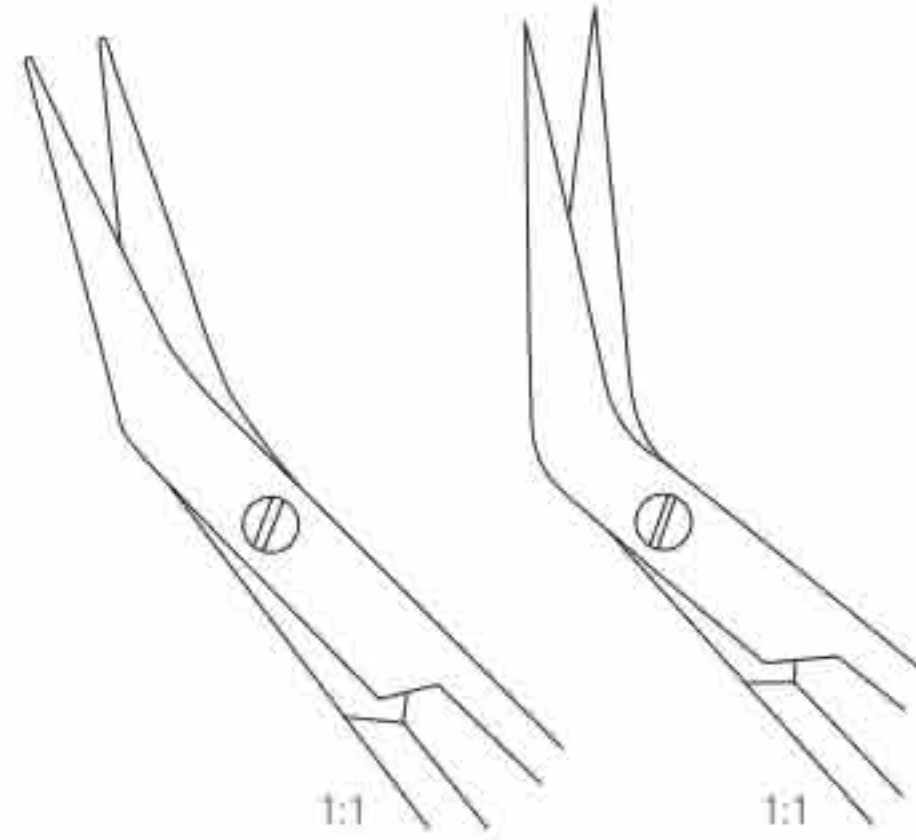

Offset scissors, s-shaped

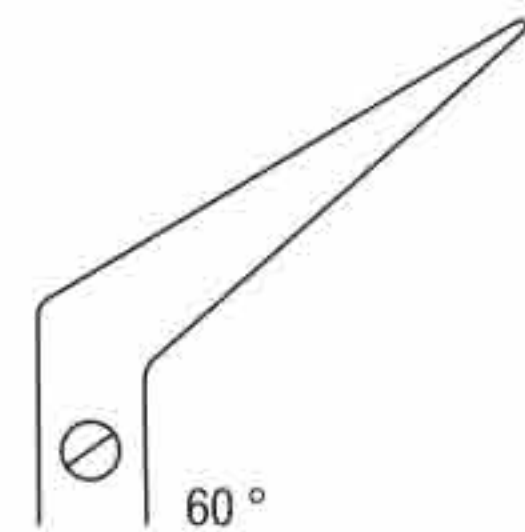
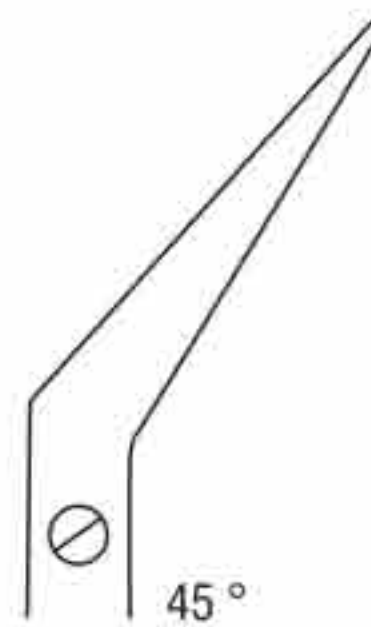

		T.C		T.C		T.C
160 mm – 6 ¼"	01-1277-01	01-1278-01	01-1279-01	01-1280-01	01-1281-01	01-1282-01
230 mm – 9"	01-1277-02	01-1278-02	01-1279-02	01-1280-02	01-1281-02	01-1282-02
280 mm – 11"	01-1277-03	01-1278-03	01-1279-03	01-1280-03	01-1281-03	01-1282-03

Artery scissors

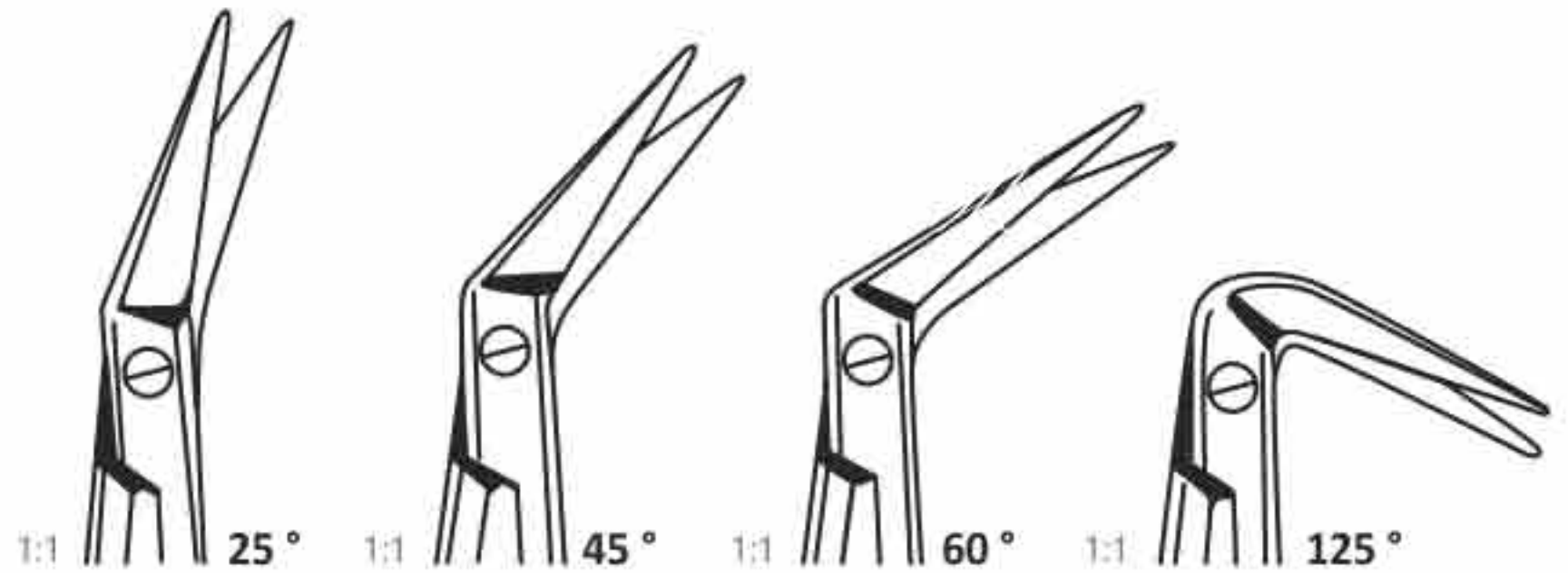

POTTS-SMITH	1:1	25°	1:1	45°	1:1	60°	1:1	125°
190 mm – 7 ½ "	01-1283		01-1284		01-1285		01-1286	

POTTS-SMITH			
	Supercut	Supercut	Supercut
190 mm – 7 ½ "	01-1287-01	01-1288-01	01-1289-01

POTTS-SMITH			
	Ceramic Cut	Ceramic Cut	Ceramic Cut
190 mm – 7 ½ "	01-1287-02	01-1288-02	01-1289-02



POTTS-SMITH	1:1	25°	1:1	45°	1:1	60°
		T.C		T.C		T.C
190 mm – 7 ½ "	01-1290		01-1291		01-1292	



180 mm – 7 "	01-1293	01-1294	01-1295	01-1296	01-1297
---------------------	---------	---------	---------	---------	---------

1:1	25°	1:1	45°	1:1	60°	1:1	90°	1:1	125°
01-1298-01		01-1299-01		01-1300-01		01-1301-01		01-1302-01	

Ceramic Cut	Ceramic Cut	Ceramic Cut	Ceramic Cut	Ceramic Cut
01-1298-02	01-1299-02	01-1300-02	01-1301-02	01-1302-02

Artery scissors

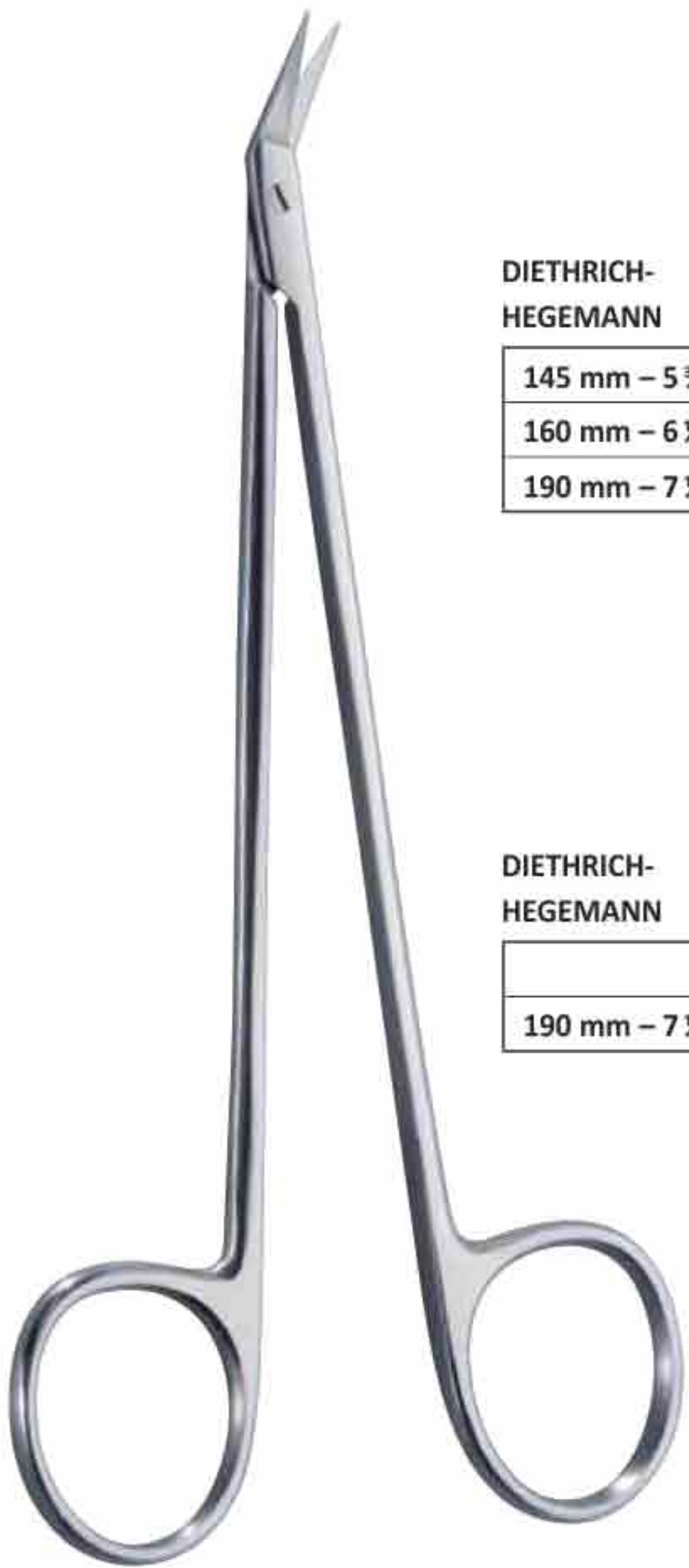

DIETRICH-HEGEMANN

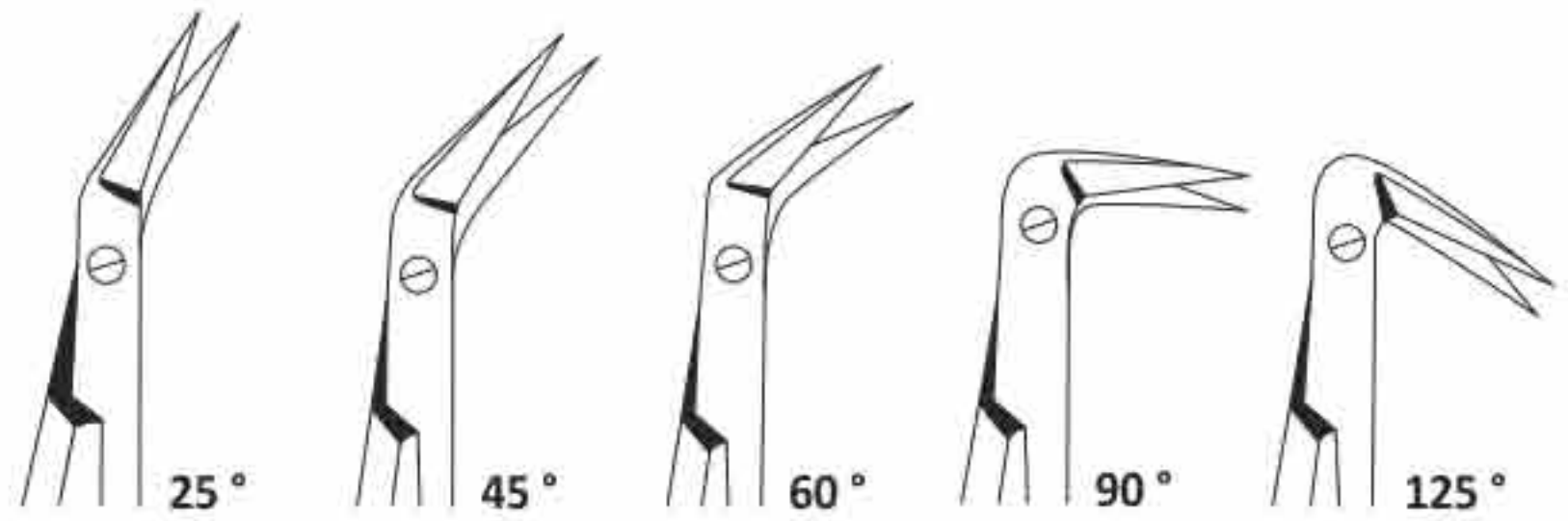

145 mm – 5 ¾ "	01-1303-01	01-1304-01	01-1305-01	01-1306-01	01-1306-01
160 mm – 6 ¼ "	01-1303-02	01-1304-02	01-1305-02	01-1306-02	01-1306-02
190 mm – 7 ½ "	01-1303-03	01-1304-03	01-1305-03	01-1306-03	01-1306-03

DIETRICH-HEGEMANN

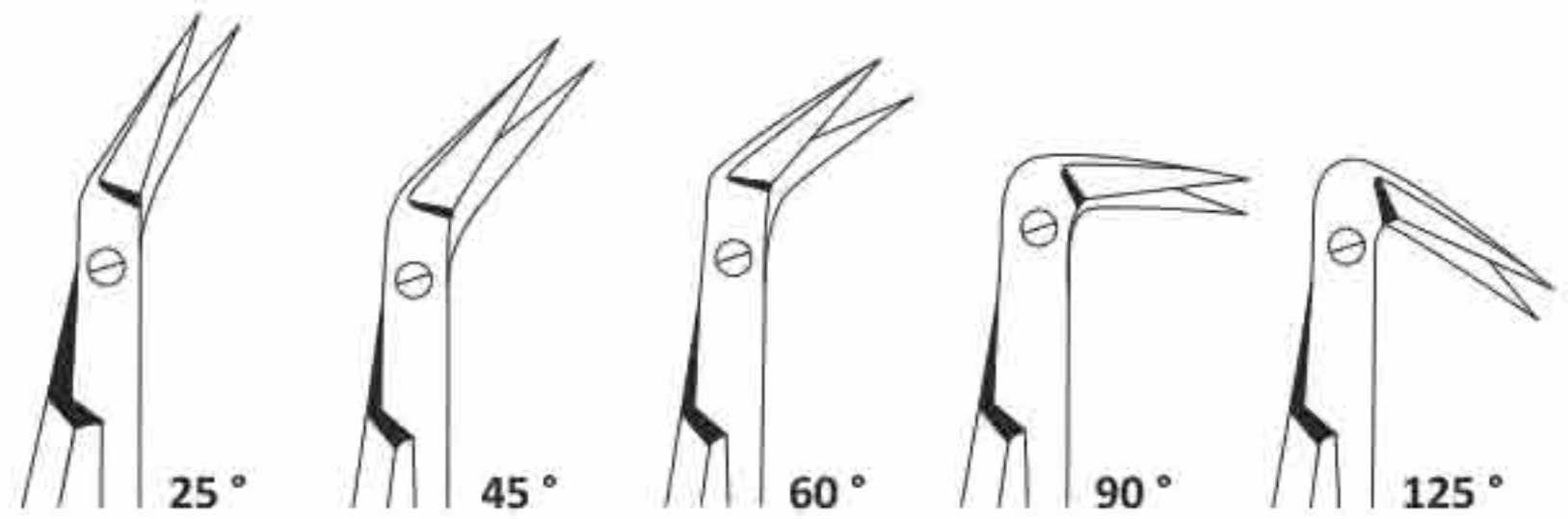

	Ceramic Cut	Ceramic Cut	Ceramic Cut	Ceramic Cut	Ceramic Cut
190 mm – 7 ½ "	01-1307	01-1308	01-1309	01-1310	01-1311

Cartilage scissors



1:2

MARTIN-C ARTILAGE

200 mm – 8"	01-1312
-------------	---------



1:2

MCINDOE

190 mm – 7½"	01-1313
--------------	---------



POTTS-SMITH

190 mm – 7½"	01-1314
--------------	---------

curved, saw edge

Tonsil scissors



TOENNIS 1:2

180 mm - 7"	01-1315	01-1316
--------------------	---------	---------



1:2



1:2



PRINCE 1:2

175 mm - 7"	01-1317
--------------------	---------



BOETTCHER 1:2

180 mm - 7"	01-1318
--------------------	---------



TOENNIS-ADSON 1:2

		T.C	Ceramic Cut
170 mm - 6 3/4"	01-1319	01-1320	01-1321



1:2



1:2

Tonsil scissors



DEAN

1:2

			T.C
170 cm - 6 3/4"	01-1322	01-1323	01-1324

curved

curved, saw edge

curved, saw edge



1:2

WERTHEIM

140 mm - 5 1/4"	01-1325-01
190 mm - 7 1/2"	01-1325-02



GOOD

190 mm - 7 1/2"	01-1327
-----------------	---------



1:2



1:1

OLIVECRONA

230 mm - 9"	01-1326
-------------	---------

Trigeminal scissors



1:2

Lobectomy scissors



CRAFOORD 1:3

300 mm – 12"	01-1328
--------------	---------



WILLAUER

250 mm – 9 3/4"	01-1329-01	01-1330-01
280 mm – 11"	01-1329-02	01-1330-02

straight curved



FINOCHIETTO 1:3

270 mm – 10 3/4"	01-1331
------------------	---------



RESANO

250 mm – 10"	01-1332
--------------	---------

Thorax scissors



1:2

SATINSKY

245 mm – 9 ¾"	01-1333
---------------	---------



1:2

KLINKENBERGH-LOTH

230 mm – 9"	01-1334
-------------	---------



JORGENSON

220 mm – 8 ¾"	01-1335
---------------	---------

Nasal scissors



SEILER	1:2		
170 mm – 6 ¾ "		01-1336	



COTTLE	1:2	1:2	1:2
		Supercut	Ceramic Cut
160 mm – 6 ¼ "	01-1337	01-1338	01-1339



FOMON	1:2	1:2	1:2
		Supercut	Ceramic Cut
130 mm – 5 "	01-1340	01-1341	01-1342



HEYMANN	1:2	
		Supercut
180 mm – 7 "	01-1343	01-1344

Micro scissors



NOYES



	Fig. 1	Fig. 2	Fig. 3
120 mm - 4 3/4"	01-1345	01-1346	01-1347

straight sharp - sharp sharp - blunt blunt - blunt



NOYES

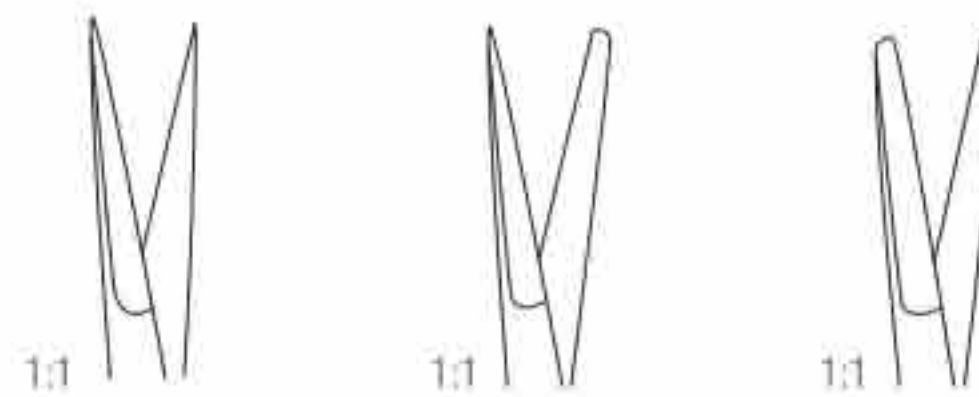

	Fig. 1	Fig. 2	Fig. 3
120 mm - 4 3/4"	01-1348	01-1349	01-1350

angulated sharp - sharp sharp - blunt blunt - blunt

Micro scissors



1:1

120 mm – 4 3/4"	01-1351
-----------------	---------



1:1

WECKER

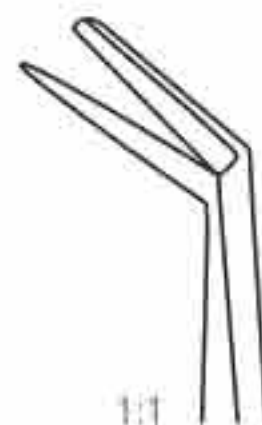

1:1

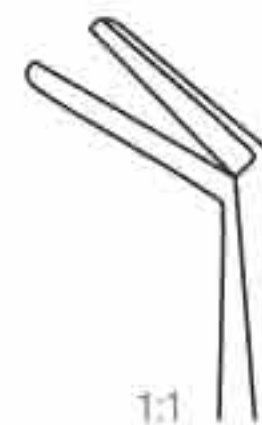

1:1

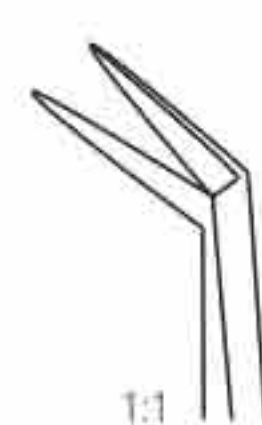

1:1

	Fig. 1	Fig. 2	Fig. 3
110 mm – 4 1/4"	01-1353	01-1354	01-1355

sharp – blunt

blunt – blunt

sharp – sharp



1:1

BARRAQUER

	55 mm – 2 1/4"
x = 5 mm	01-1352-01
x = 7 mm	01-1352-02
x = 10 mm	01-1352-03

Micro scissors



WESTCOTT 1:1

115 mm - 4 1/2"



1:1

01-1356



1:1

01-1357



CASTROVIEJO 1:1

90 mm - 3 1/2"

01-1358

Micro scissors

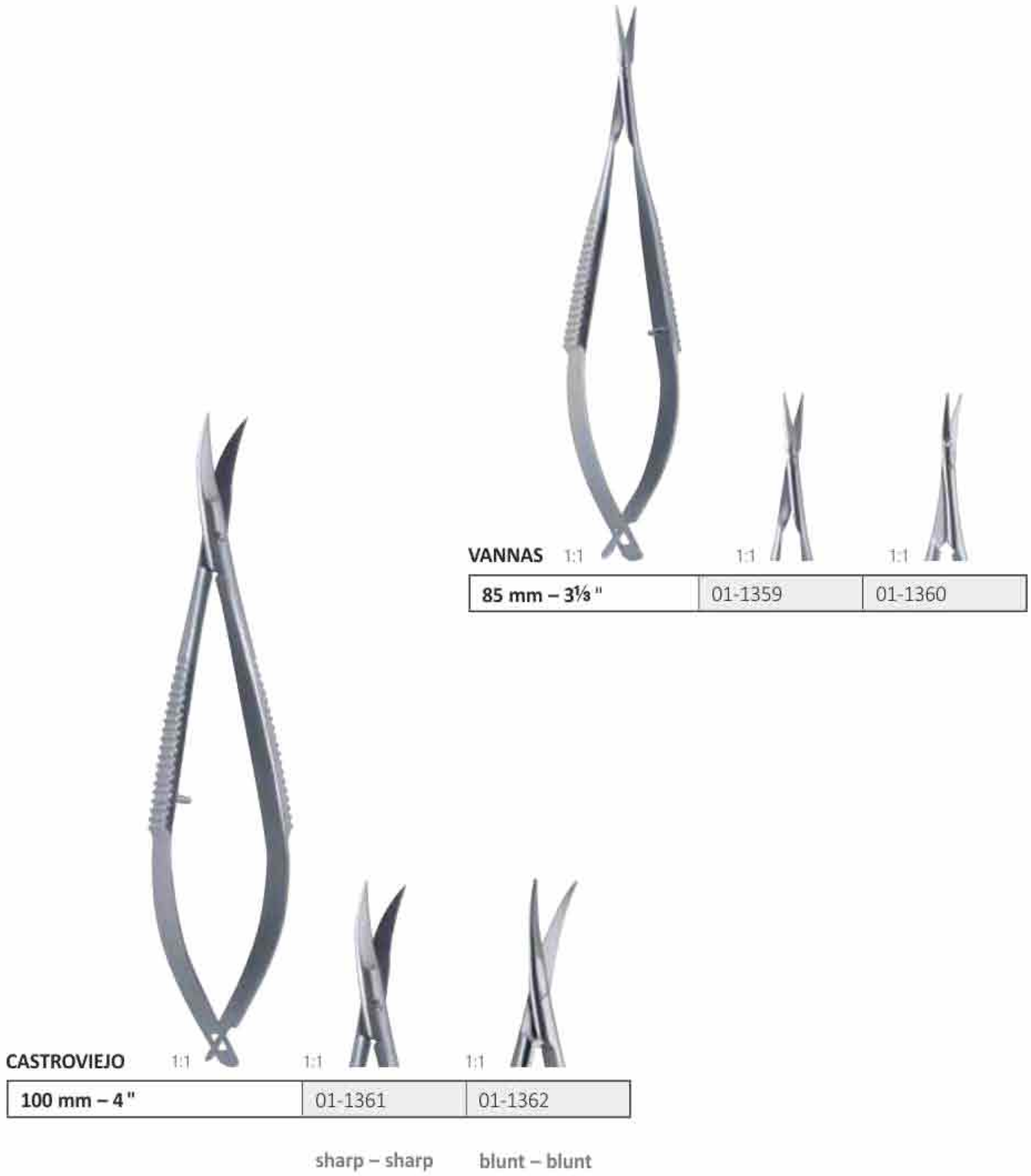

Tenotomy scissors



WESTCOTT

1:1



1:1



110 mm – 4 1/4 "	01-1363	01-1364
-------------------------	---------	---------

sharp – sharp

blunt – blunt

Iris scissors



120 mm – 4 ¾ "	01-1365	01-1366
-----------------------	---------	---------



	Supercut	Supercut
115 mm – 4 ½ "	01-1367	01-1368

straight

curved

Iris scissors



		T.C	Ceramic Cut		T.C	Ceramic Cut
115 mm - 4 1/2 "	01-1369	01-1370	01-1371	01-1372	01-1373	01-1374
	straight	straight	straight	curved	curved	curved



		T.C	
115 mm - 4 1/2 "	01-1375	01-1376	01-1377
	angular	angular	laterally curved

Tenotomy scissors

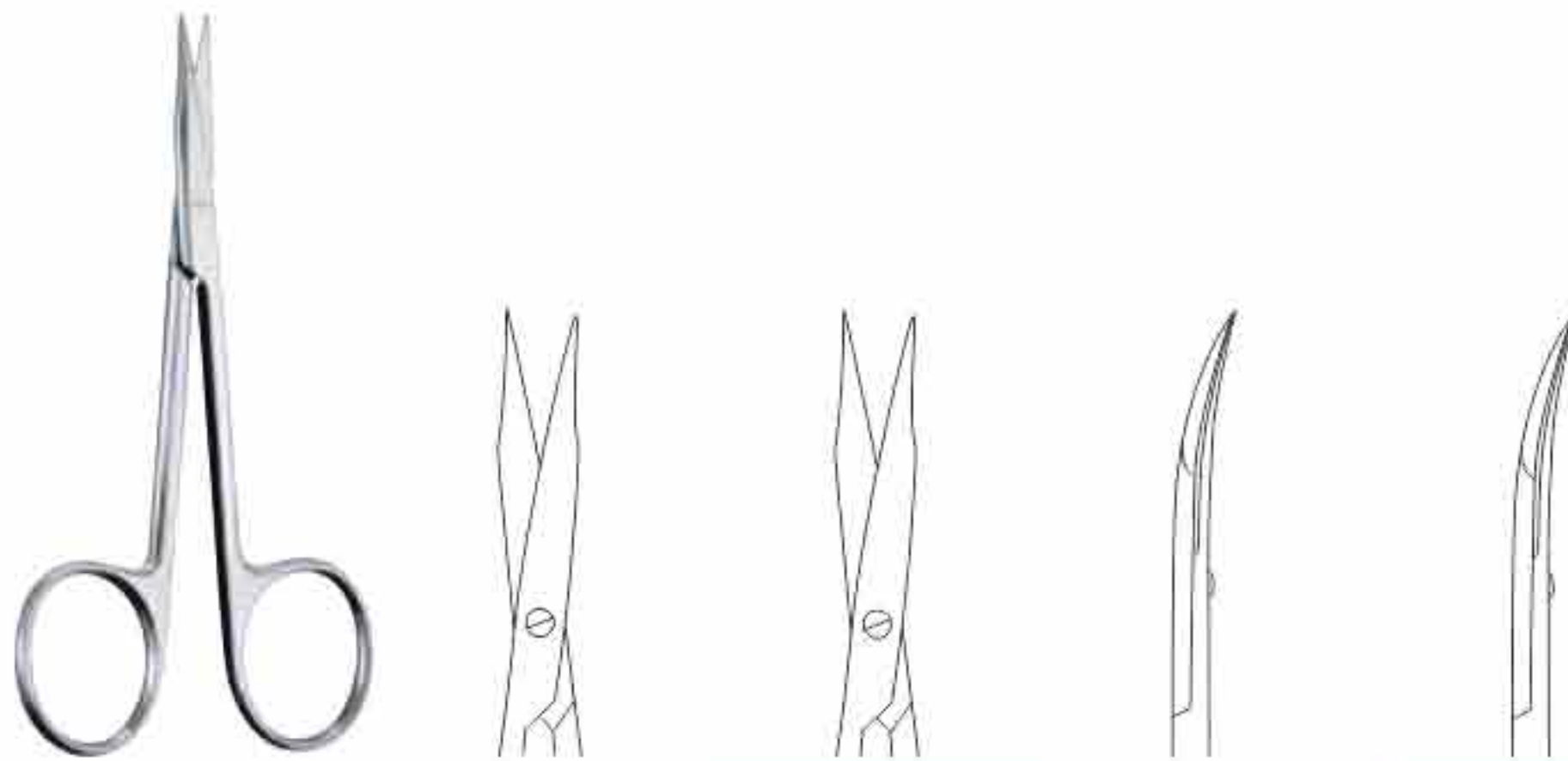

STEVENS

		Supercut		Supercut
90 mm – 3 ½ "	01-1378-01			
100 mm – 4 "	01-1378-02	01-1379-01	01-1380-01	01-1381-01
110 mm – 4 ¼ "	01-1378-03	01-1379-02	01-1380-02	01-1381-02

sharp – sharp

Tenotomy scissors

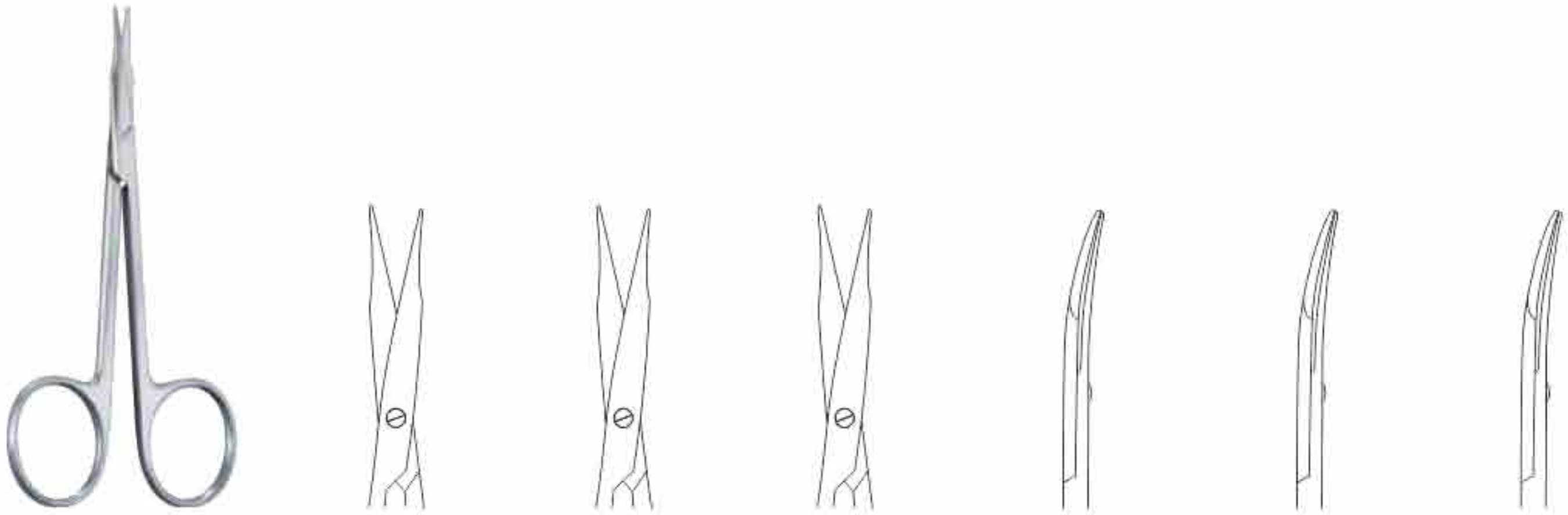

STEVENS

		Supercut	Ceramic Cut		Supercut	Ceramic Cut
90 mm – 3 ½ "	01-1382-01					
100 mm – 4 "	01-1382-02			01-1385-01		
110 mm – 4 ¼ "	01-1382-03	01-1383	01-1384-01	01-1385-02	01-1386	01-1387-01
130 mm – 5 "			01-1384-02			01-1387-02

blunt – blunt

WALTON

1:2



100 mm – 4 "

01-1388

GRAEFE

1:2



105 mm – 4 ¼ "

01-1389

Strabismus scissors



		Supercut	T.C	T.C / Supercut
115 mm – 4 ½ "	01-1390	01-1391	01-1392	01-1393



		Supercut	T.C	T.C / Supercut
115 mm – 4 ½ "	01-1394	01-1395	01-1396	01-1397

Anatomy scissors



110 mm - 4 ¹ / ₃ "	01-1398	01-1399
--	---------	---------

Dura scissors



TAYLOR

1:2

145 mm – 5 ¾"

01-1400



SCHMIEDEN

1:2

170 mm – 6 ¾"

01-1401



DANDY

1:2

170 mm – 6 ¾"

01-1402



1:2



1:2

STRULLY

220 mm – 8 ¾"

01-1403



1:2

01-1404

Ligature scissors



LITTAUER 1:2

140 mm – 5 ½ "	01-1405
----------------	---------



O'BRIEN 1:2

90 mm – 3 ½ "	01-1406
---------------	---------



BUCK

145 mm – 5 ¾ "	01-1407-01
180 mm – 7 "	01-1407-02



1:2

115 mm – 4 ½ "	01-1408
----------------	---------



SPENCER

90 mm – 3 ½ "	01-1409-01	01-1410
110 mm – 4 ⅓ "	01-1409-02	
130 mm – 5 "	01-1409-03	

laterally curved

Ligature scissors



NORTHBENT

90 mm – 3 ½ "	01-1411-01
125 mm – 5 "	01-1411-02



HEATH 1:2

150 mm – 6 "
01-1412

saw edge



1:2

120 mm – 4 ¾ "
01-1413

saw edge



EISELSBERG 1:2

115 mm – 4 ½ "	01-1414
----------------	---------



90 mm – 3 ½ "	01-1415
---------------	---------

Wire cutting scissors



1:2
UNIVERSAL

	T.C
120 mm – 4 ¾ "	120 mm – 4 ¾ "
01-1416	01-1417

saw edge



1:2

saw edge



HARVEY 1:2

125 mm – 5 "
01-1418

saw edge



SCHUKNECHT 1:2

125 mm – 5 "
01-1419

saw edge



1:2

BEEBEE

105 mm – 4 "	01-1420	01-1421	01-1422	01-1423
---------------------	---------	---------	---------	---------

straight

blunt – blunt

sharp – sharp

blunt – blunt, saw edge

sharp – sharp, saw edge

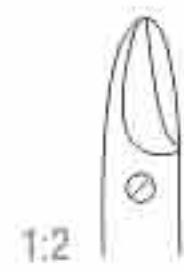

1:2



1:2



1:2

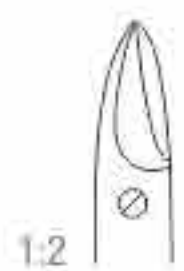

1:2



1:2

BEEBEE

105 mm – 4 "	01-1424	01-1425	01-1426	01-1427
---------------------	---------	---------	---------	---------

curved

blunt – blunt

sharp – sharp

blunt – blunt, saw edge

sharp – sharp, saw edge



1:2



1:2

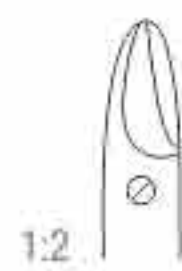

1:2



1:2

Bandage scissors



UNIVERSAL

140 mm – 5 ½ "	01-1428-01
180 mm – 7 "	01-1428-02



LISTER

180 mm – 7 "	01-1429-01
200 mm – 8 "	01-1429-02



LISTER

		Supercut	T.C
90 mm – 3 ½ "	01-1430-01		01-1432-01
110 mm – 4 ¼ "	01-1430-02		01-1432-02
140 mm – 5 ½ "	01-1430-03	01-1431-01	01-1432-03
155 mm – 6 "	01-1430-04		01-1432-04
180 mm – 7 "	01-1430-05	01-1431-02	01-1432-05
200 mm – 8 "	01-1430-06	01-1431-03	01-1432-06

Bandage scissors



LANGE 1:2

180 mm – 7"	01-1433
-------------	---------



KNOWLES 1:2

140 mm – 5 ½"	01-1434
---------------	---------



160 mm – 6 ¼" 01-1435



SMITH (MOD.USA)

160 mm – 6 ¼"	01-1436-01
180 mm – 7"	01-1436-02
200 mm – 8"	01-1436-03
230 mm – 9"	01-1436-04

Bandage scissors – Plaster shears



ESMARCH

200 mm – 8"	01-1437-01
220 mm – 8 ¼"	01-1437-02



EXCENTRIC

160 mm – 6 ¼"	01-1438-01
190 mm – 7 ½"	01-1438-02

saw edge



BERGMANN

230 mm – 9"	01-1439
-------------	---------

1:2



LORENZ

230 mm – 9"	01-1440
-------------	---------

1:2

Plaster shears



1:2



1:2

1:2

1:2

BRUNS

		T.C	
235 mm – 9 ¼"	01-1441	01-1442	01-1443

saw edge



1:2

200 mm – 8"	01-1444
--------------------	---------



1:2

SEUTIN

230 mm – 9"	01-1445
--------------------	---------

Cuticle scissors – Nail scissors



105 mm – 4 ¼ "	01-1446-01	01-1447-01
115 mm – 4 ½ "	01-1446-02	01-1447-02



90 mm – 3 ½ "	01-1448-01	01-1449-01
100 mm – 4 "	01-1448-02	01-1449-02
110 mm – 4 ¼ "	01-1448-03	01-1449-03

Nail splitting scissors



130 mm – 5"	01-1450-01
150 mm – 6"	01-1450-02



SYSTRUNK 1:2	1:2	1:2
130 mm – 5"	01-1451	01-1452

Dressing forceps



STANDARD

		T.C	titan		T.C	titan	
105 mm – 4 ¼ "	01-1455-01	01-1456-01		01-1458-01	01-1459-01		01-1461-01
115 mm – 4 ½ "	01-1455-02	01-1456-02		01-1458-02	01-1459-02		01-1461-02
130 mm – 5 "	01-1455-03	01-1456-03		01-1458-03	01-1459-03		01-1461-03
145 mm – 5 ¾ "	01-1455-04	01-1456-04	01-1457-01	01-1458-04	01-1459-04		01-1461-04
150 mm – 6 "	01-1455-05	01-1456-05		01-1458-05	01-1459-05		01-1461-05
160 mm – 6 ½ "	01-1455-06	01-1456-06		01-1458-06	01-1459-06		01-1461-06
180 mm – 7 "	01-1455-07	01-1456-07	01-1457-02	01-1458-07	01-1459-07	01-1460	01-1461-07
200 mm – 8 "	01-1455-08	01-1456-08		01-1458-08	01-1459-08		01-1461-08
230 mm – 9 "	01-1455-09	01-1456-09		01-1458-09	01-1459-09		
250 mm – 10 "	01-1455-10	01-1456-10	01-1457-03	01-1458-10	01-1459-10		01-1461-09
300 mm – 12 "	01-1455-11	01-1456-11		01-1458-11	01-1459-11		01-1461-10
350 mm – 14 "	01-1455-12	01-1456-12			01-1459-12		
400 mm – 15 ¾ "	01-1455-13	01-1456-13			01-1459-13		

narrow

narrow

narrow

curved

Dressing forceps



130 mm – 5 "	01-1462-01
145 mm – 5 ¼ "	01-1462-02
160 mm – 6 ¼ "	01-1462-03
180 mm – 7 "	01-1462-04

cross serated

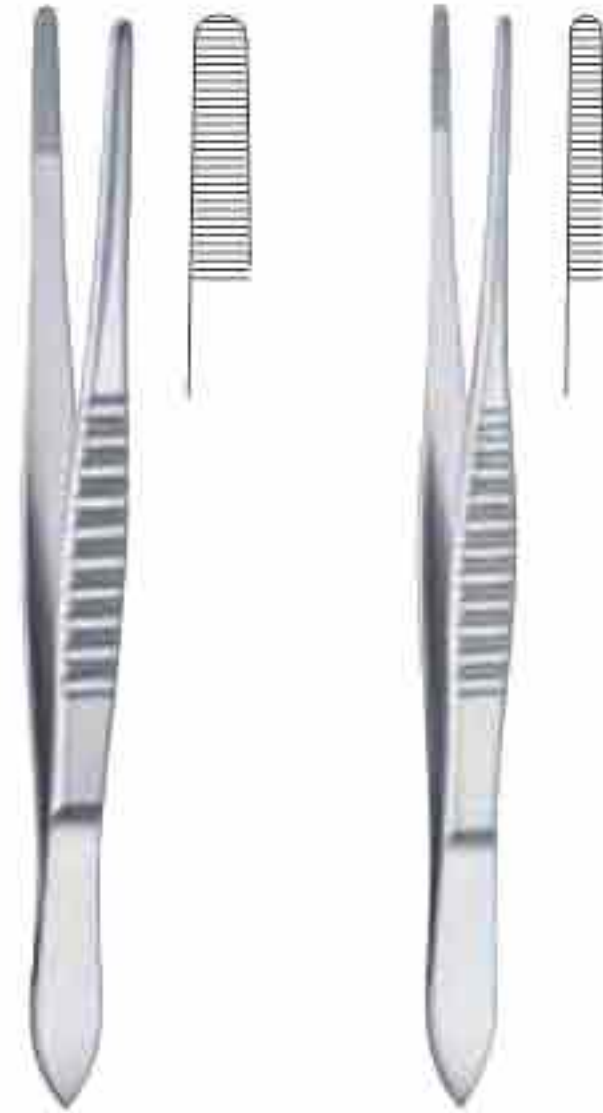

Mod. UsA

120 mm – 4 ¾ "	01-1463-01	01-1464-01
130 mm – 5 "	01-1463-02	01-1464-02
145 mm – 5 ¾ "	01-1463-03	01-1464-03
155 mm – 6 "	01-1463-04	01-1464-04
180 mm – 7 "	01-1463-05	01-1464-05
210 mm – 8 ¼ "	01-1463-06	01-1464-06
250 mm – 9 ¾ "	01-1463-07	01-1464-07
310 mm – 12 ¼ "	01-1463-08	01-1464-08

narrow

Dressing forceps



stille

115 mm – 4 ½ "	01-1465-01
130 mm – 5 "	01-1465-02
150 mm – 6 "	01-1465-03
170 mm – 6 ⅔ "	01-1465-04
200 mm – 8 "	01-1465-05
250 mm – 9 ¾ "	01-1465-06



seMken

		almedur	titan
125 mm – 5 "	01-1466-01	01-1467-01	01-1468
155 mm – 6 "	01-1466-02	01-1467-02	

Dressing forceps

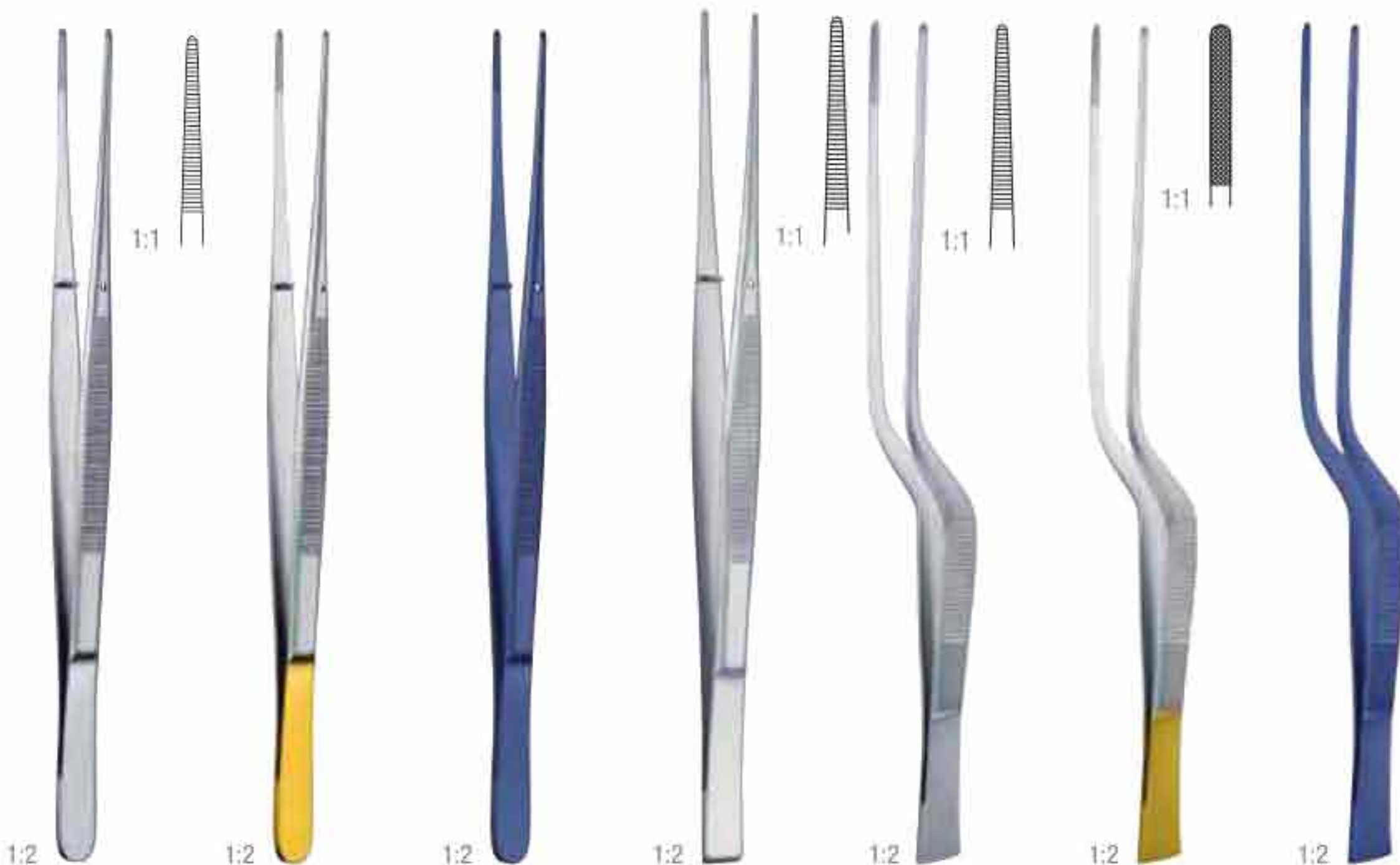

Taylor

		T.C	titan			T.C	titan
175 mm – 7"	01-1469	01-1470	01-1471	01-1472	01-1473	01-1474	01-1475

Dressing forceps



GERALD

		T.C	titan		
145 mm – 3 ¾ "		01-1477-01			01-1480-01
180 mm – 7 "	01-1476-01	01-1477-02	01-1478	01-1479-01	01-1480-02
190 mm – 7 ½ "		01-1477-03			01-1480-03
230 mm – 9 "	01-1476-02	01-1477-04		01-1479-02	
250 mm – 10 "	01-1476-03	01-1477-05		01-1479-03	

Dressing forceps



Adson

		light weight	T.C	titan
120 mm – 4 3/4 "	01-1481-01	01-1482	01-1483-01	01-1484
150 mm – 6 "	01-1481-02		01-1483-02	



Hudson (EWAlD)

120 mm – 4 3/4 "
01-1485



Micro-Adson

		light weight	T.C
120 mm – 4 3/4 "	01-1486-01	01-1487	01-1488-01
150 mm – 6 "	01-1486-02		01-1488-02



Adson 1:2

120 mm – 4 3/4 "
01-1489

cross serrated

Dressing forceps



CUSHING

		T.C		T.C
175 mm – 7"	01-1490	01-1491	01-1492	01-1493

DUEHRSEN

	1:2
200 mm – 8"	01-1494



BROPHY

	1:2	1:2
200 mm – 8"	01-1495	01-1496

MCINDOE

		T.C	titan
150 mm – 6"	01-1497	01-1498	01-1499

Dressing forceps

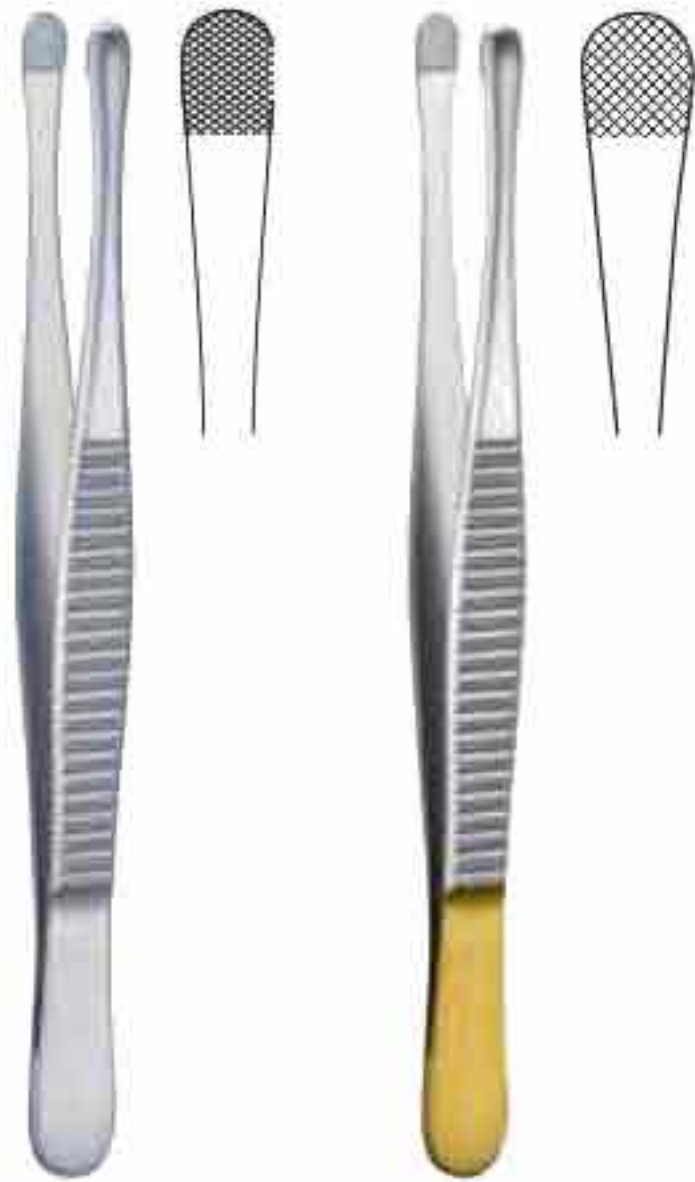

wAnGensteen

		T.C
150 mm – 6"	01-1500-01	01-1501-01
230 mm – 9"	01-1500-02	01-1501-02
250 mm – 9 ¼"		01-1501-03
300 mm – 12"	01-1500-03	01-1501-04



wAUGH

150 mm – 6"	01-1502-01
180 mm – 7"	01-1502-02
200 mm – 8"	01-1502-03
250 mm – 9 ¼"	01-1502-04



Potts-sMith

		T.C	titan	
150 mm – 6"		01-1504-01		
180 mm – 7"	01-1503-01	01-1504-02	01-1505-01	01-1506-01
210 mm – 8 ¼"	01-1503-02	01-1504-03	01-1505-02	01-1506-02
230 mm – 9"	01-1503-03	01-1504-04		01-1506-03
250 mm – 9 ¼"	01-1503-04	01-1504-05	01-1505-03	01-1506-04
300 mm – 12"	01-1503-05	01-1504-06		01-1506-05

Tissue forceps

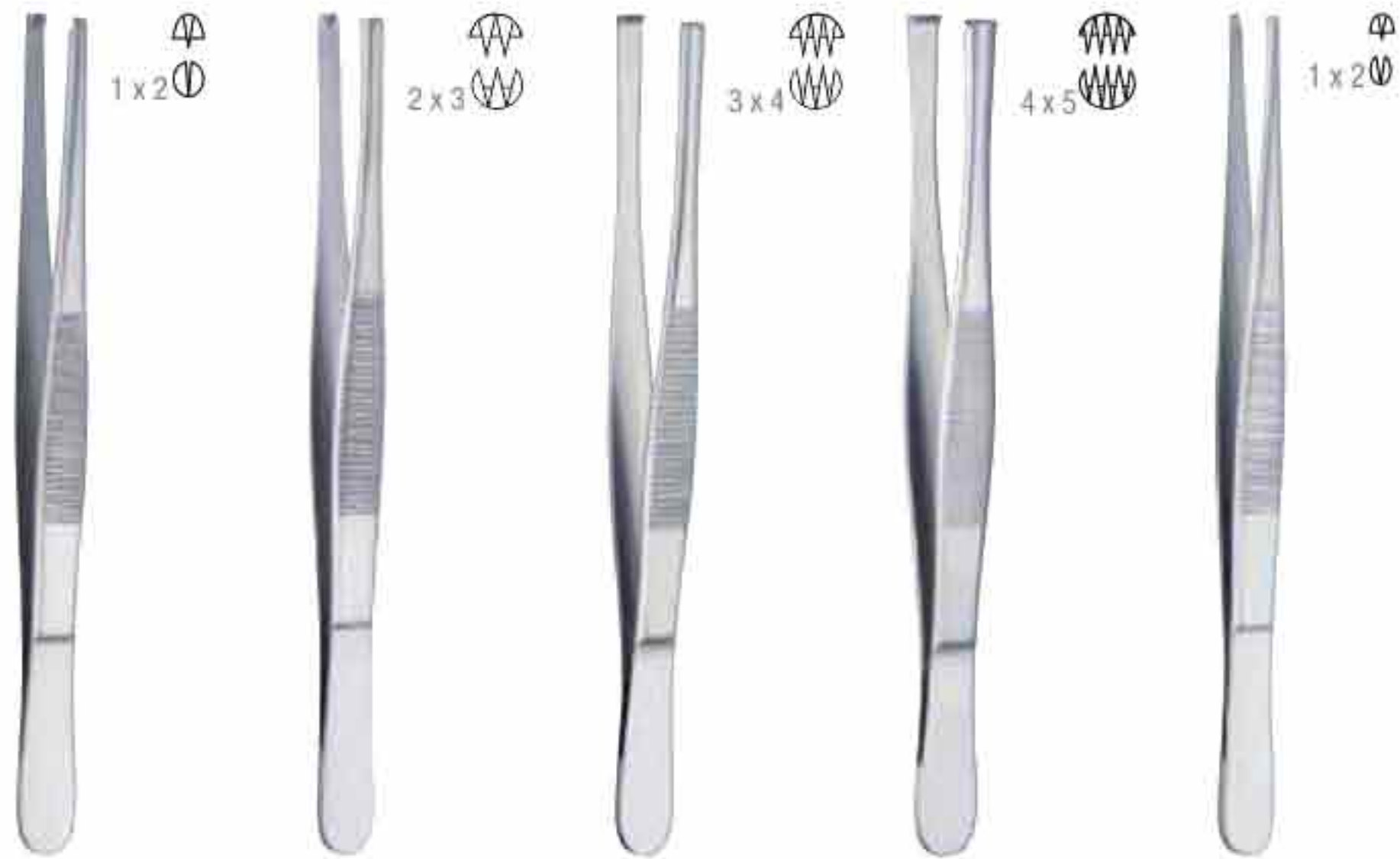

STANDARD

105 mm – 4 ¼ "	01-1507-01	01-1508-01			01-1511-01
115 mm – 4 ½ "	01-1507-02	01-1508-02			01-1511-02
130 mm – 5 "	01-1507-03	01-1508-03	01-1509-01	01-1510-01	01-1511-03
145 mm – 5 ¾ "	01-1507-04	01-1508-04	01-1509-02	01-1510-02	01-1511-04
150 mm – 6 "	01-1507-05	01-1508-05			01-1511-05
160 mm – 6 ¼ "	01-1507-06	01-1508-06	01-1509-03	01-1510-03	01-1511-06
180 mm – 7 "	01-1507-07	01-1508-07		01-1510-04	01-1511-07
200 mm – 8 "	01-1507-08	01-1508-08	01-1509-04		01-1511-08
250 mm – 9 ¾ "	01-1507-09	01-1508-09	01-1509-05	01-1510-05	01-1511-09
300 mm – 12 "	01-1507-10	01-1508-10	01-1509-06		01-1511-10
350 mm – 14 "	01-1507-11				
400 mm – 15 ¾ "	01-1507-12				

narrow

Tissue forceps

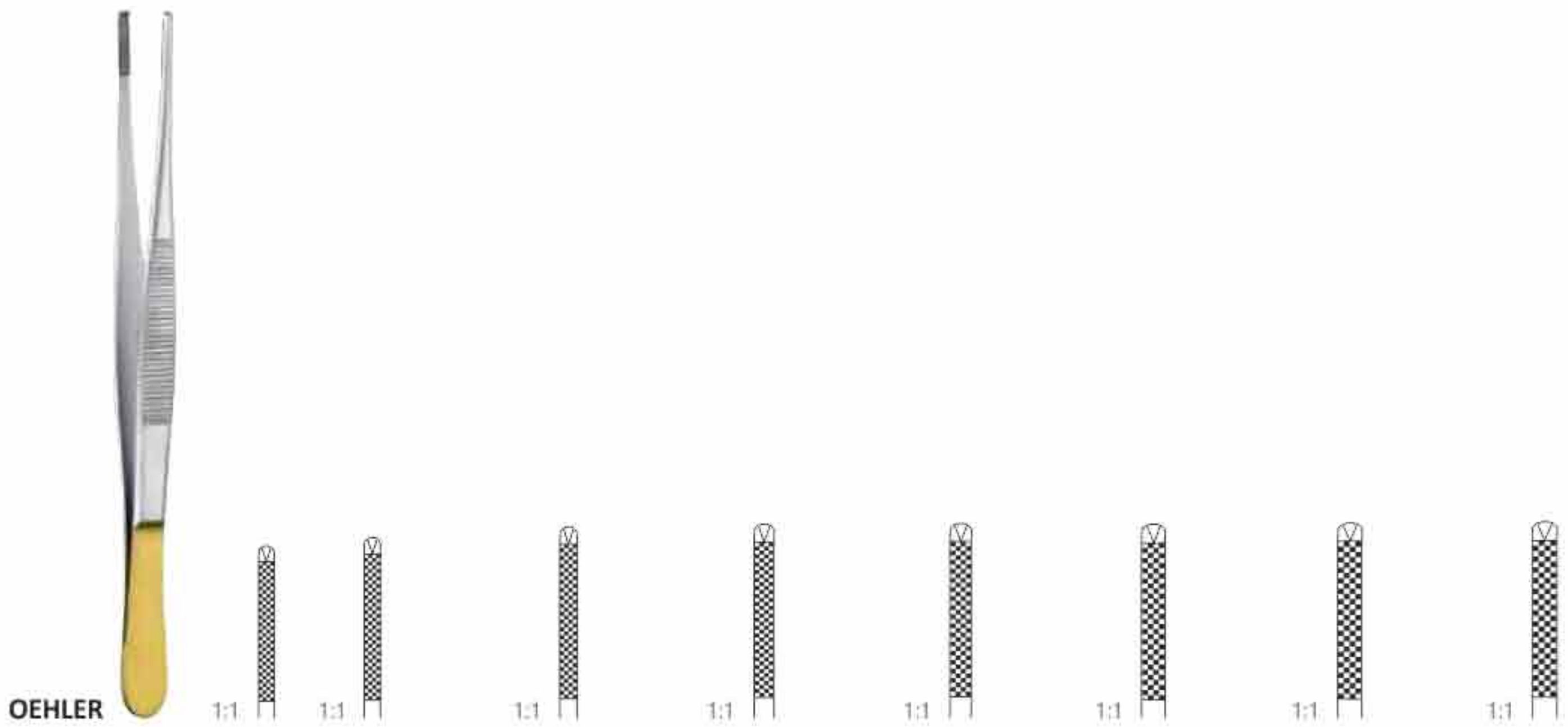

T.C	T.C	T.C	T.C	T.C	T.C	T.C	T.C
115 mm – 4 ½ "	130 mm – 5 "	140 mm – 5 ½ "	160 mm – 6 "	180 mm – 7 "	200 mm – 8 "	250 mm – 9 ¾ "	300 mm – 12 "
01-1512	01-1513	01-1514	01-1515	01-1516	01-1517	01-1518	01-1519

Tissue forceps



stille

130 mm – 5"	01-1520-01	
150 mm – 6"	01-1520-02	01-1521-01
170 mm – 6 3/4"	01-1520-03	01-1521-02
200 mm – 8"	01-1520-04	



Mod. Usa

120 mm – 4 3/4"	01-1522-01
130 mm – 5"	01-1522-02
145 mm – 5 3/4"	01-1522-03
155 mm – 6"	01-1522-04
185 mm – 7"	01-1522-05
210 mm – 8"	01-1522-06
250 mm – 9 3/4"	01-1522-07
310 mm – 12 1/4"	01-1522-08

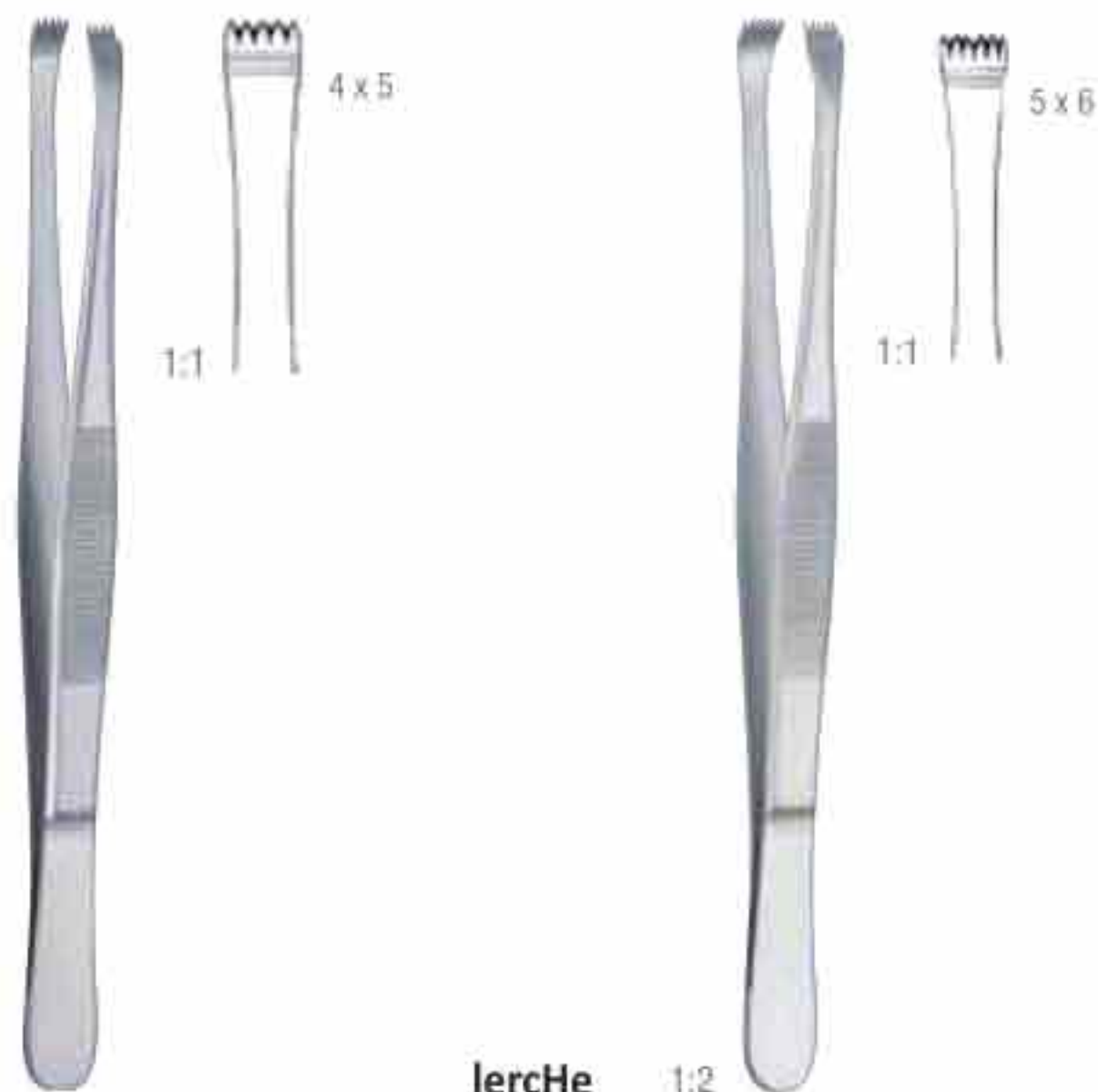

stone 1:2

150 mm – 6"
01-1523

lercHe 1:2

150 mm – 6"
01-1524



AdlerkreUtz

130 mm – 5"		01-1526-01
145 mm – 5 3/4"	01-1525-01	01-1526-02
150 mm – 6"	01-1525-02	01-1526-03
180 mm – 7"		01-1526-04
200 mm – 8"	01-1525-03	01-1526-05
250 mm – 9 3/4"	01-1525-04	01-1526-06
300 mm – 12"	01-1525-05	

Tissue forceps

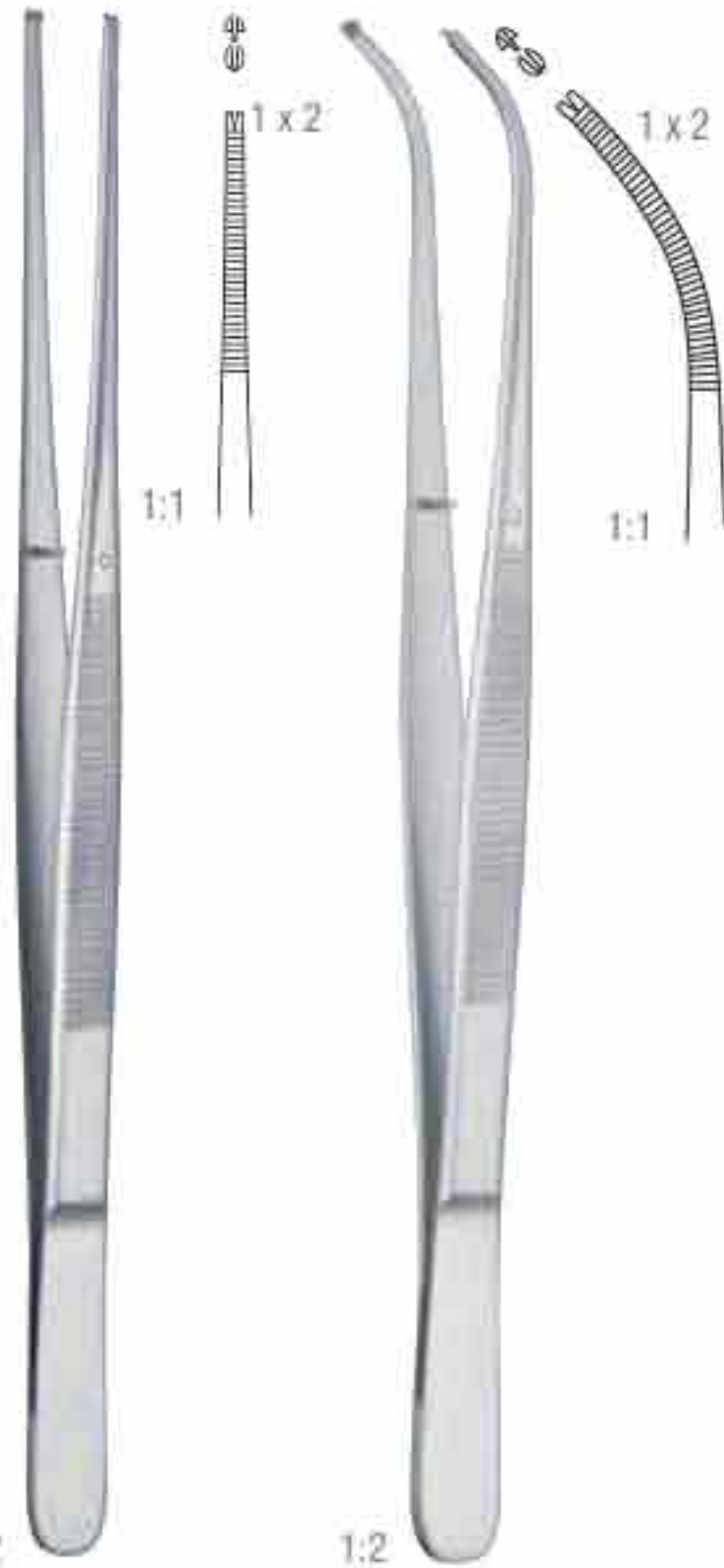

BroPHY

200 mm – 8"	01-1526	01-1527
-------------	---------	---------



Potts-sMitH

180 mm – 7"	01-1528-01	01-1529-01
210 mm – 8 1/4"	01-1528-02	01-1529-02
250 mm – 9 1/4"	01-1528-03	01-1529-03
300 mm – 12"	01-1528-04	01-1529-04
350 mm – 14"	01-1528-05	



**Hudson
(ewAld)**

120 mm – 4"	01-1530
-------------	---------

Tissue forceps

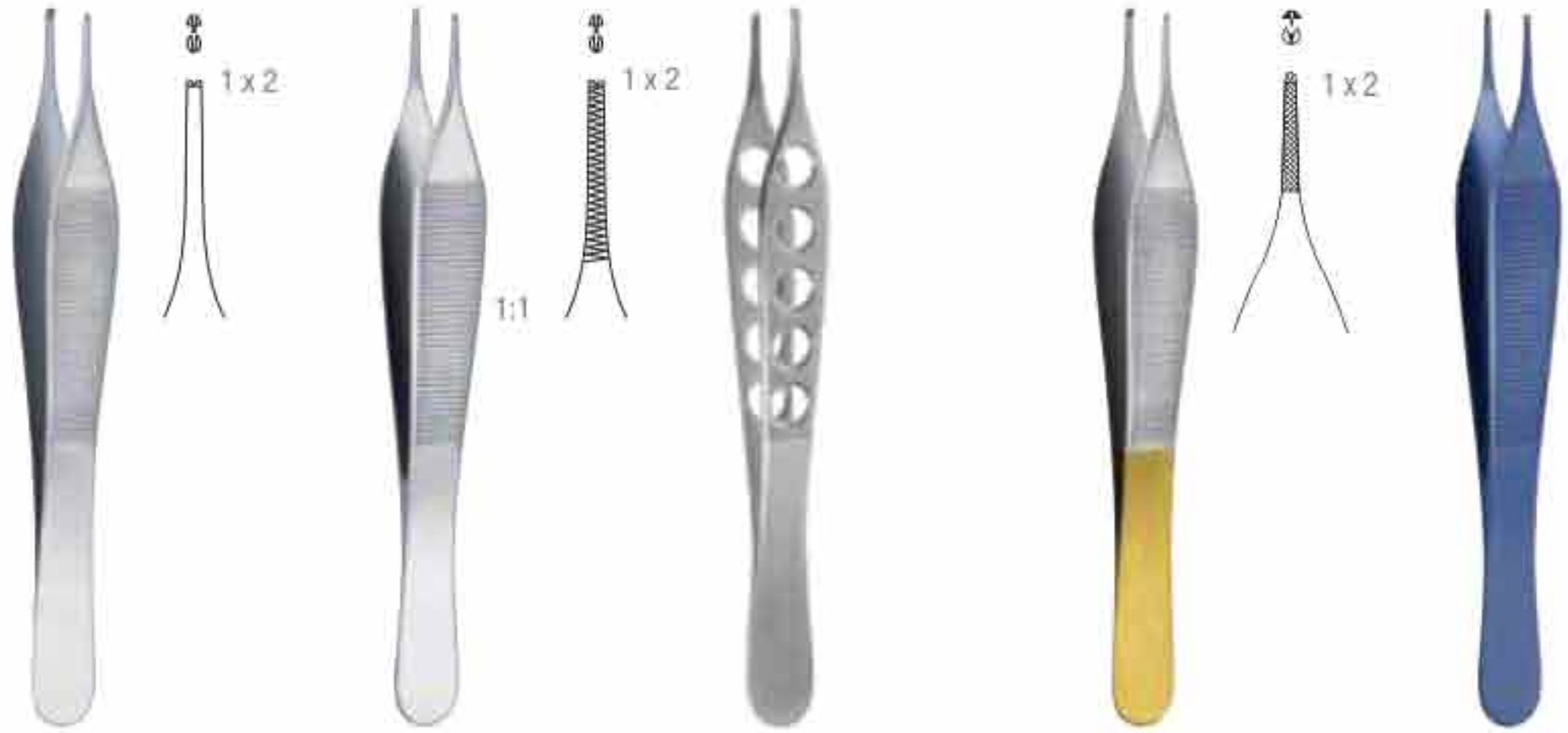

Adson

			light weight	T.C	titan
120 mm – 4 ¼ "	01-1532-01	01-1533	01-1534	01-1535-01	01-1536
150 mm – 6 "	01-1532-02			01-1535-02	

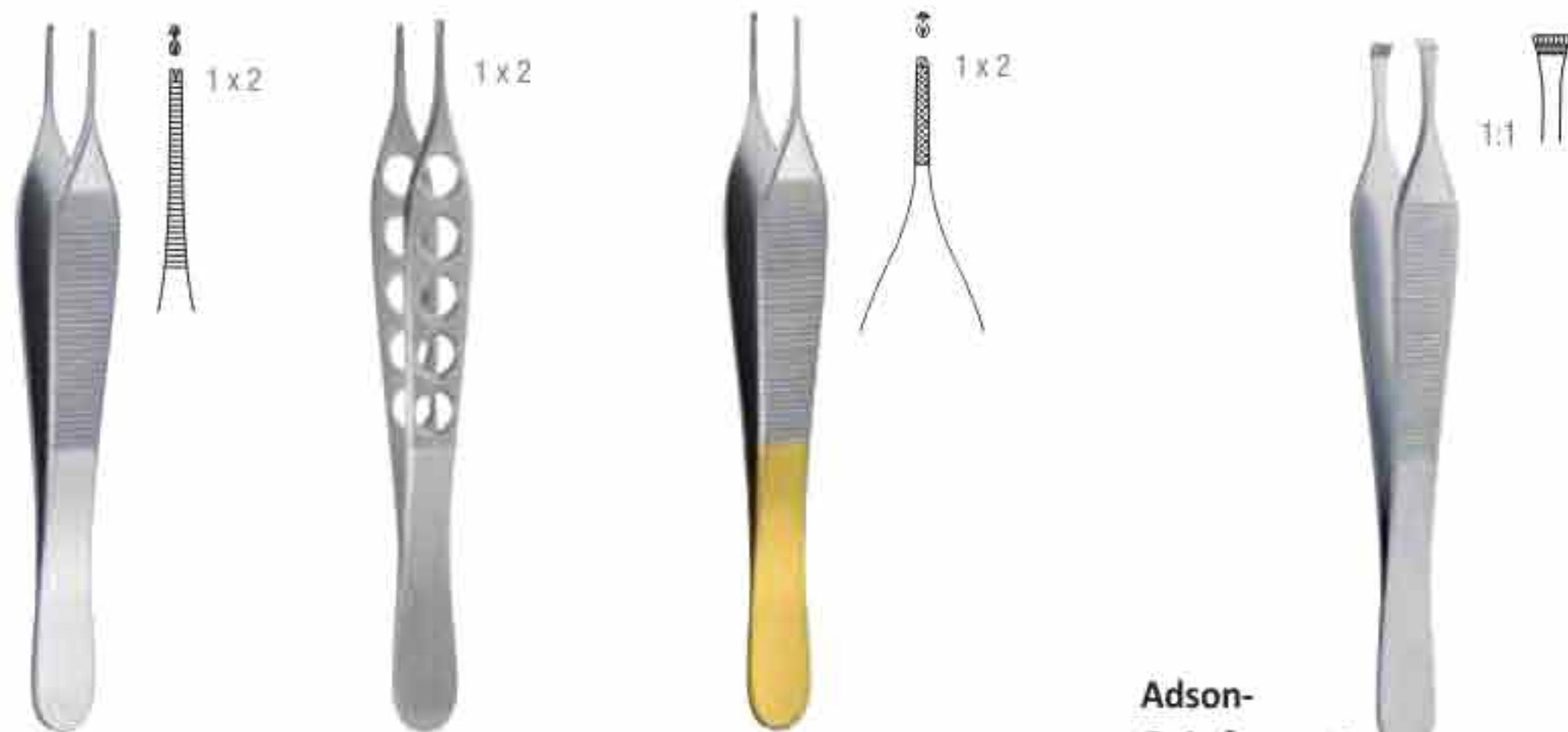

Adson-Micro

		light weight	T.C
120 mm – 4 ¼ "	01-1537-01	01-1538	01-1539-01
150 mm – 6 "	01-1537-02		01-1539-02

Adson-GrAefe

120 mm – 4 ¼ "	01-1540
----------------	---------

Tissue forceps



Adson-Brown

		light weight	T.C	titan	
120 mm – 4 ¾ "	01-1541-01	01-1542	01-1543-01	01-1544	01-1545-01
150 mm – 6 "	01-1541-02		01-1543-02		01-1545-02

Tissue forceps

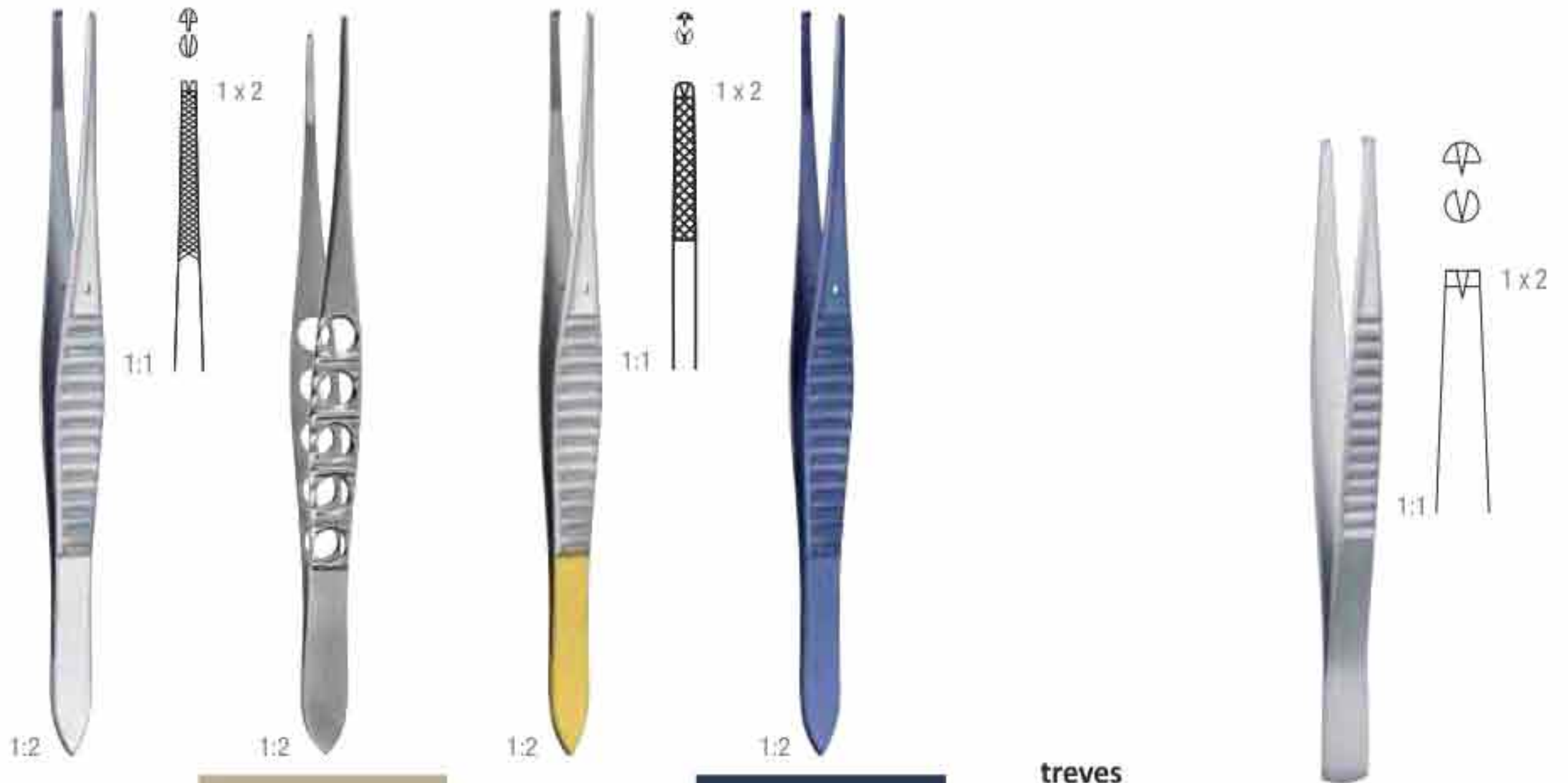

Gillies

		light weight	T.C	titan
150 mm – 6"	01-1546	01-1547	01-1548	01-1549

treves

125 mm – 5"	01-1550
-------------	---------



seMken

125 mm – 5"	01-1551-01
150 mm – 6"	01-1551-02

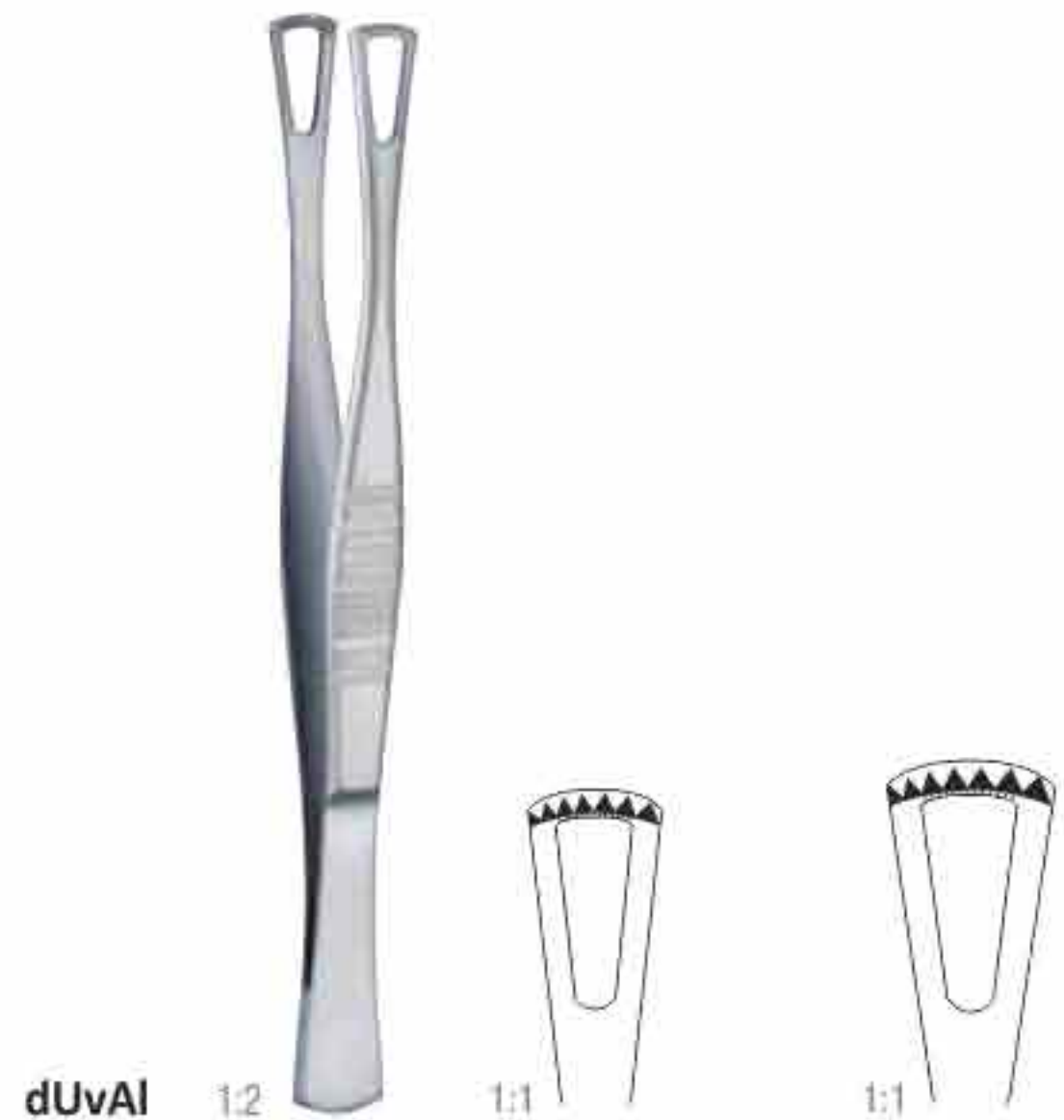

dUvAl 1:2

145 mm – 5 3/4"	01-1552	145 mm – 5 3/4"	01-1553
-----------------	---------	-----------------	---------

Tissue forceps

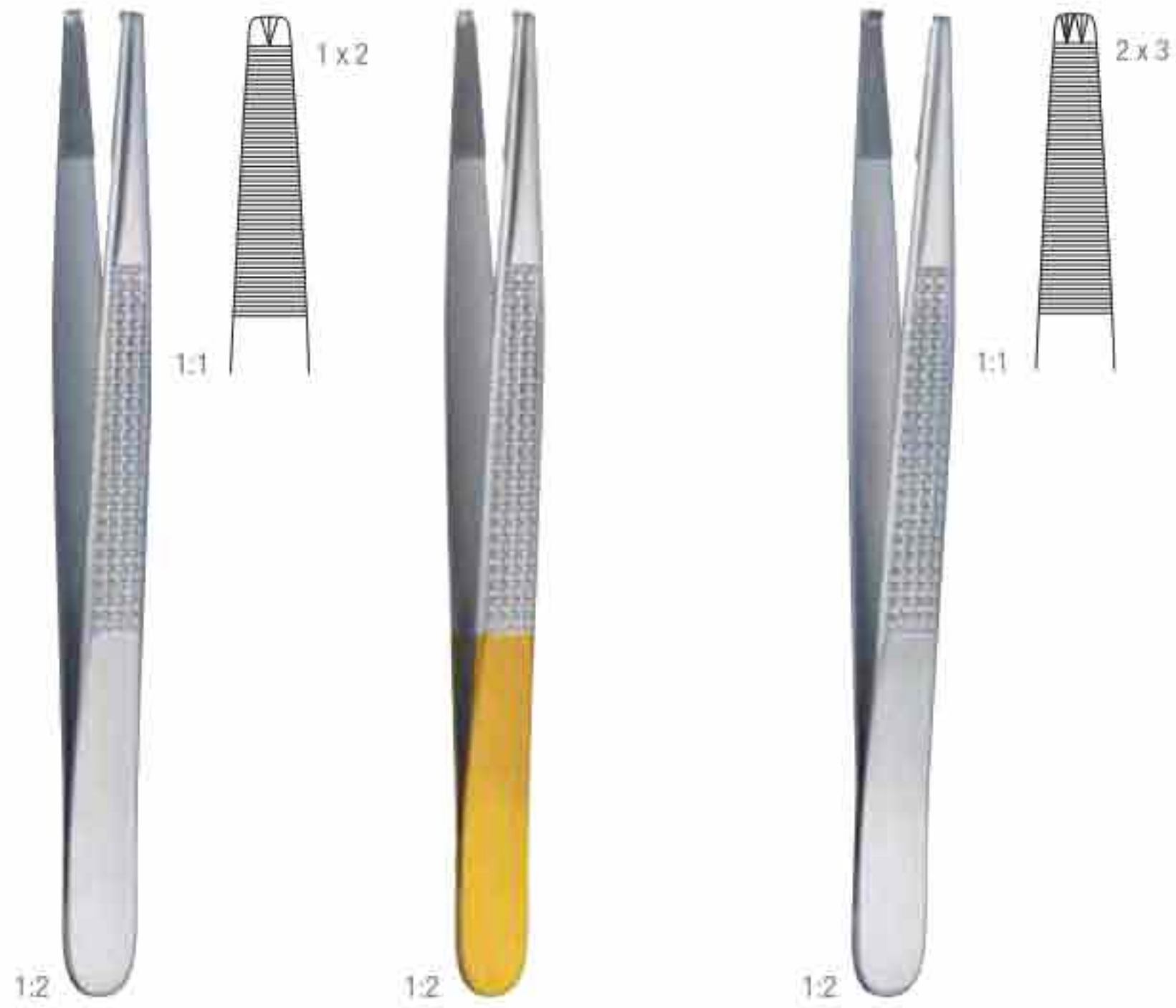

Bonney

		T.C	
175 mm – 7"	01-1554	01-1555	01-1556

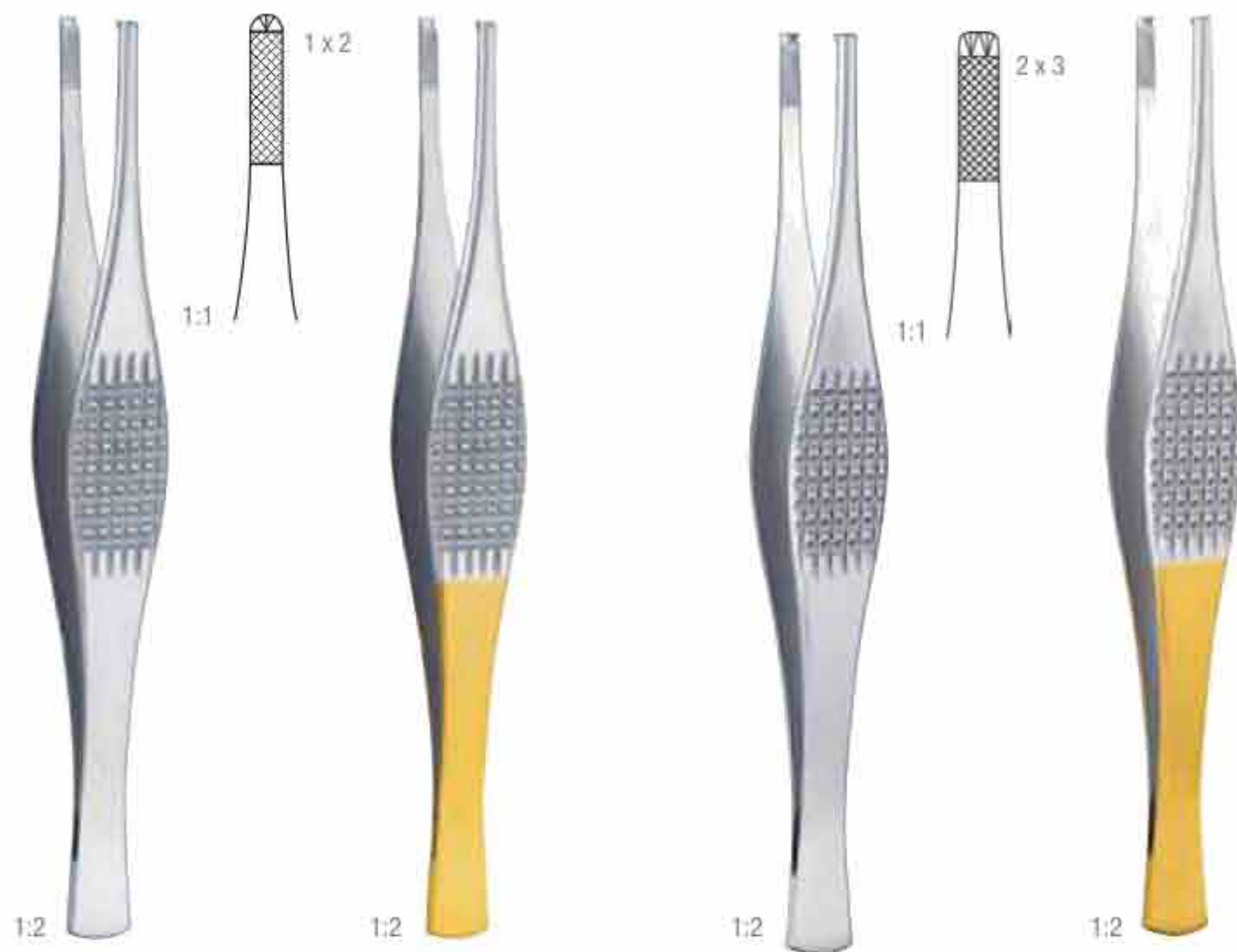

ferris-sMitH

		T.C		T.C
180 mm – 7"	01-1557	01-1558	01-1559	01-1560

Tissue forceps

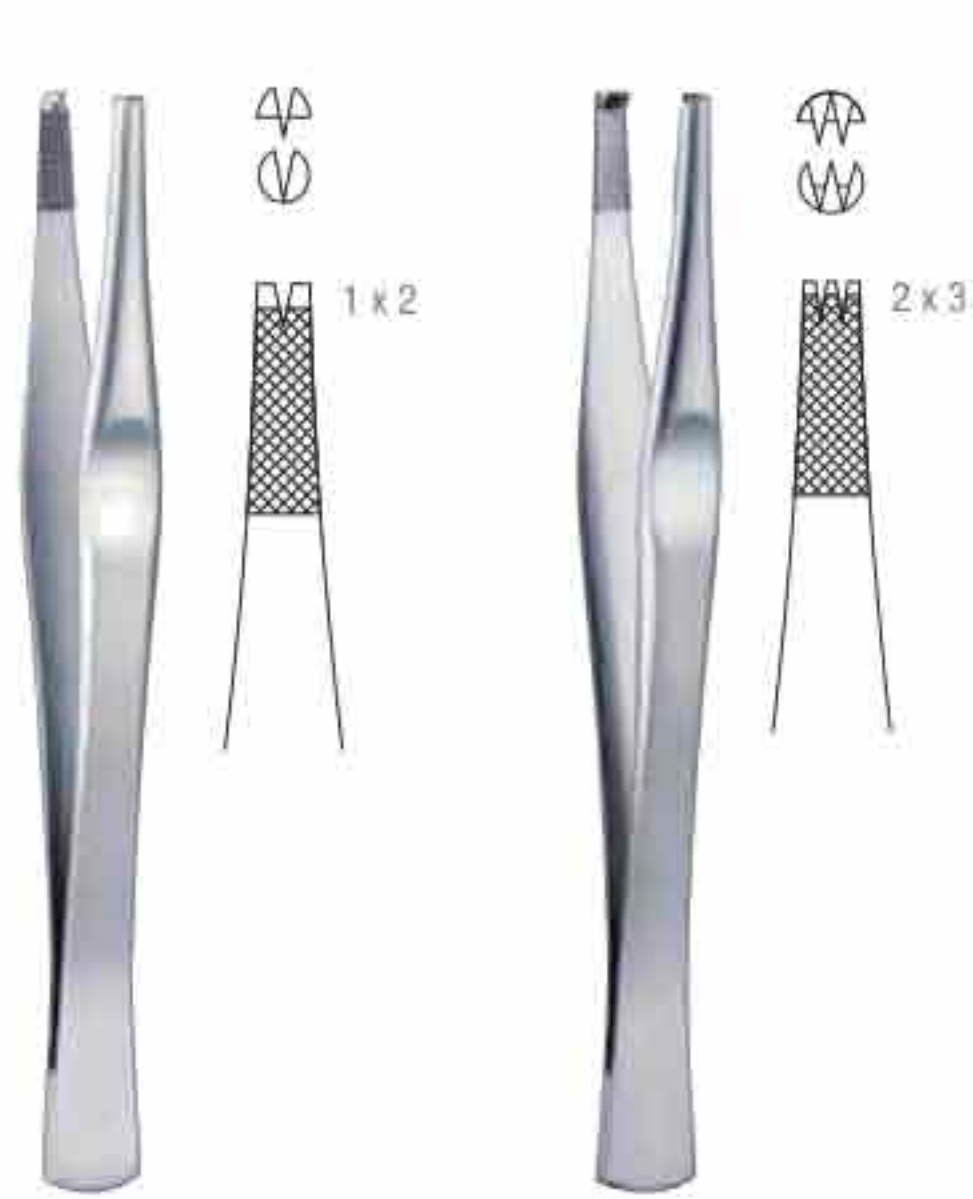

Iane

145 mm – 5 ½ "	01-1561-01	01-1562-01
180 mm – 7 "	01-1561-02	01-1562-02
200 mm – 8 "	01-1561-03	01-1562-03

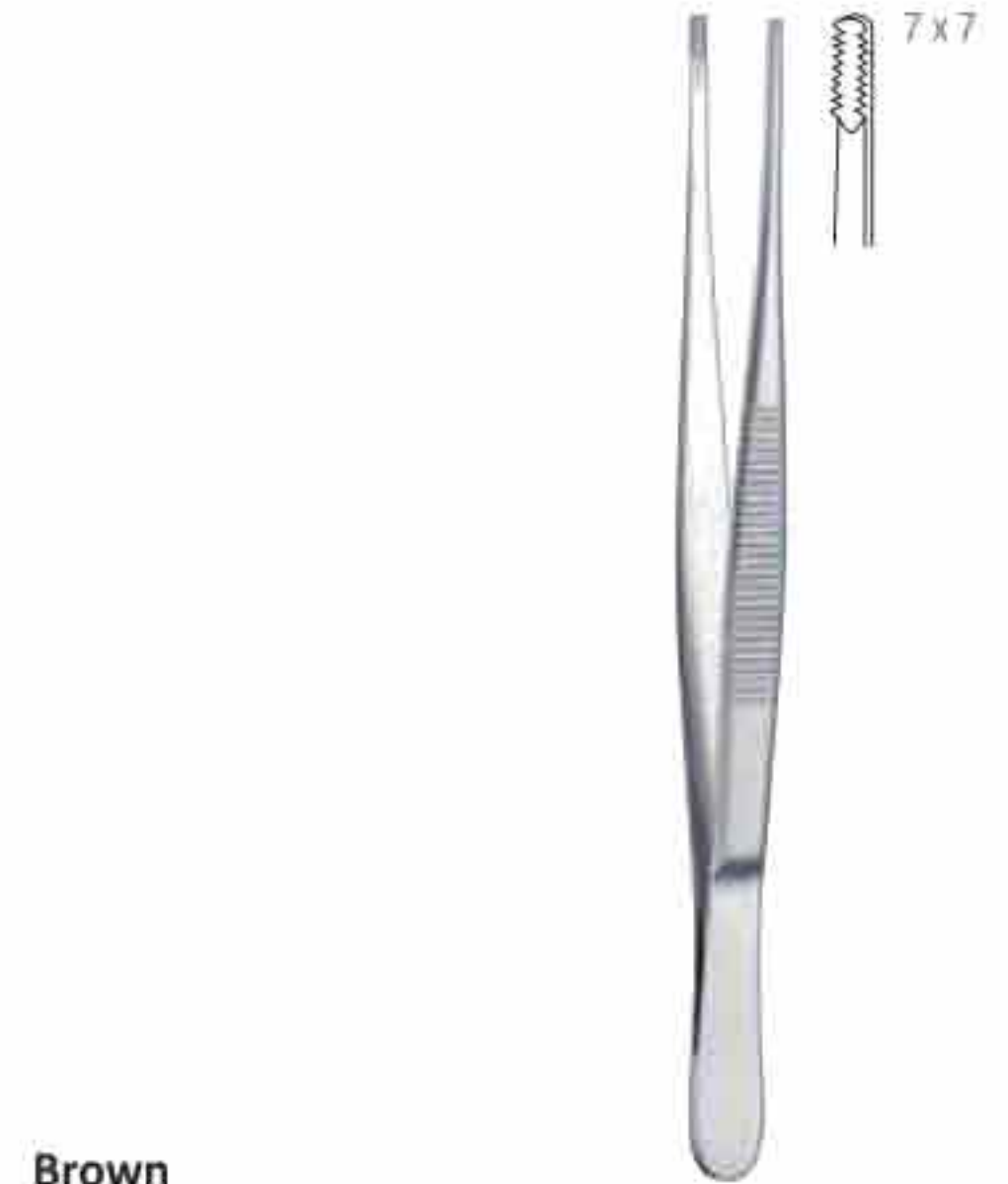

Brown

150 mm – 6 "	01-1563-01
200 mm – 8 "	01-1563-02
250 mm – 9 ¼ "	01-1563-03



denis
Browne

190 mm – 7 ½ "	01-1564
----------------	---------



wAUGH

150 mm – 6 "	01-1565-01
180 mm – 7 "	01-1565-02
200 mm – 8 "	01-1565-03
250 mm – 9 ¼ "	01-1565-04
300 mm – 12 "	01-1565-05

Tissue forceps



stille-BArrAyA

145 mm – 5 ½ "	01-1566-01
160 mm – 6 ¼ "	01-1566-02
180 mm – 7 "	01-1566-03
200 mm – 8 "	01-1566-04
250 mm – 9 ¾ "	01-1566-05

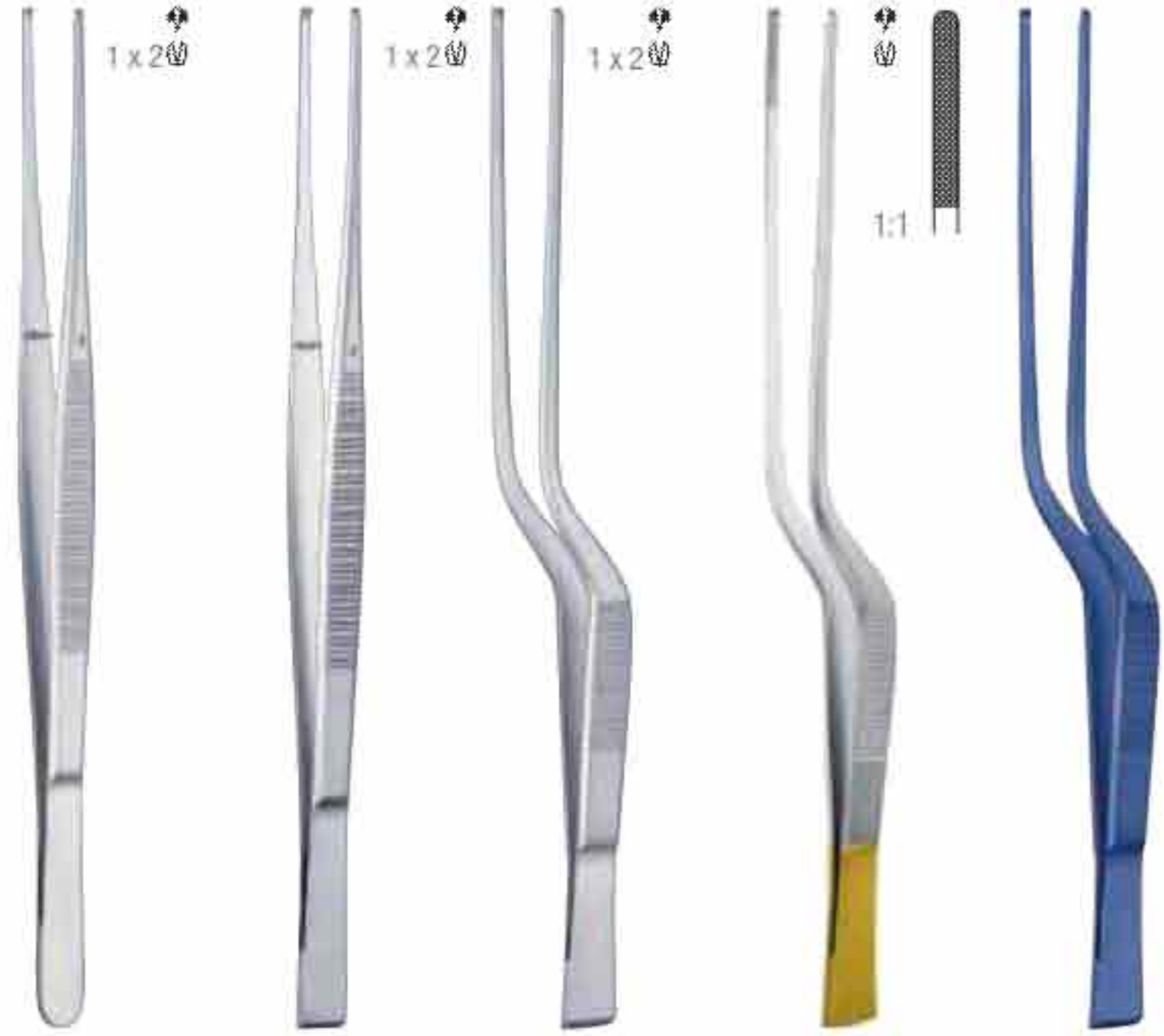

tAylor

				T.C	titan
175 mm – 7 "	01-1567	01-1568	01-1569	01-1570-01	01-1571
180 mm – 7 "				01-1570-02	

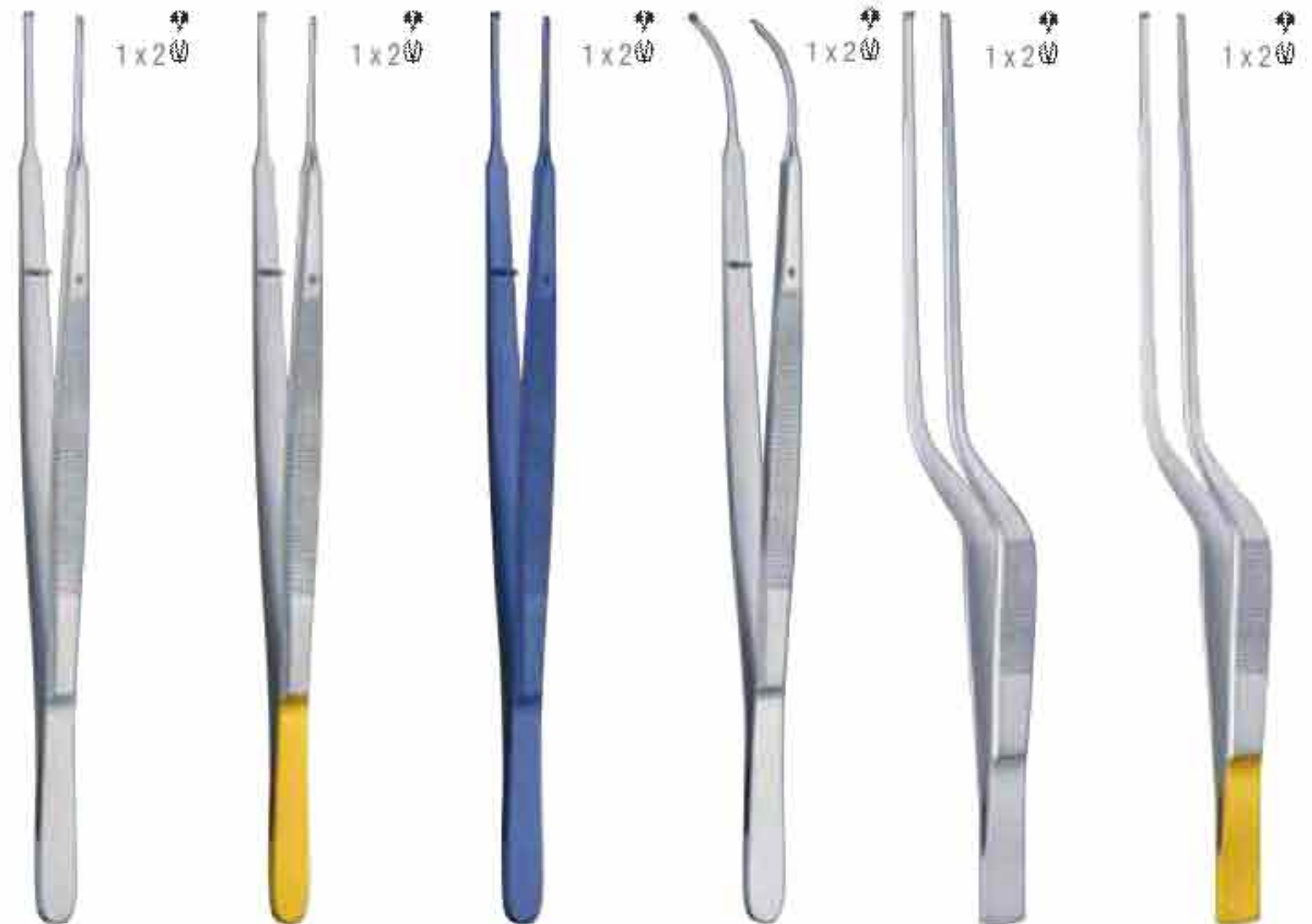

GerAld

		T.C	titan			T.C
170 mm – 6 ¾ "	01-1572-01	01-1573-01	01-1574	01-1575		01-1577-01
180 mm – 7 "		01-1573-02			01-1576	01-1577-02
230 mm – 5 "	01-1572-02	01-1573-03				01-1577-03

Tissue forceps

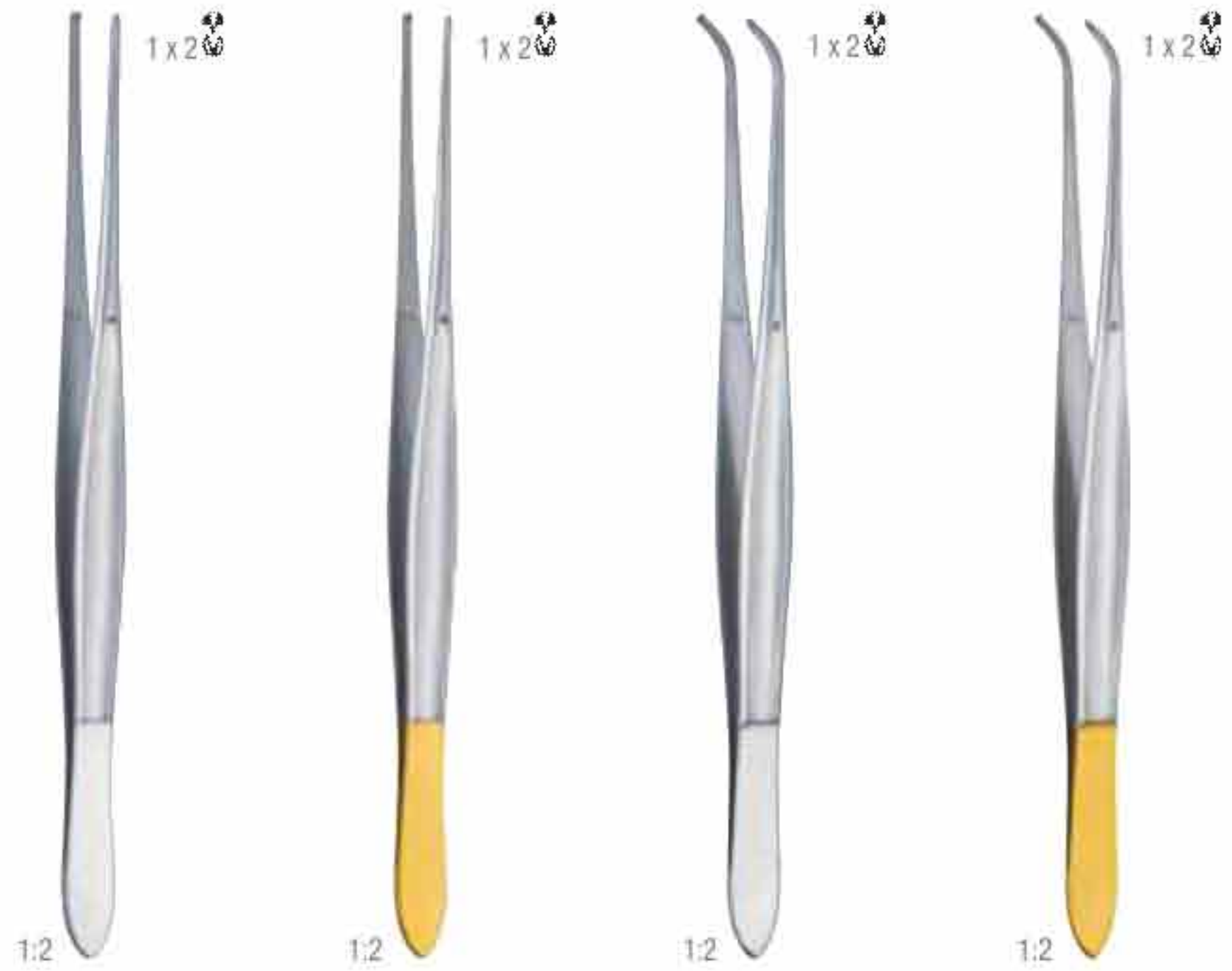

CUSHING

		T.C		T.C
170 mm – 6 ¾ "	01-1578	01-1579	01-1580	01-1581

Ear and nose dressing forceps



troeltsch

150 mm – 6"	01-1582-01	01-1583-01
180 mm – 7"	01-1582-02	01-1583-02



troeltsch (wilde)

110 mm – 4 ¼"	01-1584-01		01-1586-01
120 mm – 4 ¾"	01-1584-02	01-1585	01-1586-02



105 mm – 4 ¼"

01-1587

cross action

Columella forceps



IUcAe

140 mm – 5 ½"	140 mm – 5 ½"
01-1590	01-1588



JAansen / Grünwald

160 mm – 6 ¼"	01-1589-01
195 mm – 7 ⅔"	01-1589-02
210 mm – 8 ¼"	01-1589-03



JAansen / Grünwald

160 mm – 6 ¼"	01-1590-01
195 mm – 7 ⅔"	01-1590-02
210 mm – 8 ¼"	01-1590-03



cottle

145 mm – 5 ¾"
01-1591

Iris forceps

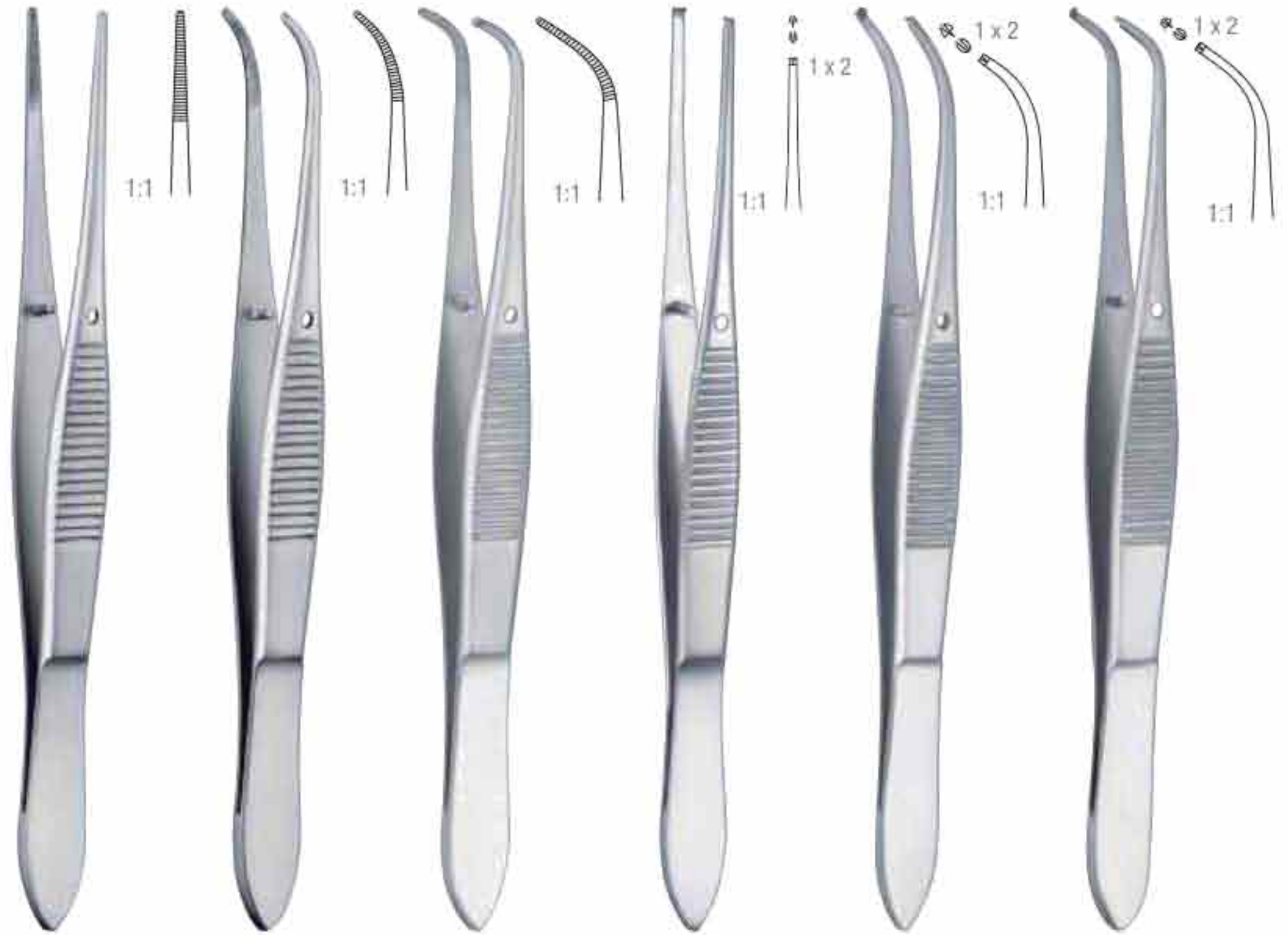

GrAefe

105 mm – 4 ¼ "	0.5 mm	01-1592-01	01-1593-01	01-1594-01	01-1595-01	01-1596-01	01-1597-01
105 mm – 4 ¼ "	0.7 mm	01-1592-02	01-1593-02	01-1594-02	01-1595-02	01-1596-02	01-1597-02
105 mm – 4 ¼ "	1.5 mm	01-1592-03	01-1593-03	01-1594-03	01-1595-03	01-1596-03	01-1597-03

tip

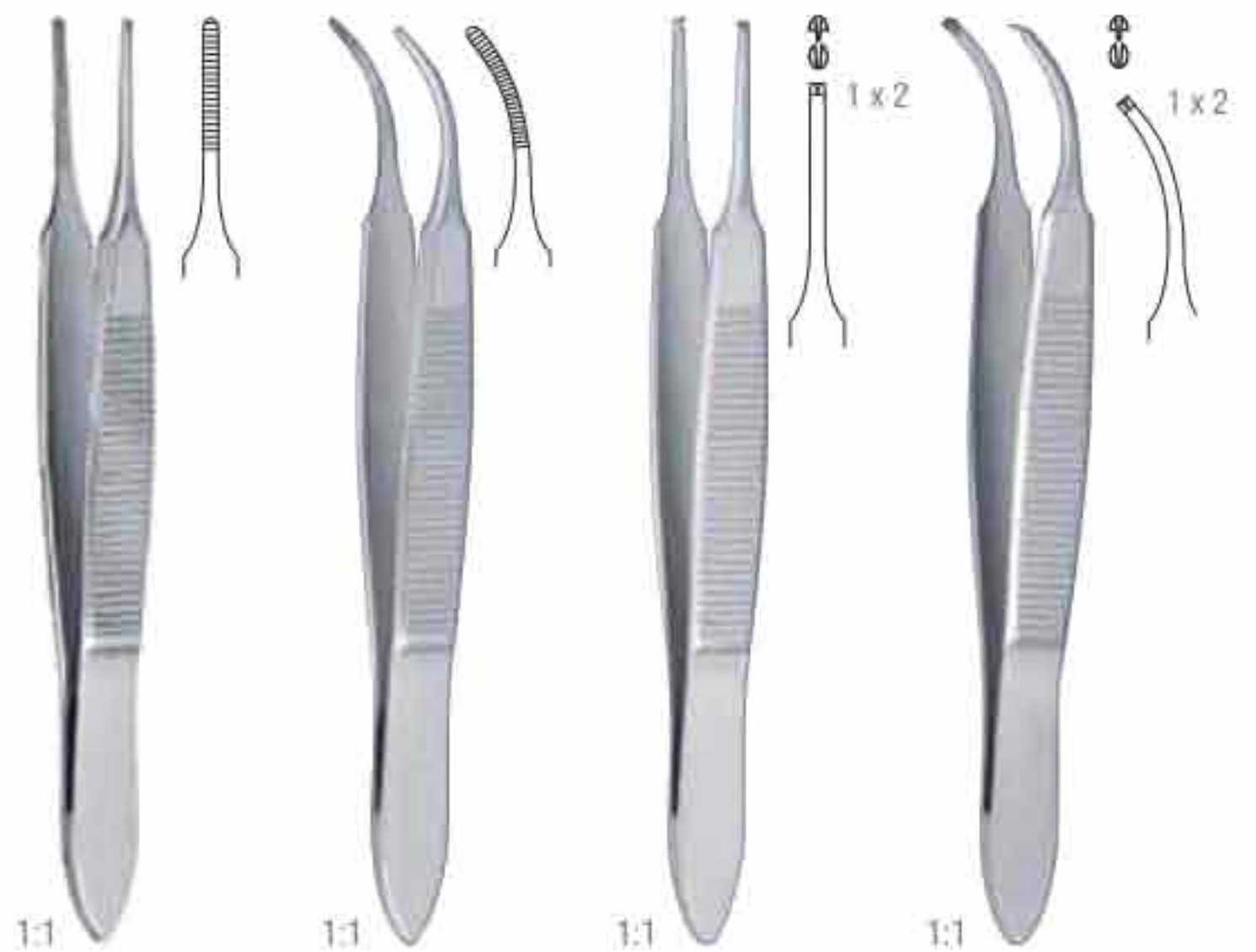

GrAefe

	70 mm – 2 ¾ "	70 mm – 2 ¾ "	70 mm – 2 ¾ "	70 mm – 2 ¾ "
0.5 mm	01-1598-01	01-1599-01	01-1600-01	01-1601-01
0.7 mm	01-1598-02	01-1599-02	01-1600-02	01-1601-02
1.0 mm	01-1598-03	01-1599-03	01-1600-03	01-1601-03

Forceps – fine patterns

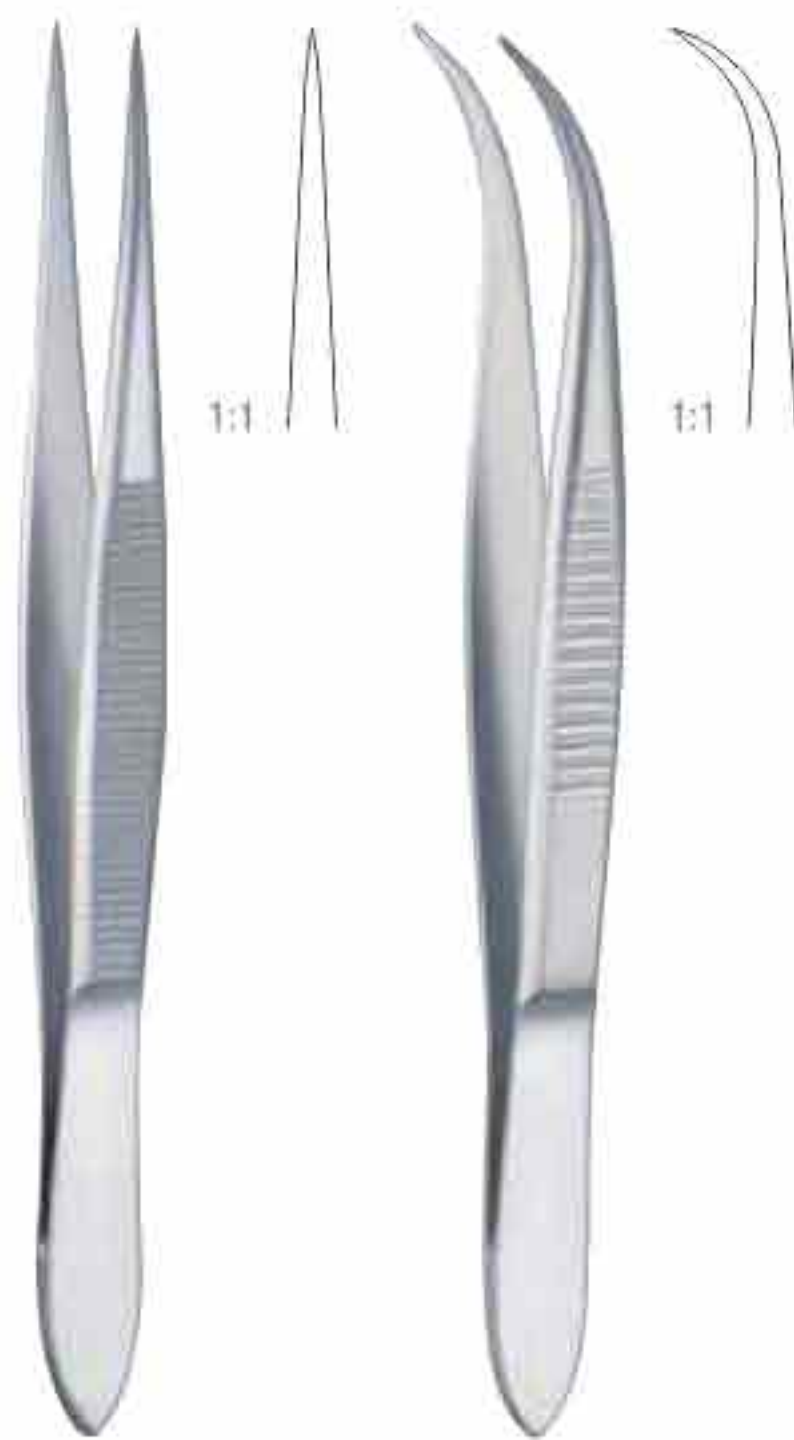

80 mm – 3 "	01-1602-01	01-1603-01
90 mm – 3 ½ "	01-1602-02	01-1603-02
105 mm – 4 ¼ "	01-1602-03	01-1603-03
115 mm – 4 ½ "	01-1602-04	01-1603-04
130 mm – 5 "	01-1602-05	01-1603-05
145 mm – 5²/₃ "	01-1602-06	01-1603-06

smooth

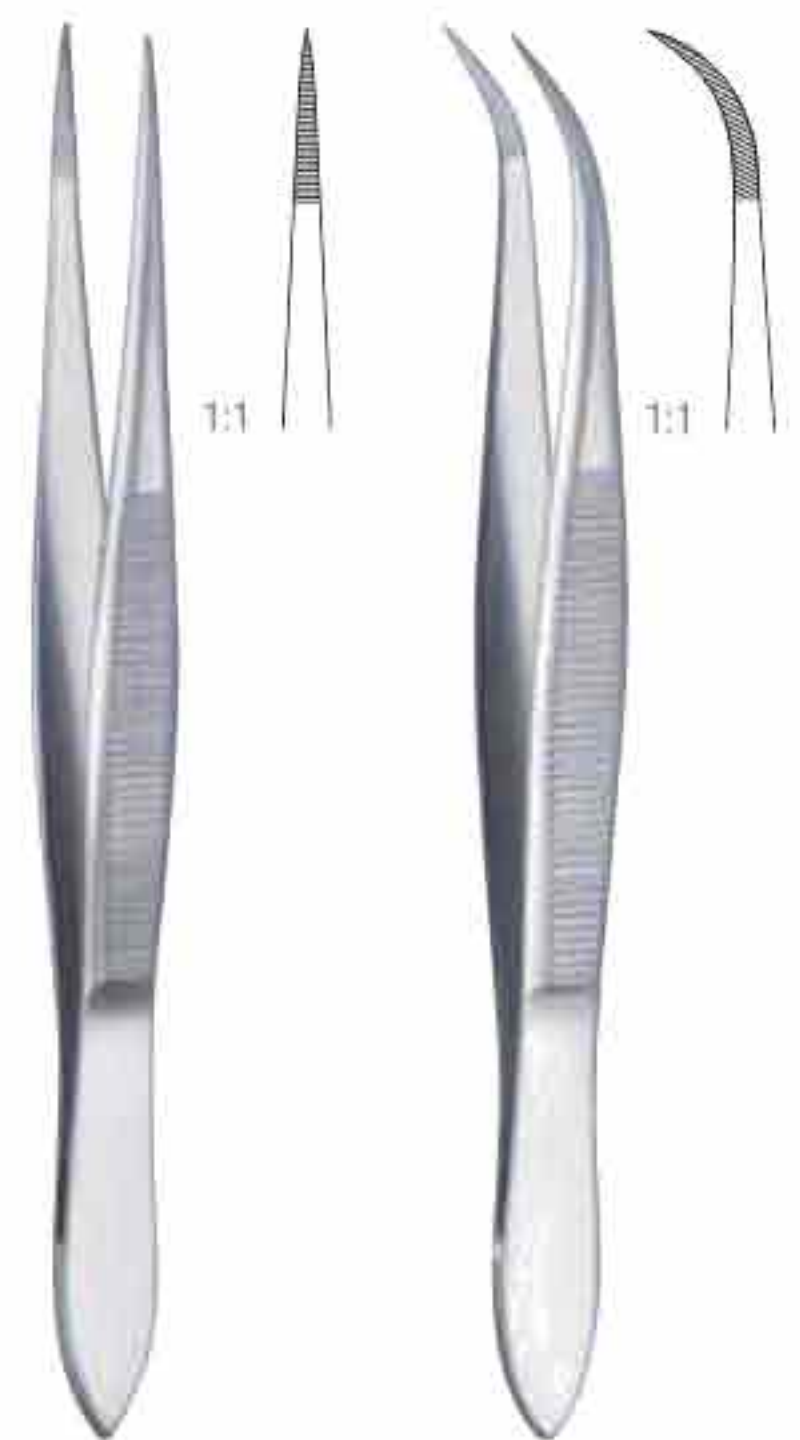

80 mm – 3 "	01-1604-01	01-1605-01
90 mm – 3 ½ "	01-1604-02	01-1605-02
105 mm – 4 ¼ "	01-1604-03	01-1605-03
115 mm – 4 ½ "	01-1604-04	01-1605-04
125 mm – 5 "	01-1604-05	01-1605-05
145 mm – 5²/₃ "	01-1604-06	01-1605-06
160 mm – 6¹/₃ "	01-1604-07	
180 mm – 7 "	01-1604-08	

serrated

Grasping forceps



dUrAnte

145 mm – 5 ¾"	01-1606-01
160 mm – 6 ¼"	01-1606-02
200 mm – 8"	01-1606-03
250 mm – 9 ¾"	01-1606-04



rUss. Modell

150 mm – 6"	01-1607-01
200 mm – 8"	01-1607-02
250 mm – 9 ¾"	01-1607-03
300 mm – 11 ¼"	01-1607-04
350 mm – 13 ¾"	01-1607-05



MAyo-rUss. 1:2

230 mm – 9"
01-1608



nelson

150 mm – 6"	01-1609-01
180 mm – 7"	01-1609-02
200 mm – 8"	01-1609-03
230 mm – 9"	01-1609-04



sinGley-tUttle

150 mm – 6"	01-1610-01
180 mm – 7"	01-1610-02
230 mm – 9"	01-1610-03
250 mm – 14"	01-1610-04
300 mm – 11 ¾"	01-1610-05



collin-dUvAl

200 mm – 8"
x = 14 mm
01-1611



200 mm – 8"
x = 18 mm
01-1612



200 mm – 8"
x = 27 mm
01-1613

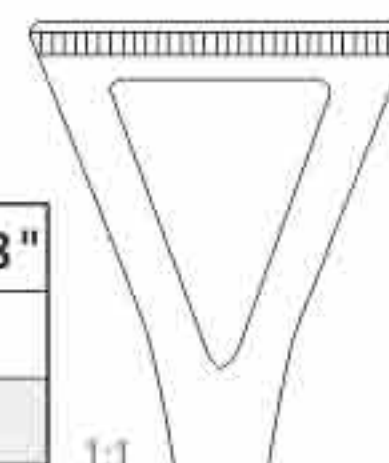

Splinter forceps



feilchenfeld

80 mm – 3"	01-1614-01
90 mm – 3 ½"	01-1614-02
115 mm – 4 ½"	01-1614-03



HUnter

105 mm – 4 ¼"	01-1615	01-1616
---------------	---------	---------

Splinter forceps

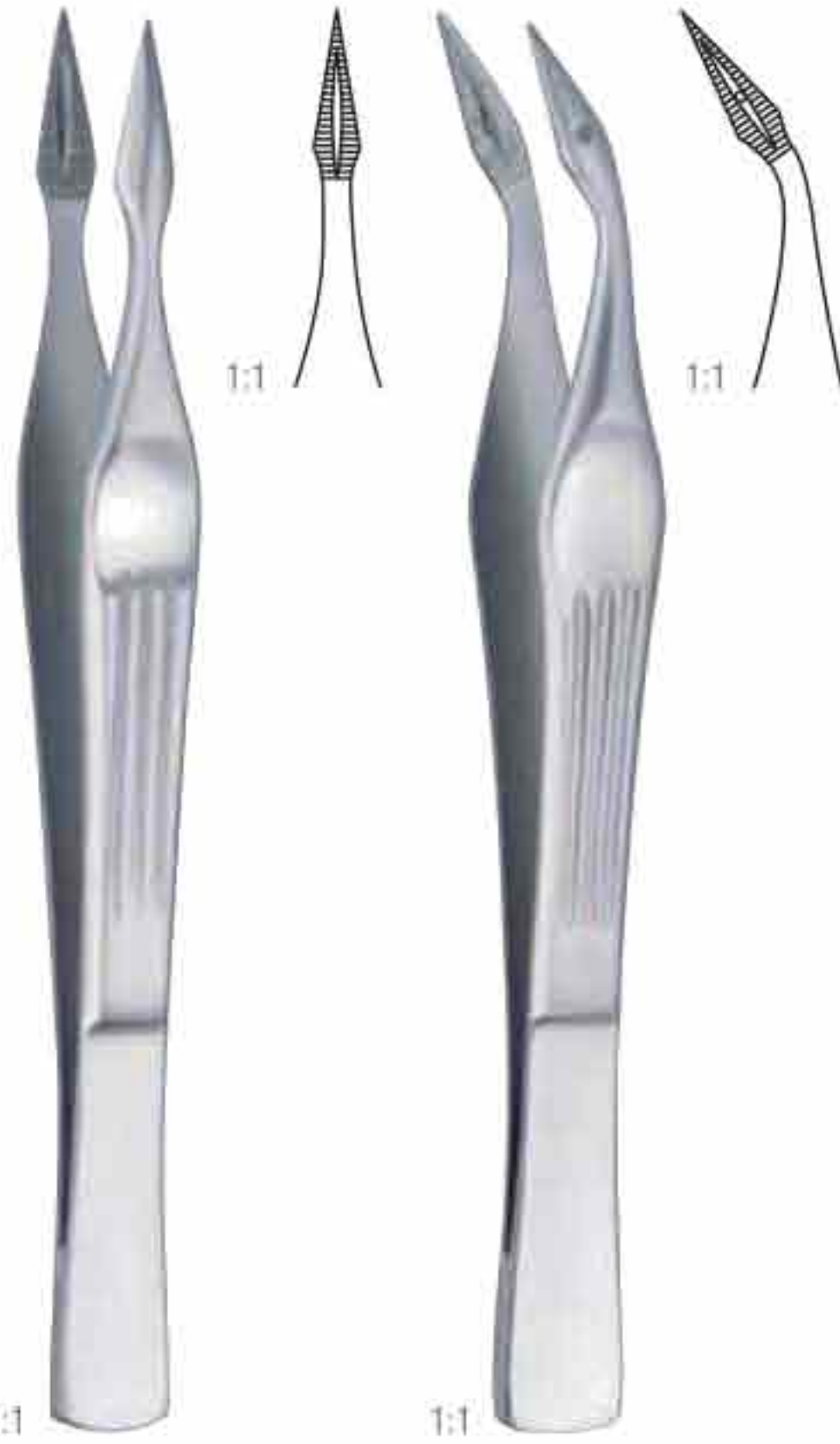

wAlter-
cArMAIt

105 mm - 4 1/4"	01-1617	01-16218
-----------------	---------	----------



80 mm - 3 1/4"	01-1619
----------------	---------



100 mm - 4"	01-1620-01
125 mm - 5"	01-1620-02

Cilia forceps



Beer	1:1
90 mm – 3 ½ "	
01-1621	



doUGIAs	1:1	1:1
90 mm – 3 ½ "	01-1622	01-1623



littAUer	1:1	1:1
85 mm – 3 ¼ "	01-1624	
90 mm – 3 ½ "		01-1625



GrAdle	1:1
95 mm – 3 ¾ "	
01-1626	



BArrAqUer	1:1
105 mm – 4 ¼ "	
01-1627	

Atraumatic tissue forceps

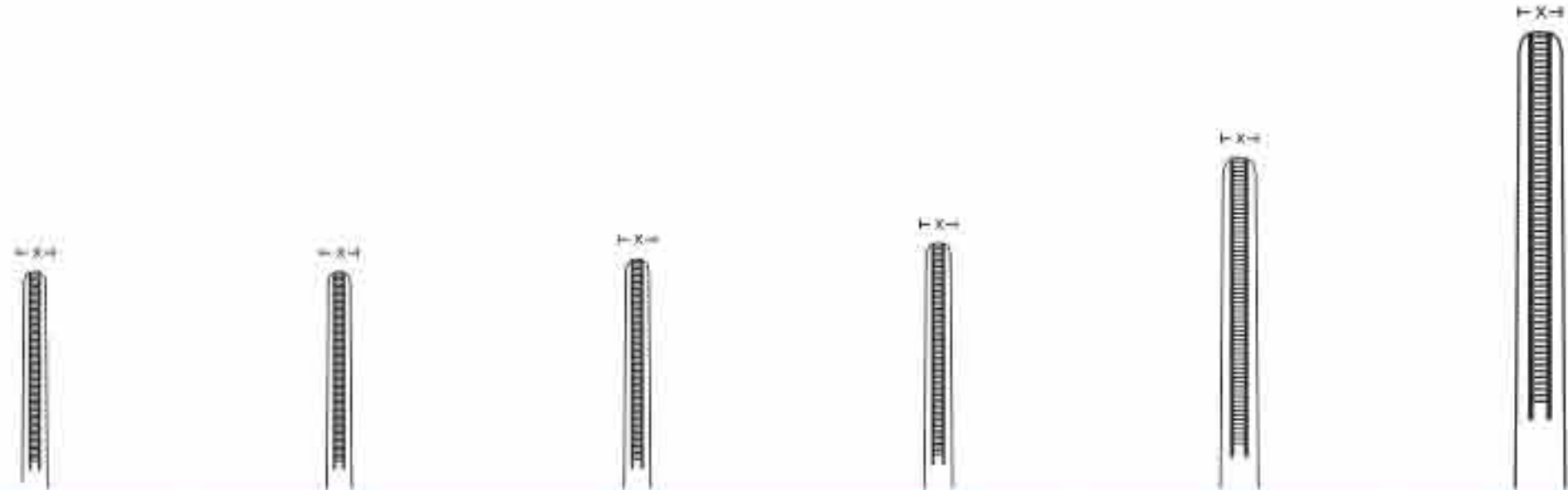

DE BAKEY

	Atrauma	Atrauma	Atrauma	Atrauma	Atrauma	Atrauma
	x = 1.0 mm	x = 1.2 mm	x = 1.5 mm	x = 2.0 mm	x = 2.8 mm	x = 3.5 mm
150 mm – 6 "	01-1628-01	01-1629-01	01-1630-01	01-1631-01	01-1632-01	01-1633-01
200 mm – 8 "	01-1628-02	01-1629-02	01-1630-02	01-1631-02	01-1632-02	01-1633-02
240 mm – 9 ½ "	01-1628-03	01-1629-03	01-1630-03	01-1631-03	01-1632-03	01-1633-03
300 mm – 12 "		01-1629-04	01-1630-04	01-1631-04	01-1632-04	01-1633-04
350 mm – 13 ¾ "				01-1631-05	01-1632-05	01-1633-05
380 mm – 15 "					01-1632-06	01-1633-06
400 mm – 15 ¾ "					01-1632-07	



DE BAKEY

	light weight	light weight	light weight
	x = 1.2 mm	x = 1.5 mm	x = 2.0 mm
150 mm – 6 "	01-1628-01LW		01-1631-01LW
200 mm – 8 "		01-1628-02LW	
240 mm – 9 ½ "		01-1628-03LW	
300 mm – 12 "		01-1628-04LW	

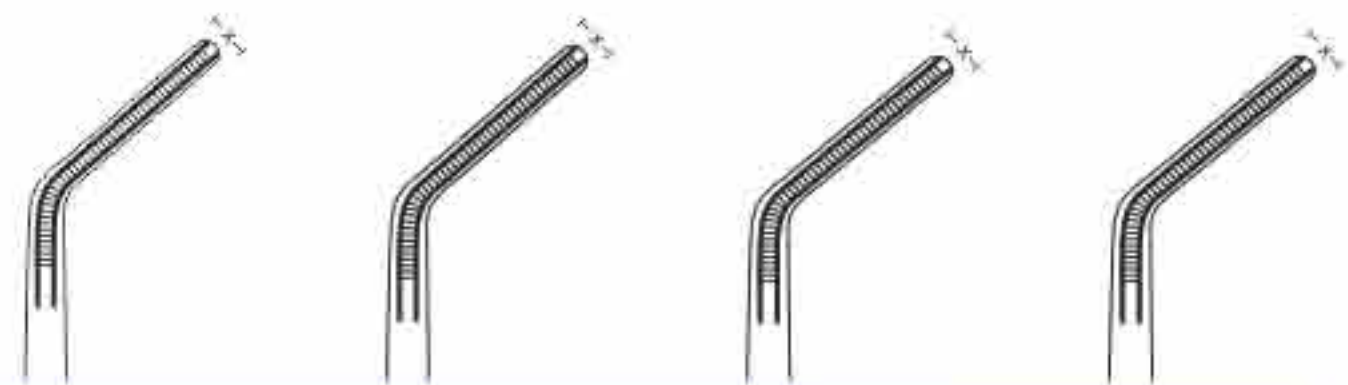

DE BAKEY

	Atrauma	Atrauma	Atrauma	light weight
	x = 1.5 mm	x = 2.0 mm	x = 3.5 mm	x = 2.0 mm
150 mm – 6 "	01-1634	01-1635-01	01-1636-01	01-1635-01LW
200 mm – 8 "		01-1635-02	01-1636-02	
240 mm – 9 ½ "		01-1635-03	01-1636-03	
300 mm – 12 "		01-1635-04	01-1636-04	

Atraumatic tissue forceps



DE BAKEY

	titan / Atrauma	titan / Atrauma	titan / Atrauma	titan / Atrauma	titan / Atrauma	titan / Atrauma	titan / Atrauma
	x = 1.0 mm	x = 1.5 mm	x = 1.8 mm	x = 2.0 mm	x = 2.5 mm	x = 2.8 mm	x = 3.5 mm
150 mm – 6"	01-1637-01	01-1637-01	01-1638-01	01-1639-01	01-1640-01	01-1641-01	01-1642-01
200 mm – 8"	01-1637-02	01-1637-02	01-1638-02	01-1639-02	01-1640-02	01-1641-02	01-1642-02
240 mm – 9 ½"	01-1637-03	01-1637-03	01-1638-03	01-1639-03	01-1640-03	01-1641-03	01-1642-03
300 mm – 12"				01-1639-04	01-1640-04	01-1641-04	01-1642-04
350 mm – 13 ¾"							01-1642-05



DE BAKEY

	titan / Atrauma	titan / Atrauma	titan / Atrauma
	x = 1.5 mm	x = 2.0 mm	x = 2.4 mm
160 mm – 6 ¼"	01-1643-01	01-1644-01	
200 mm – 8"	01-1643-02	01-1644-02	01-1645
240 mm – 9 ½"		01-1644-03	
300 mm – 12"		01-1644-04	

Atraumatic tissue forceps





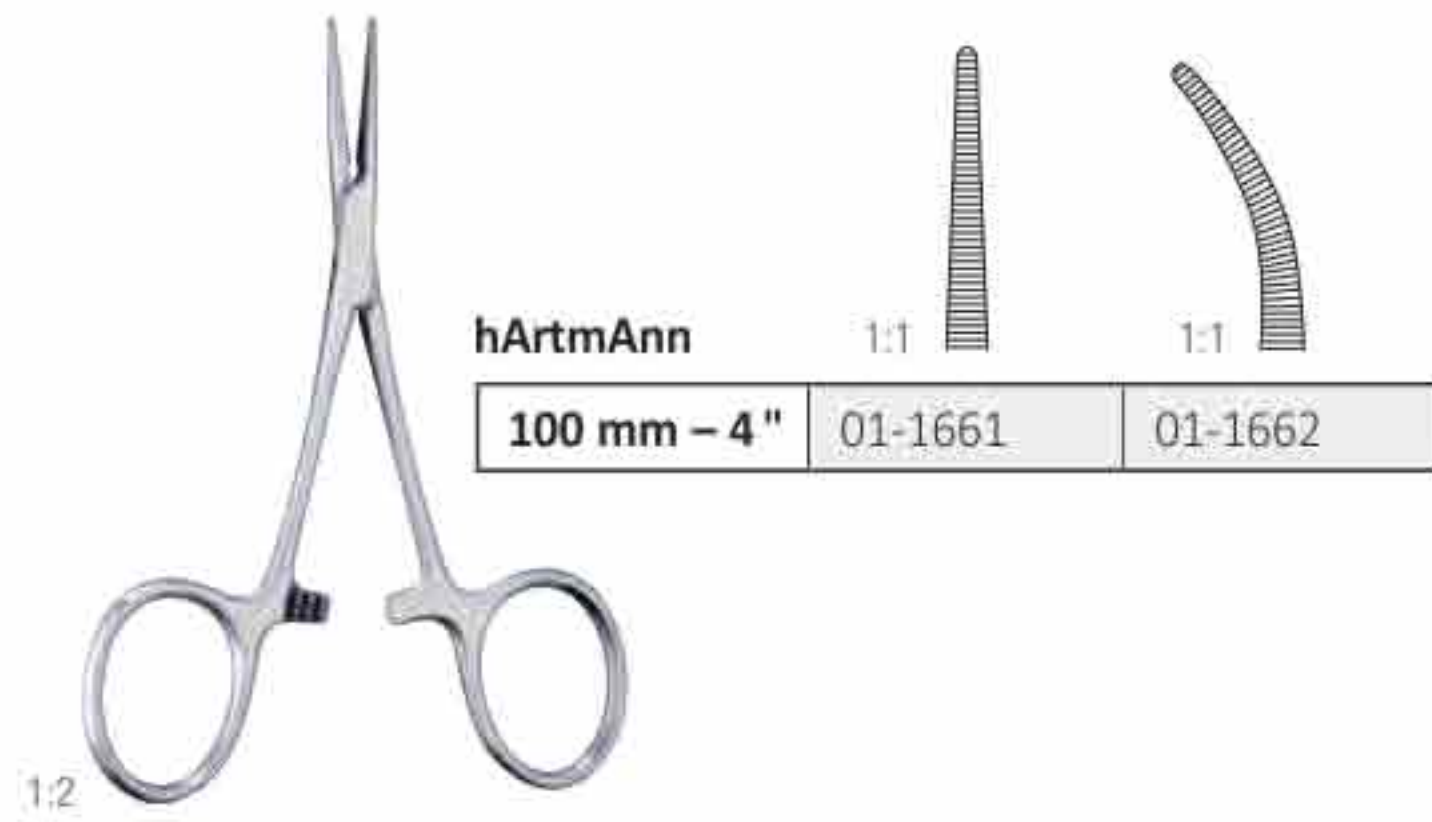

DE BAKEY

	T.C/ Atrauma	T.C/ Atrauma	T.C / Atrauma	T.C/ Atrauma	T.C / Atrauma
	x = 1.5 mm	x = 2.0 mm	x = 2.4 mm	x = 2.7 mm	x = 3.5 mm
150 mm – 6 "	01-1646-01	01-1647-01	01-1648-01	01-1649-01	01-1650-01
200 mm – 8 "	01-1646-02	01-1647-02	01-1648-02	01-1649-02	01-1650-02
240 mm – 9 ½ "	01-1646-03	01-1647-03	01-1648-03	01-1649-03	01-1650-03
300 mm – 12 "	01-1646-04	01-1647-04	01-1648-04	01-1649-04	01-1650-04

Haemostatic forceps



hAlsteD-mosquito

				
125 mm – 5"	01-1664-01	01-1665-01	01-1666-01	01-1667-01
140 mm – 5 1/2"	01-1664-02	01-1665-02	01-1666-02	01-1667-02
			1 x 2	1 x 2
	titan	titan	titan	titan
125 mm – 5"	01-1668	01-1669	01-1670	01-1671
			1 x 2	1 x 2

Haemostatic forceps

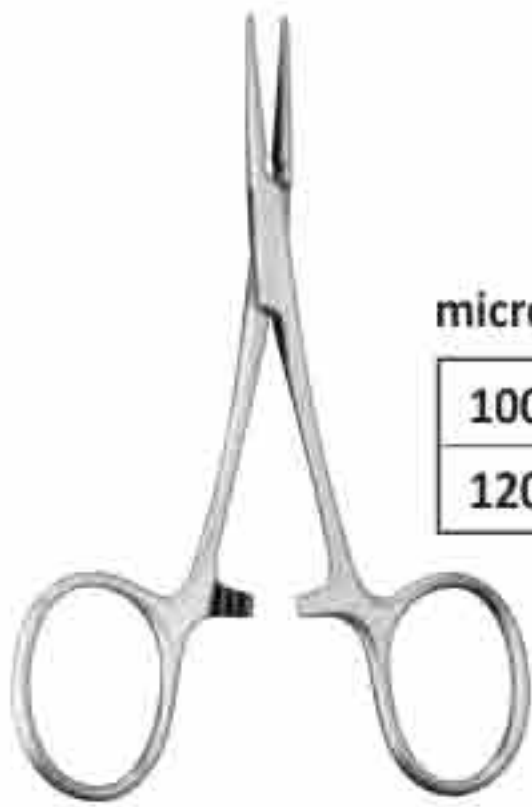

micro-mosquito

100 mm – 4"	01-1672-01	01-1673-01	01-1674-01	01-1675-01
120 mm – 4 ¾"	01-1672-02	01-1673-02	01-1674-02	01-1675-02



1 x 2

1 x 2



DAnDY

130 mm – 4"	01-1676-01	
140 mm – 5 ½"	01-1676-02	01-1677



curved to the side

1 x 2



mosquito-DAnDY

120 mm – 4 ¾"	01-1678
---------------	---------



1:1

curved to the side

1:2

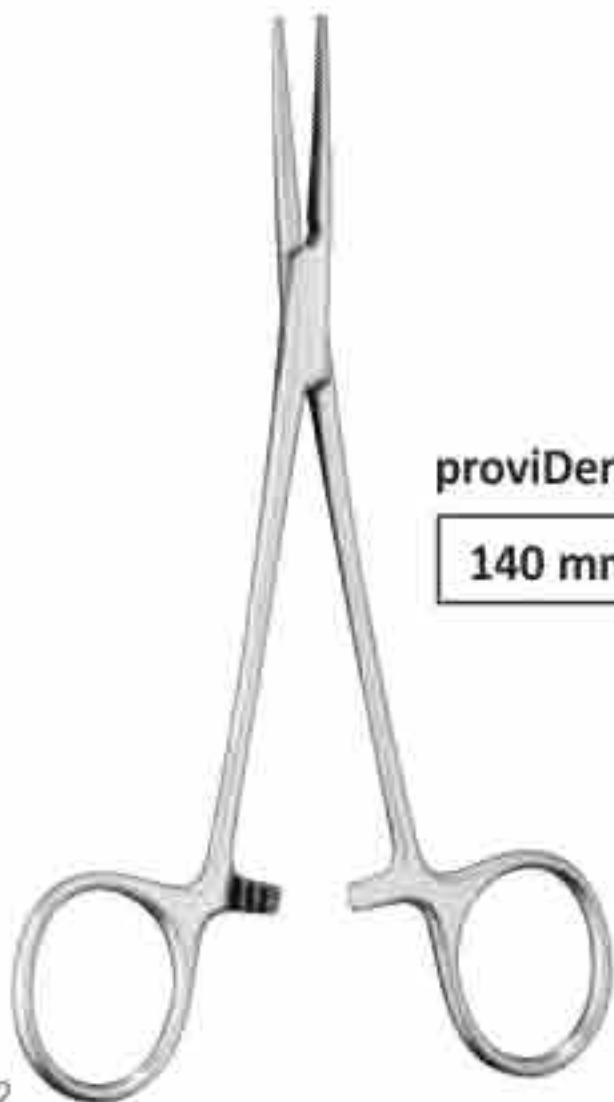

proviDence-hospitAl

140 mm – 5 ½"	01-1679	01-1680
---------------	---------	---------

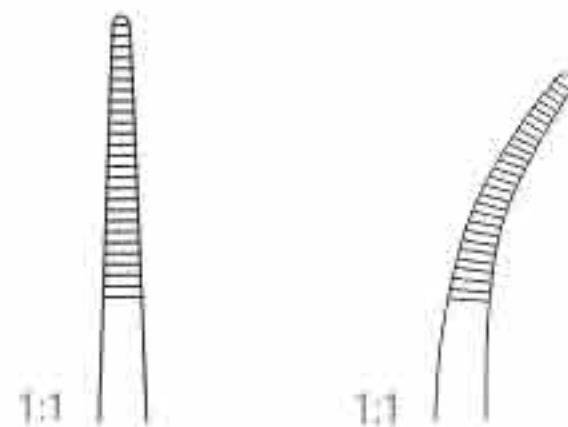

1:1

1:1

1:2

Haemostatic forceps



christophe

130 mm - 4"	01-1681-01
150 mm - 6"	01-1681-02



levelAce

155 mm - 6"	01-1682	01-1683
-------------	---------	---------

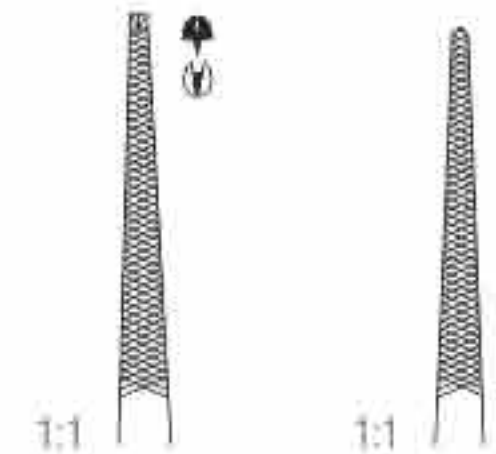

1:1

1:1

1 x 2

1:2



leriche

150 mm - 6"	01-1684	01-1685
-------------	---------	---------

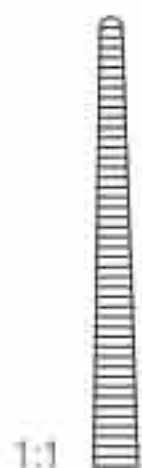

1:1

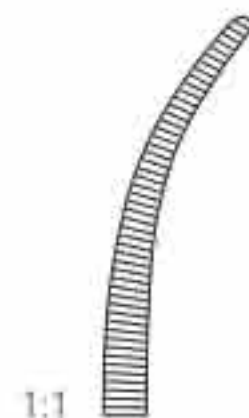

1:1

1:2



leriche

150 mm - 6"	01-1686	01-1687
-------------	---------	---------

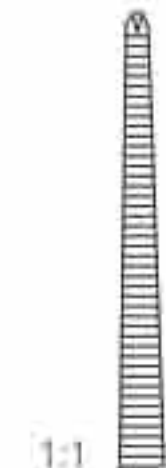

1:1

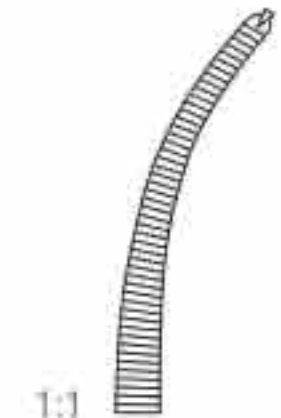

1:1

1 x 2

1:2

Haemostatic forceps

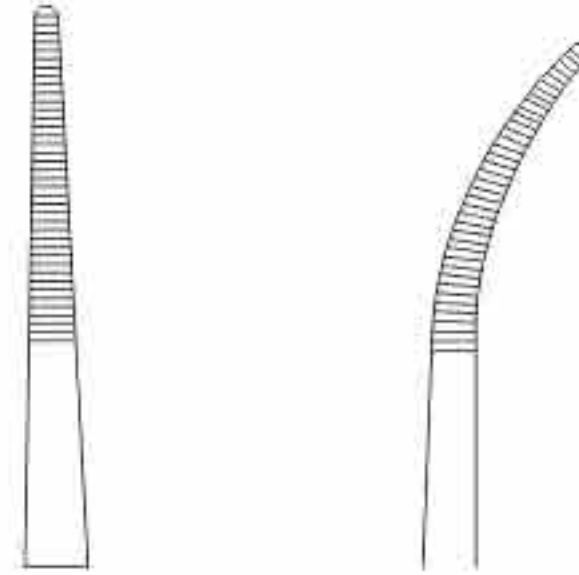

kelly

140 mm – 5 ½ "	01-1688	01-1689
----------------	---------	---------

kelly-rAnkin

160 mm – 6 ¼ "	01-1690	01-1691
----------------	---------	---------

kelly

	titan	titan
140 mm – 5 ½ "	01-1692	01-1693

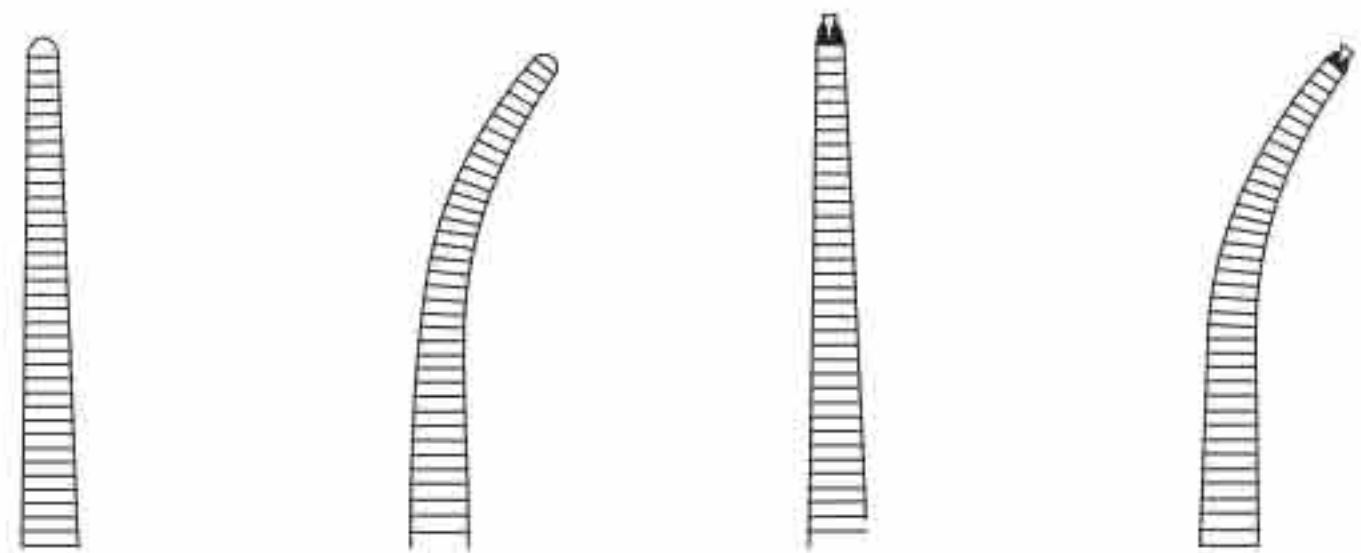

crile

140 mm – 5 ½ "	01-1694	01-1695	01-1696	01-1697
			1 x 2	1 x 2

crile-rAnkin

160 mm – 6 ¼ "	01-1698	01-1699	01-1700	01-1701
			1 x 2	1 x 2

crile

	titan	titan
140 mm – 5 ½ "	01-1702-01	01-1702-02

Haemostatic forceps



coller-crile

140 mm – 5 ½ "	01-1703-01	01-1704-01
160 mm – 6 ¼ "	01-1703-02	01-1704-02

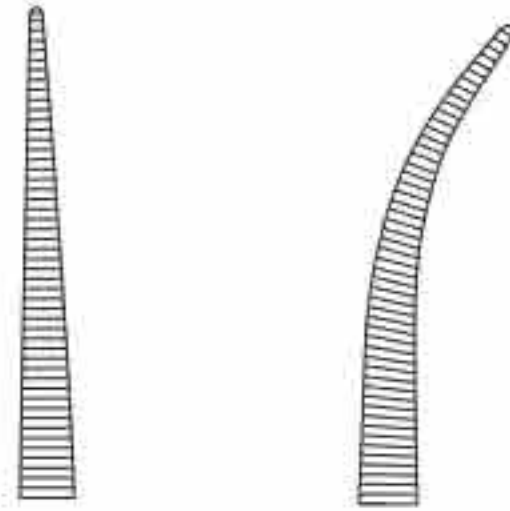

PEAN

130 mm – 5 "	01-1705-01	01-1706-01
140 mm – 5 ½ "	01-1705-02	01-1706-02
160 mm – 6 ¼ "	01-1705-03	01-1706-03

delicate pattern

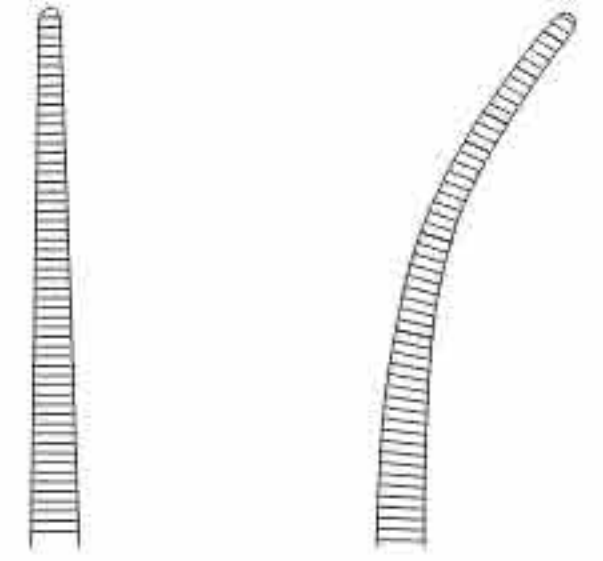

Dunhill

125 mm – 5 "	01-1707	01-1708
--------------	---------	---------

curved

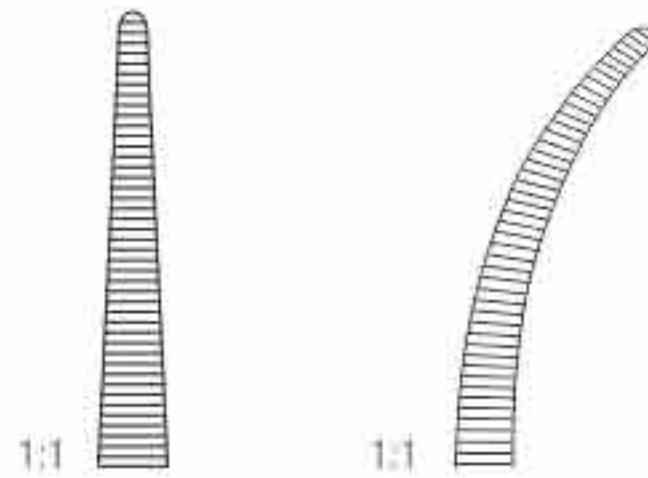

cAirns

150 mm – 6 "	01-1709	01-1710
--------------	---------	---------

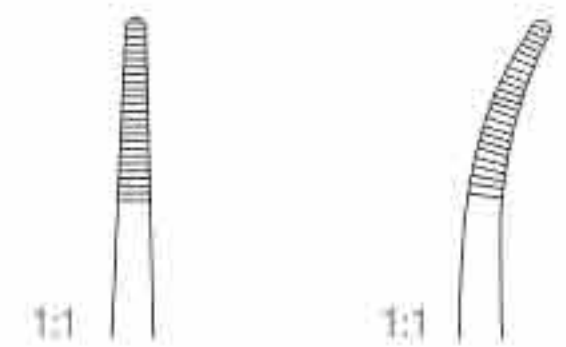

kocher

130 mm – 5 "	01-1711-01	01-1712-01
140 mm – 5 ½ "	01-1711-02	01-1712-02
160 mm – 6 ¼ "	01-1711-03	01-1712-03

delicate pattern

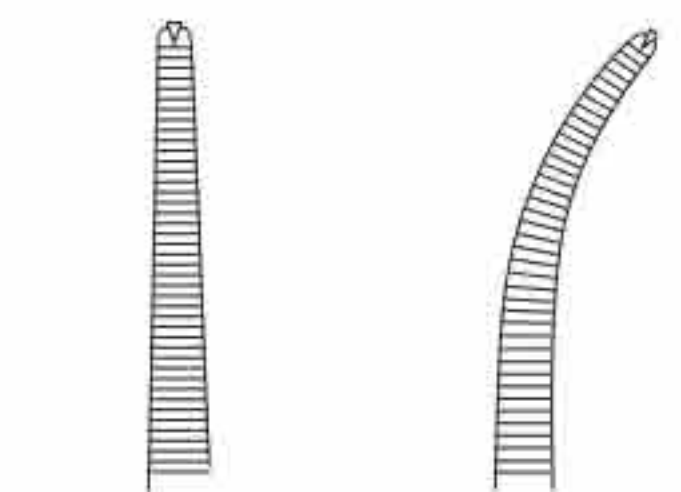

Haemostatic forceps

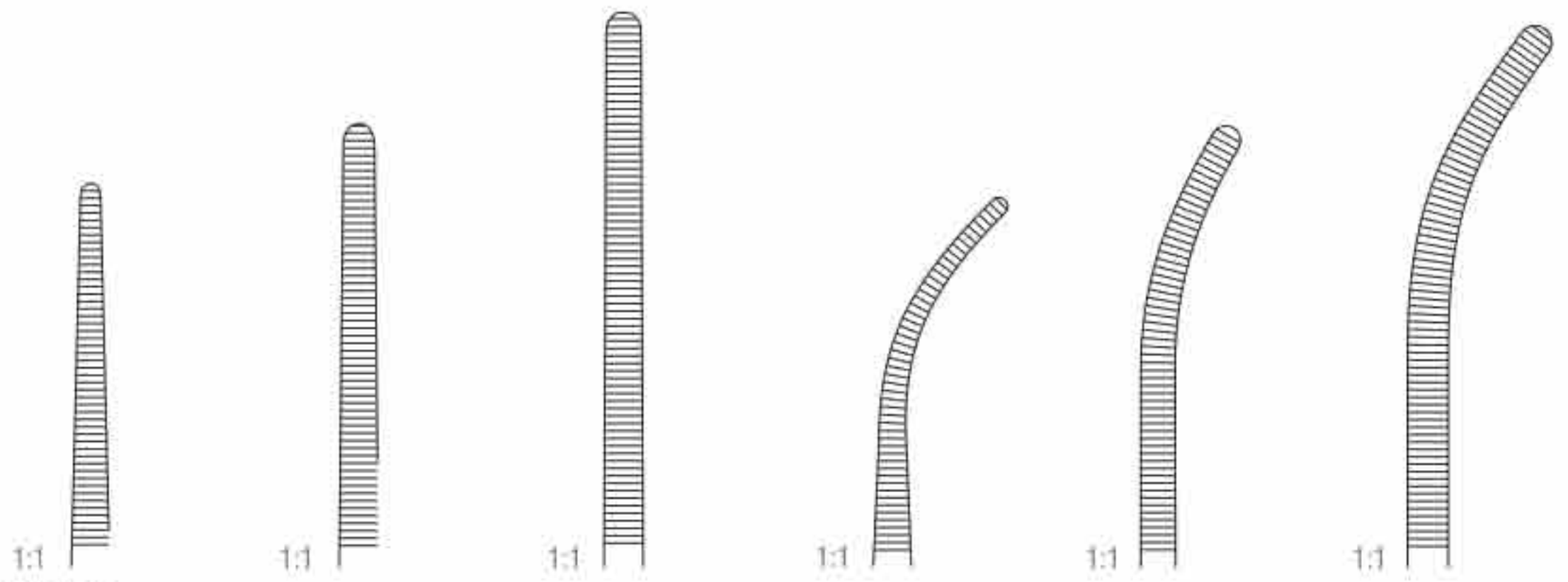

PEAN-FINO

140 mm - 5 1/2 "	165 mm - 6 1/2 "	185 mm - 7 1/4 "	140 mm - 5 1/2 "	160 mm - 6 1/4 "	180 mm - 7 "
01-1713	01-1714	01-1715	01-1716	01-1717	01-1718

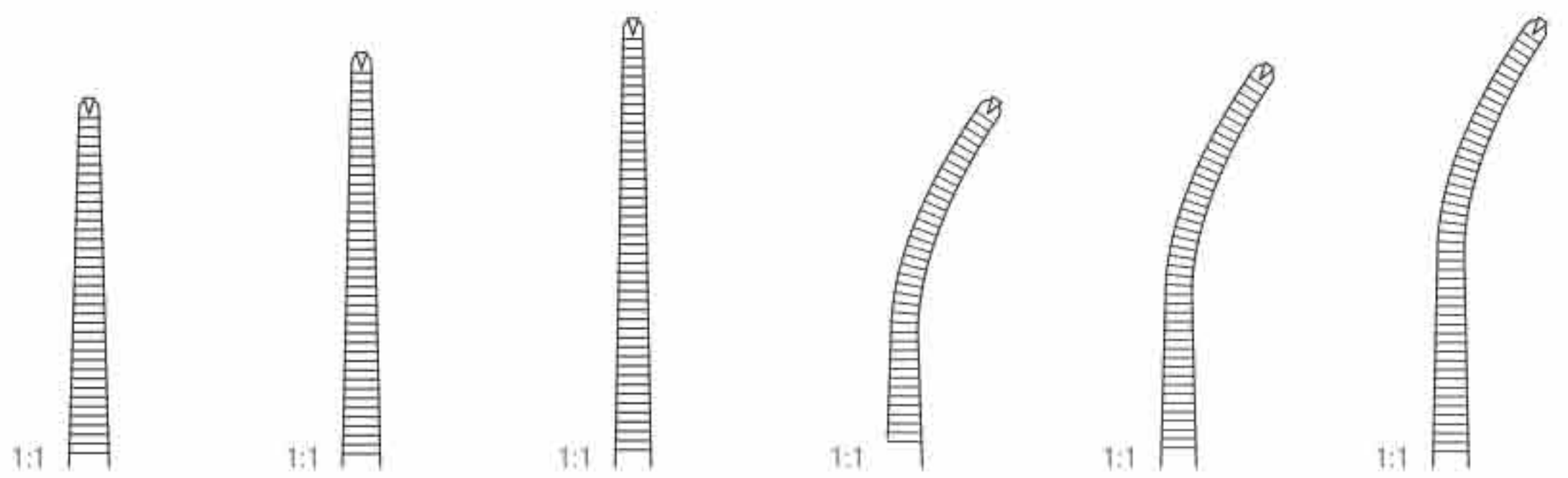

Kocher-Fino

145 mm - 5 3/4 "	165 mm - 6 1/2 "	185 mm - 7 1/4 "	145 mm - 5 3/4 "	160 mm - 6 1/4 "	180 mm - 7 "
01-1719	01-1720	01-1721	01-1722	01-1723	01-1724

1 x 2

1 x 2

1 x 2

1 x 2

1 x 2

1 x 2

Haemostatic forceps

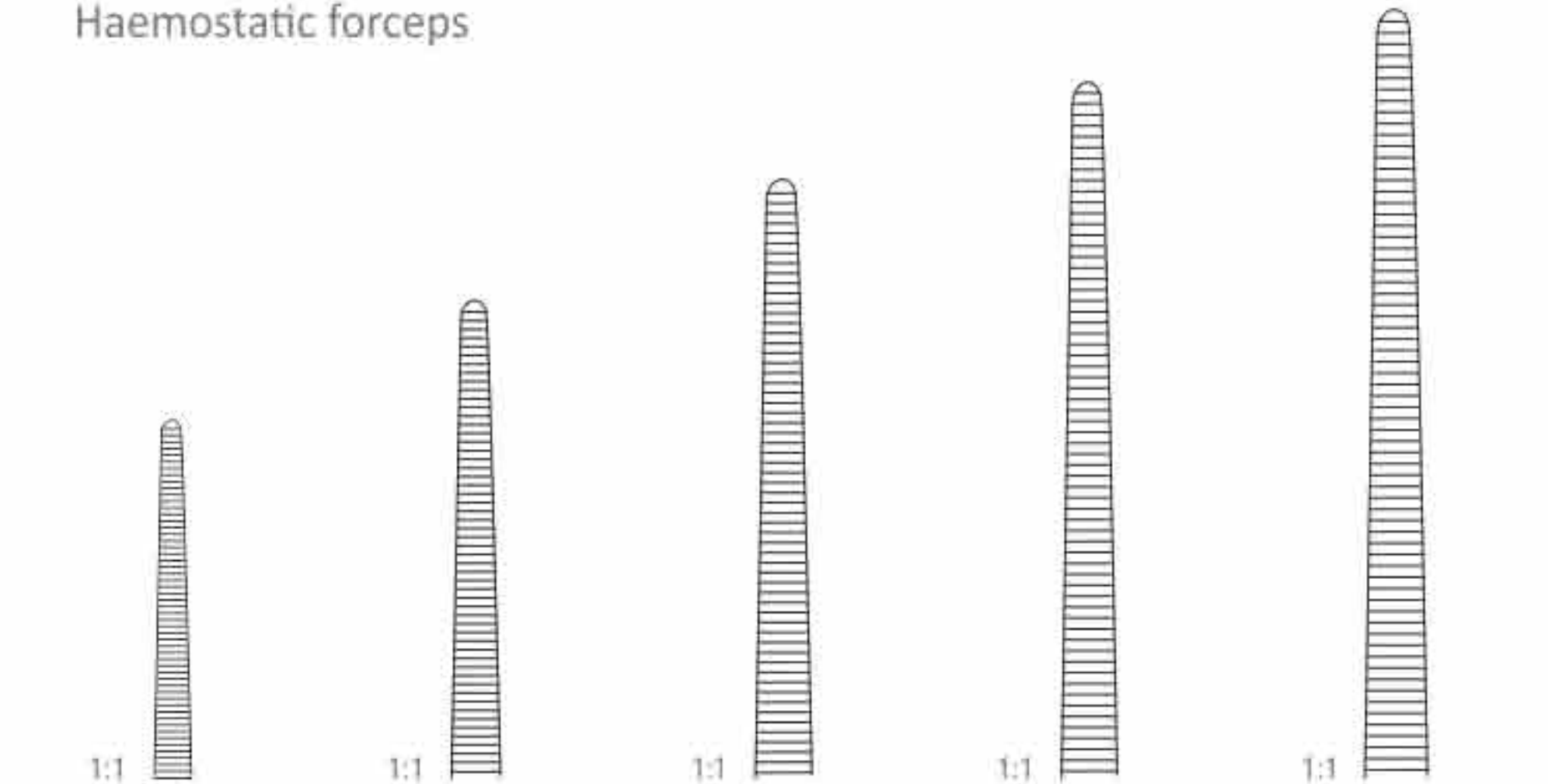

rochester-péAn

130 mm – 5 "	140 mm – 5 ½ "	160 mm – 6 ¼ "	180 mm – 7 "	200 mm – 8 "
01-1725	01-1726	01-1727	01-1728	01-1729

Atrauma	Atrauma	Atrauma	Atrauma
140 mm – 5 ½ "	160 mm – 6 ¼ "	180 mm – 7 "	200 mm – 8 "
01-1730	01-1731	01-1732	01-1733

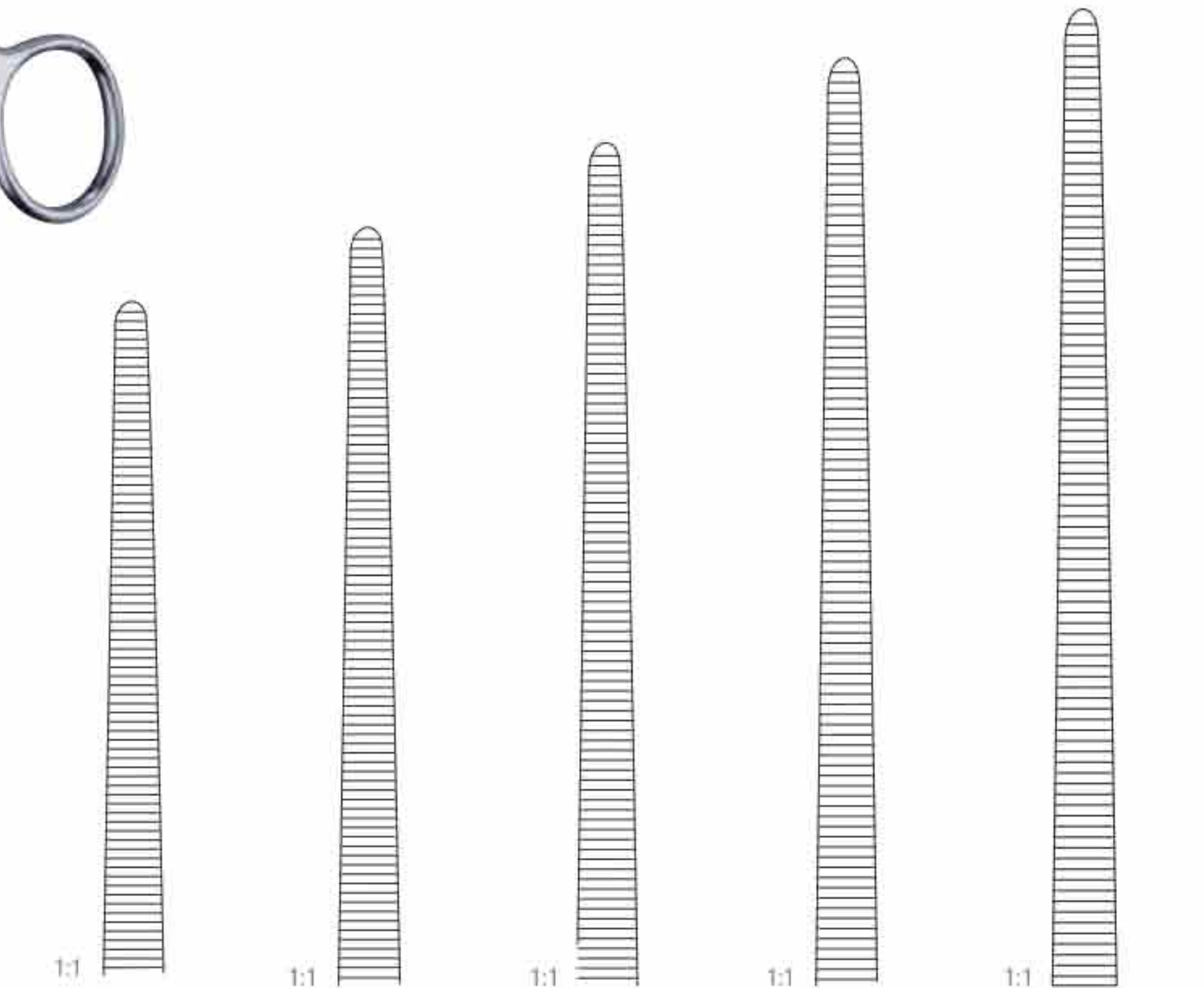

220 mm – 8 ¾ "	240 mm – 9 ½ "	260 mm – 10 ¼ "	300 mm – 12 "	350 mm – 14 "
01-1734	01-1735	01-1736	01-1737	01-1738

Atrauma	Atrauma
260 mm – 10 ¼ "	300 mm – 12 "
01-1739	01-1740

Haemostatic forceps

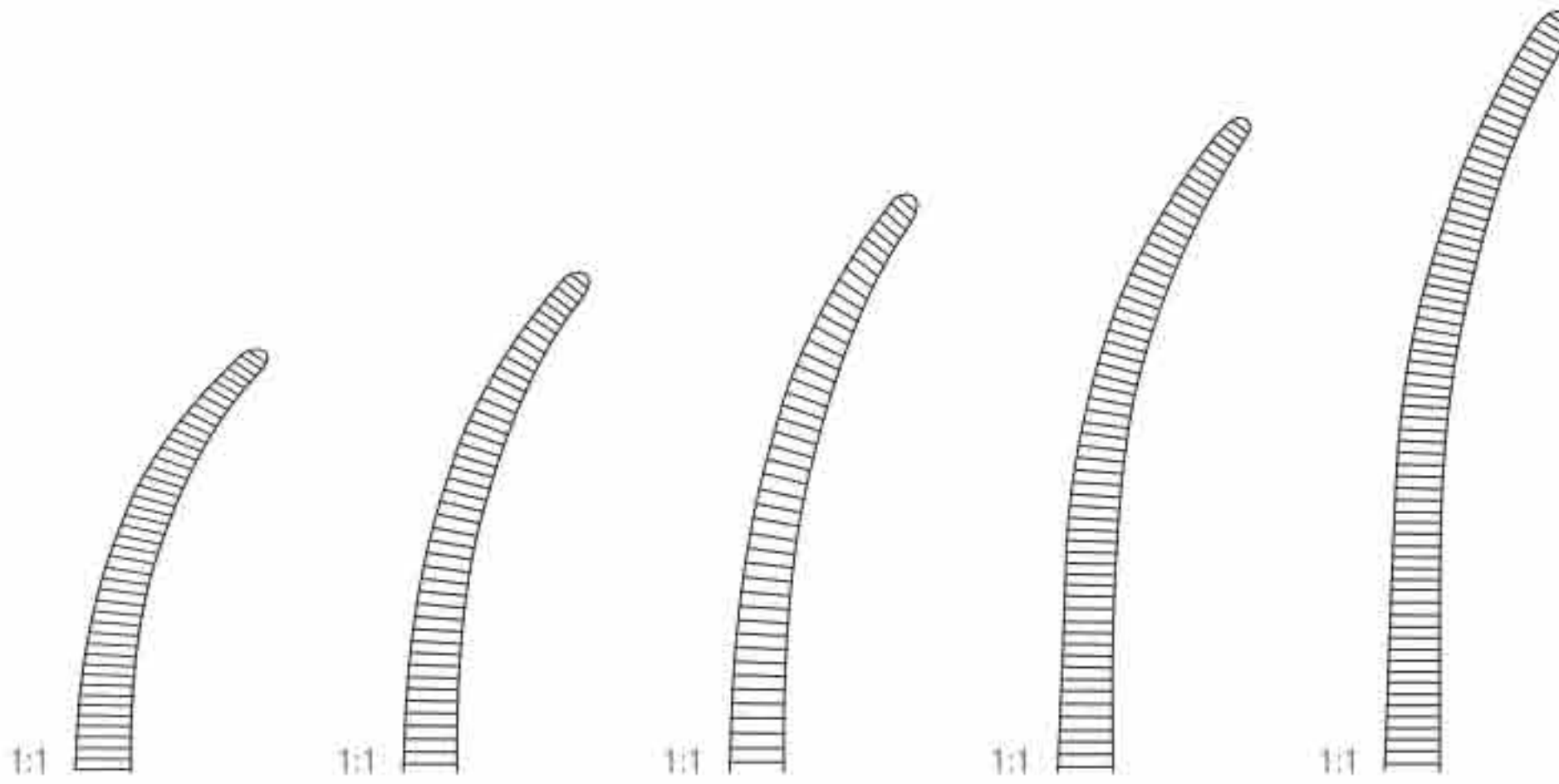

rochester-péAn

130 mm – 5 "	140 mm – 5 ½ "	160 mm – 6 ¼ "	180 mm – 7 "	200 mm – 8 "
01-1741	01-1742	01-1743	01-1744	01-1745

Atrauma	Atrauma	Atrauma	Atrauma
140 mm – 5 ½ "	160 mm – 6 ¼ "	180 mm – 7 "	200 mm – 8 "
01-1746	01-1747	01-1748	01-1749

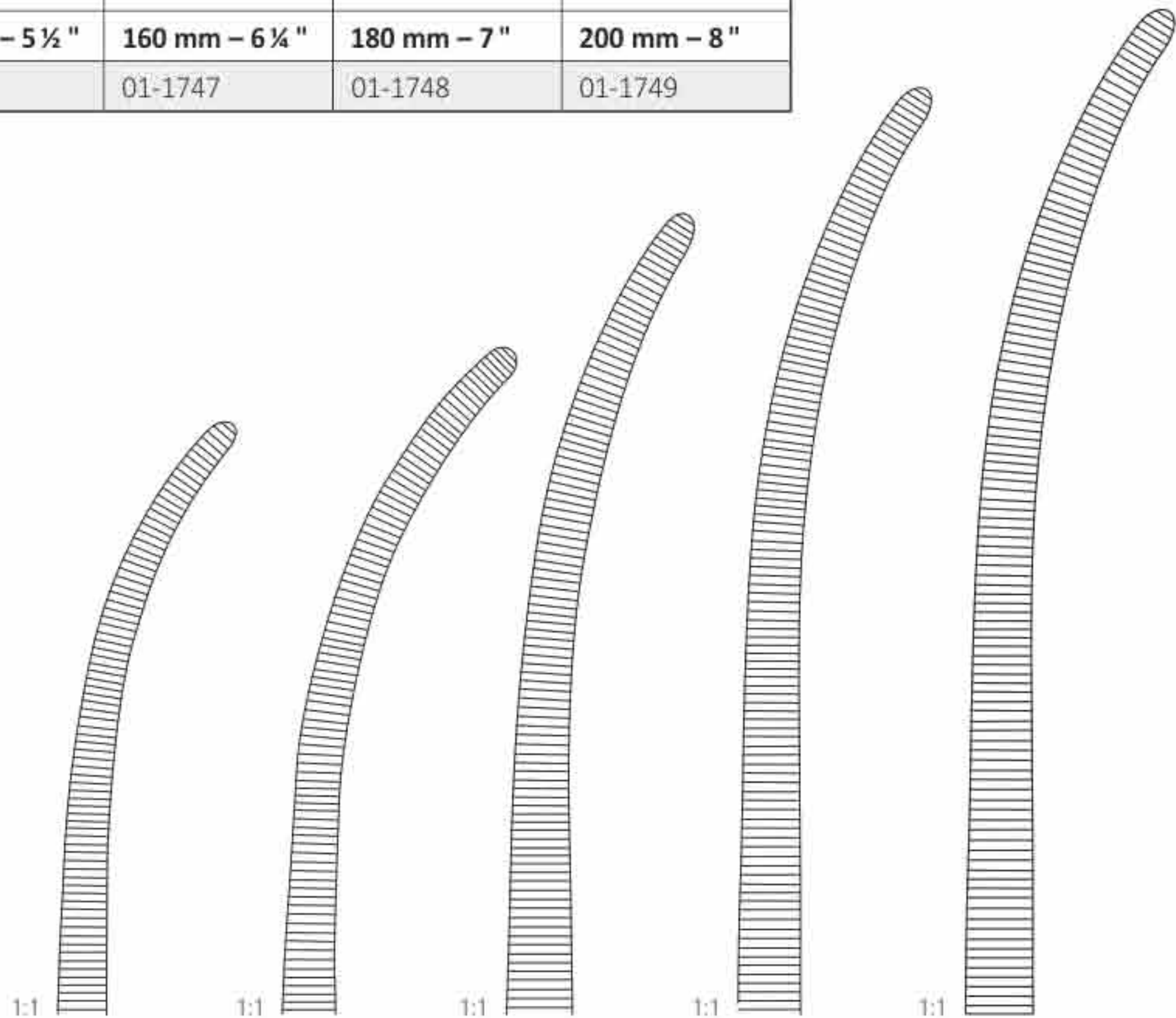

220 mm – 8 ¾ "	240 mm – 9 ½ "	260 mm – 10 ¼ "	300 mm – 12 "	350 mm – 14 "
01-1750	01-1751	01-1752	01-1753	01-1754

Atrauma	Atrauma
260 mm – 10 ¼ "	300 mm – 12 "
01-1755	01-1756

Haemostatic forceps

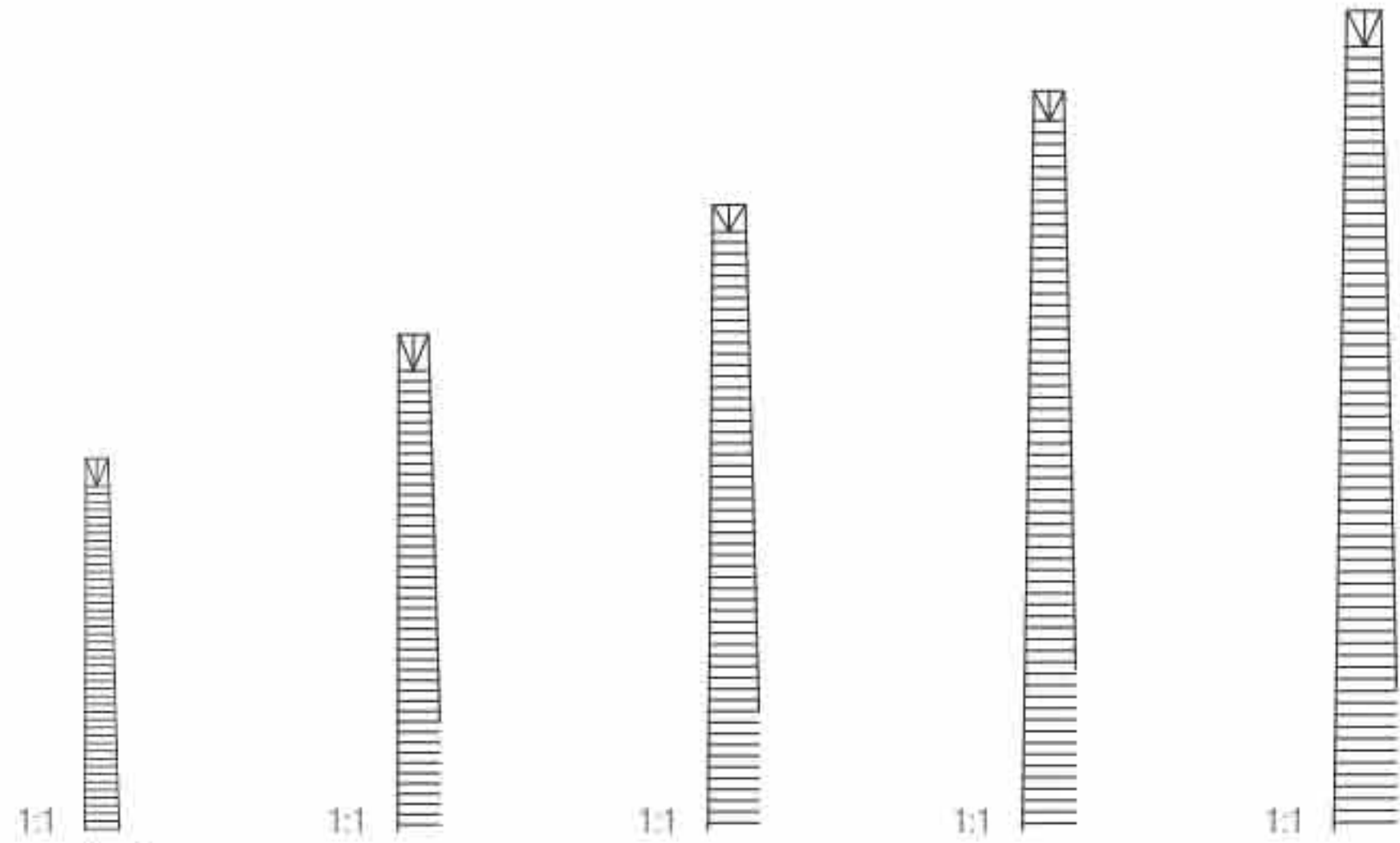
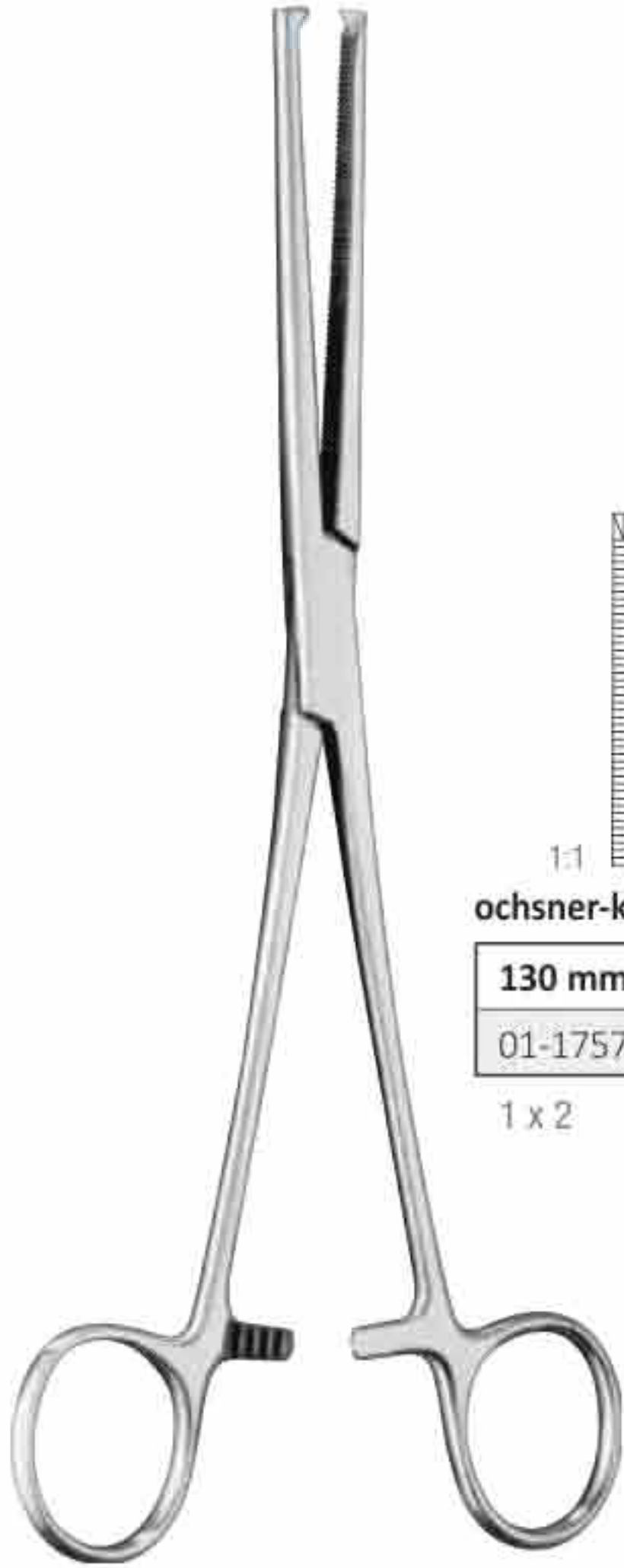

ochsner-kocher

130 mm – 5 "	140 mm – 5 ½ "	160 mm – 6 ¼ "	180 mm – 7 "	200 mm – 8 "
01-1757	01-1758	01-1759	01-1760	01-1761

1 x 2 1 x 2 1 x 2 1 x 2 1 x 2

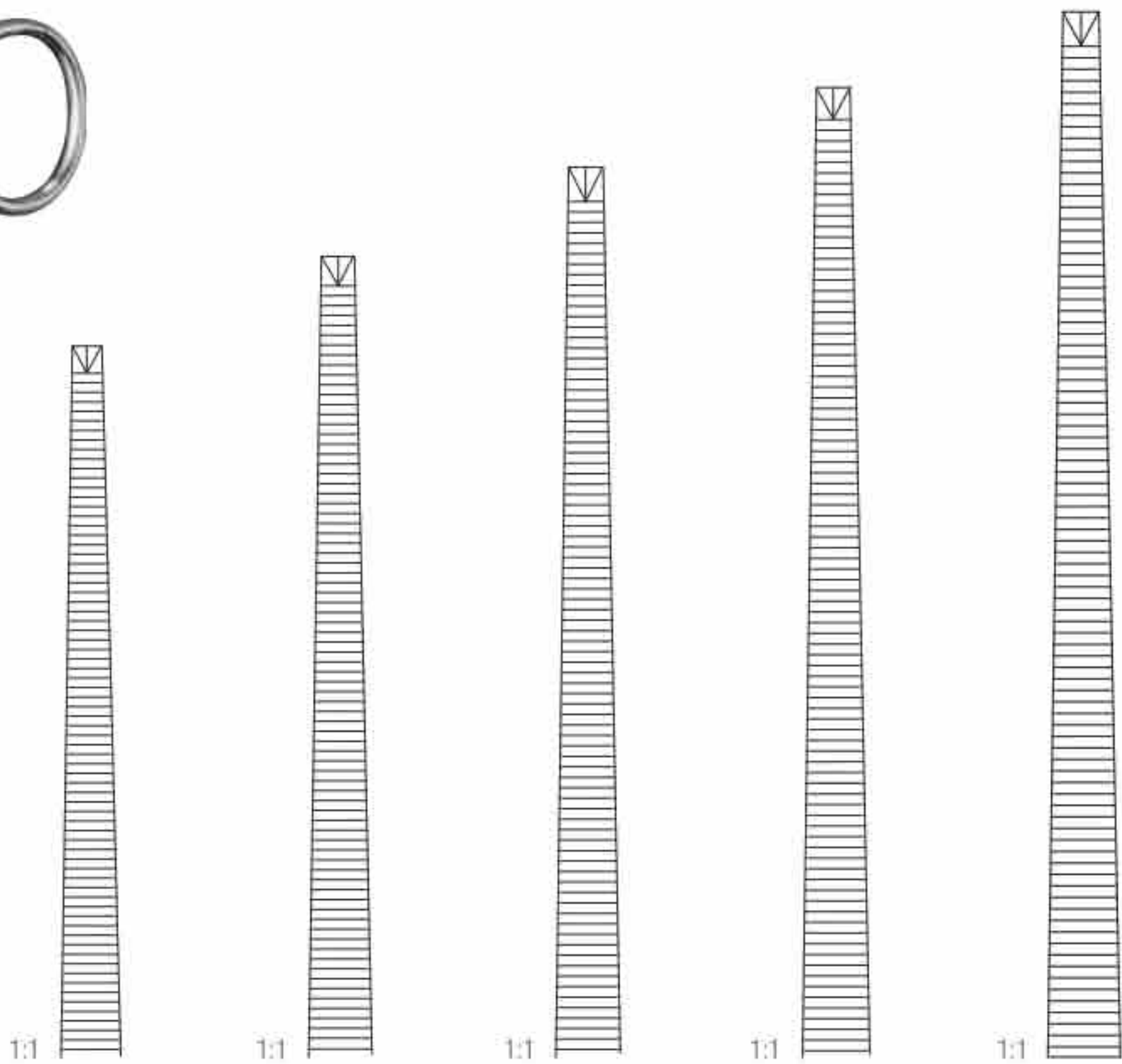

220 mm – 8 ¾ "	240 mm – 9 ½ "	260 mm – 10 ¼ "	300 mm – 12 "	300 mm – 14 "
01-1762	01-1763	01-1764	01-1765	01-1766

1 x 2 1 x 2 1 x 2 1 x 2 1 x 2

Haemostatic forceps

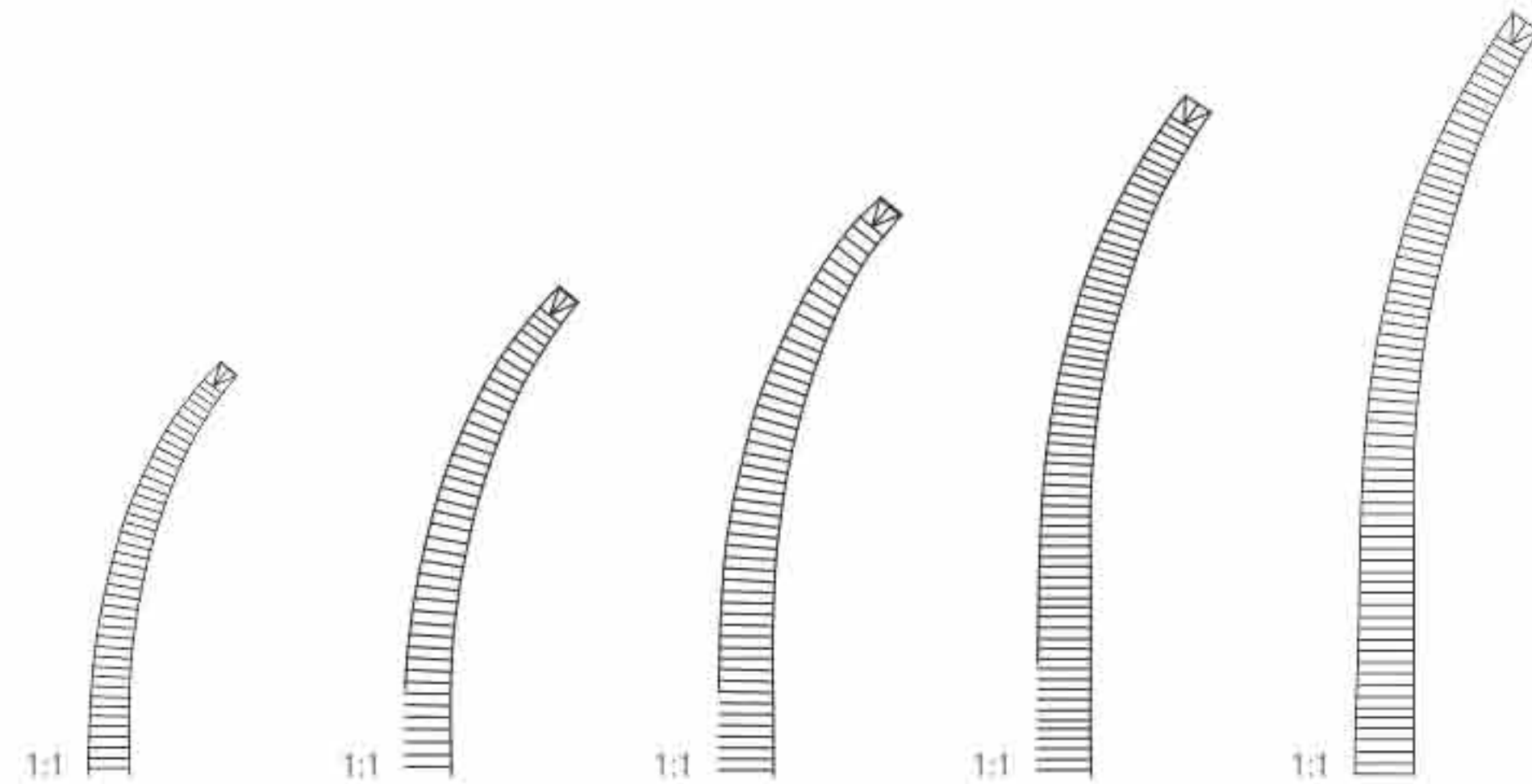

1:1 1:1 1:1 1:1 1:1

ochsner-kocher

130 mm – 5 "	140 mm – 5 ½ "	160 mm – 6 ¼ "	180 mm – 7 "	200 mm – 8 "
01-1767	01-1768	01-1769	01-1770	01-1771
1 x 2	1 x 2	1 x 2	1 x 2	1 x 2

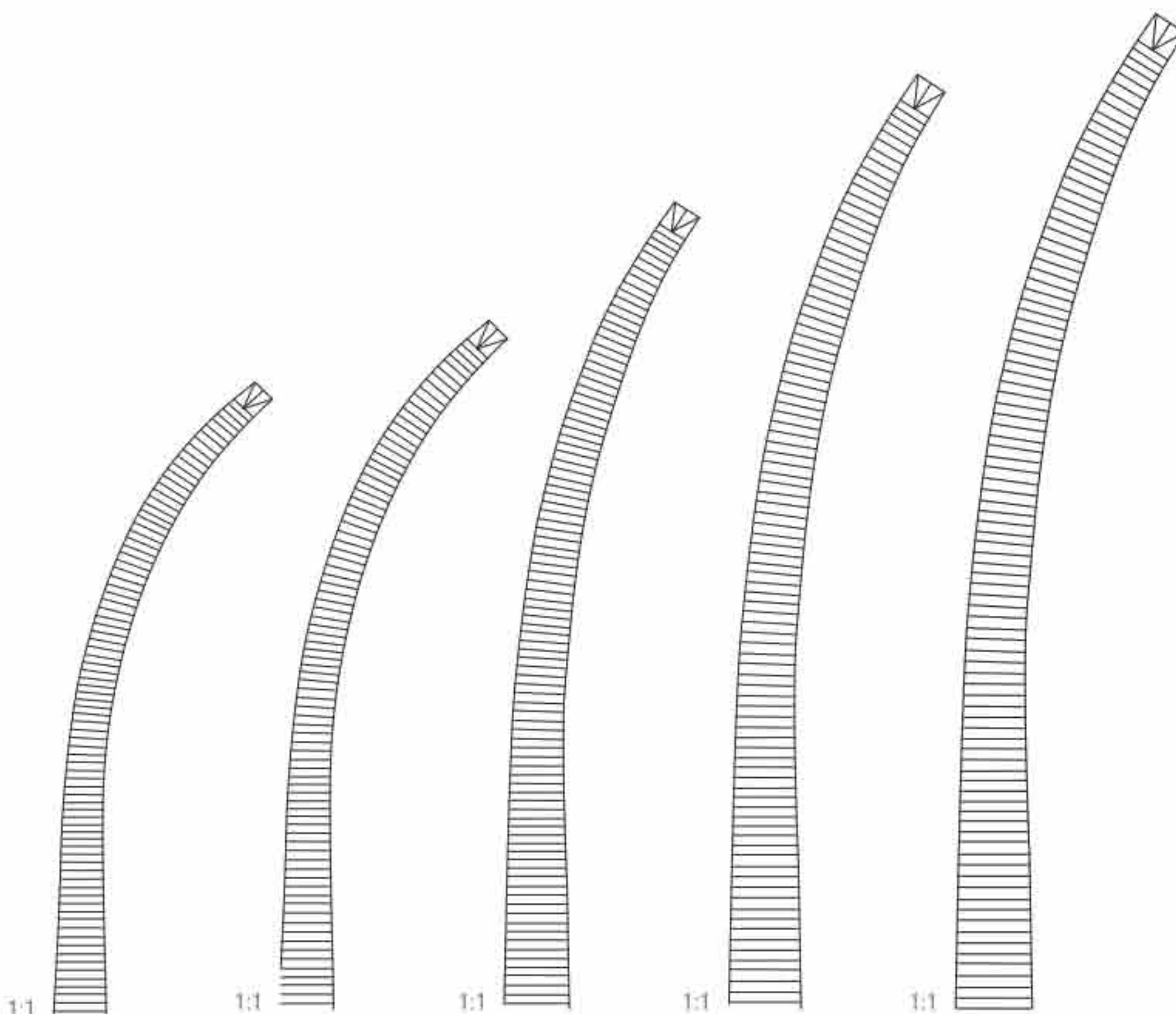

1:1 1:1 1:1 1:1 1:1

220 mm – 8 ¾ "	240 mm – 9 ½ "	260 mm – 10 ¼ "	300 mm – 12 "	350 mm – 14 "
01-1772	01-1773	01-1774	01-1775	01-1776
1 x 2	1 x 2	1 x 2	1 x 2	1 x 2

Haemostatic forceps



birkett

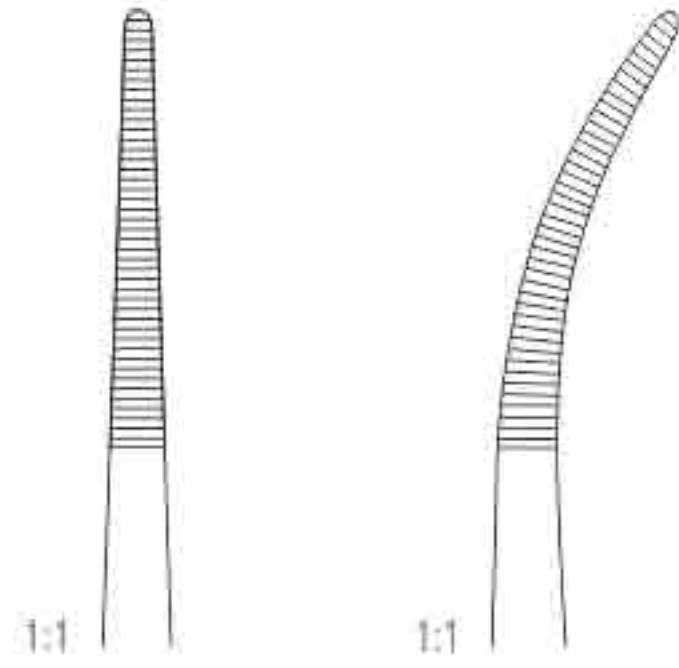

190 mm – 7 ½ "	01-1777	01-1778
----------------	---------	---------



bAinbriDGe

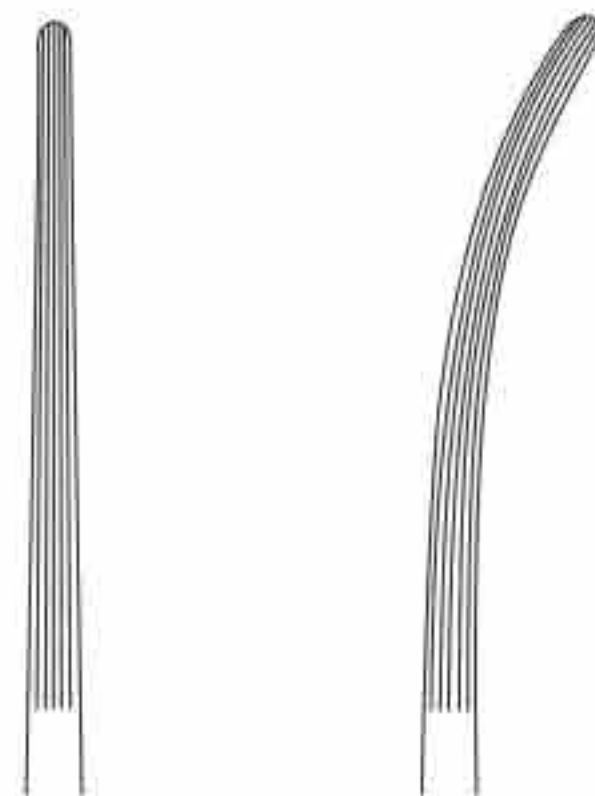

150 mm – 6 "	01-1779-01	01-1780-01
185 mm – 7 ¼ "	01-1779-02	01-1780-02

Haemostatic forceps



péAn

140 mm – 5 ½ "	01-1781-01
160 mm – 6 ¼ "	01-1781-02



rochester-cArmAlt

160 mm – 6 ¼ "	01-1782-01	01-1783-01
200 mm – 8 "	01-1782-02	01-1783-02



Haemostatic forceps



1:2
chAput

130 mm – 5"	01-1784
-------------	---------



1:2
tuffier

130 mm – 5"	01-1785
-------------	---------



penninGton

155 mm – 6"	01-1786-01
200 mm – 8"	01-1786-02



1:2
collin

140 mm – 5½"	01-1787
--------------	---------



1:2
prAtt

150 mm – 6"	01-1788
-------------	---------



1:2
mArtel

140 mm – 5½"	01-1789
--------------	---------

Haemostatic forceps



ferGusson

160 mm – 6 ¼ "	01-1790-01	01-1791-01
200 mm – 8 "	01-1790-02	01-1791-02

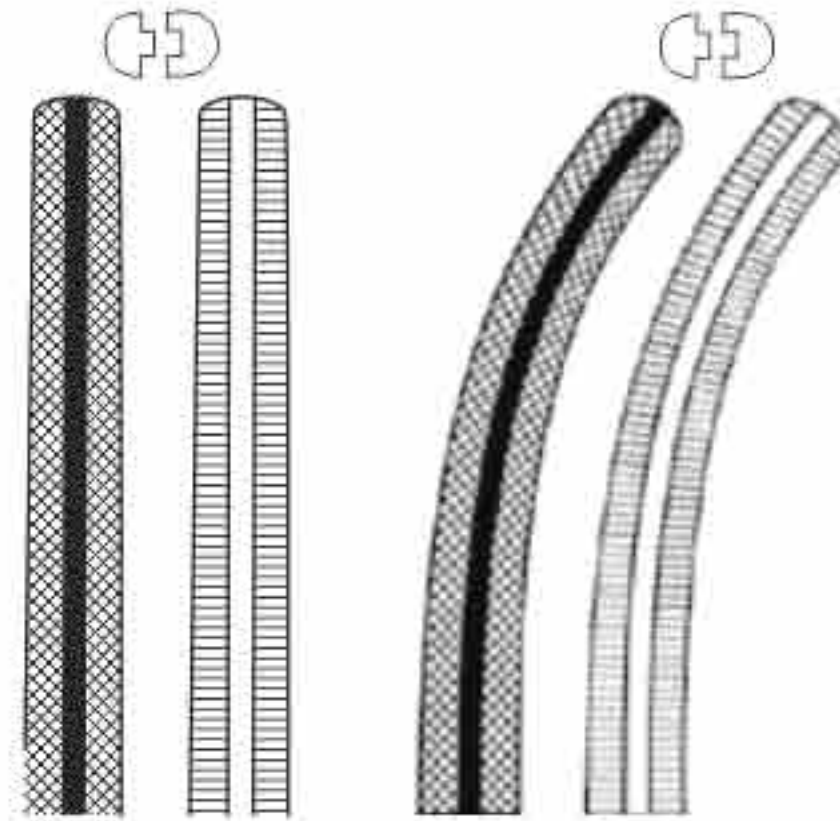

curved



spencer-Wells

130 mm – 5 "	01-1792-01	01-1793-01
140 mm – 5 ½ "	01-1792-02	01-1793-02
155 mm – 6 "	01-1792-03	01-1793-03
180 mm – 7 "	01-1792-04	01-1793-04
200 mm – 8 "	01-1792-05	01-1793-05

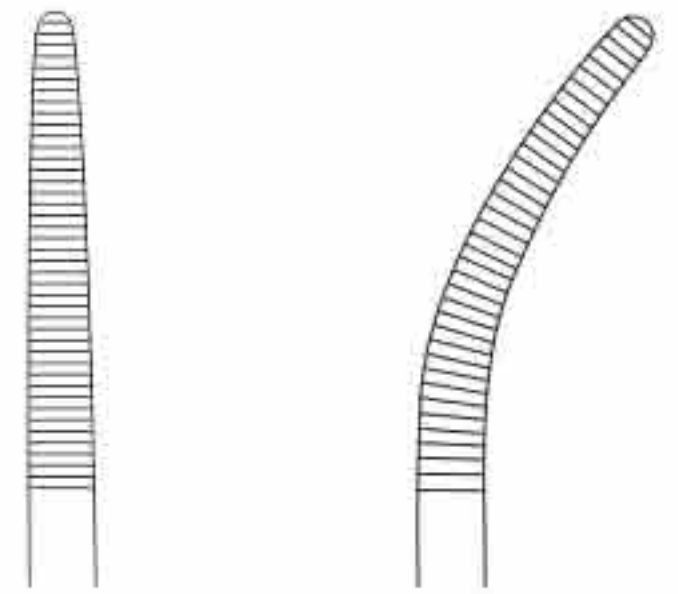

hAlsteD-mosquito

180 mm – 7 "	01-1794-01	01-1795-01	01-1796-01	01-1797-01
210 mm – 8 ¼ "	01-1794-02	01-1795-02	01-1796-02	01-1797-02

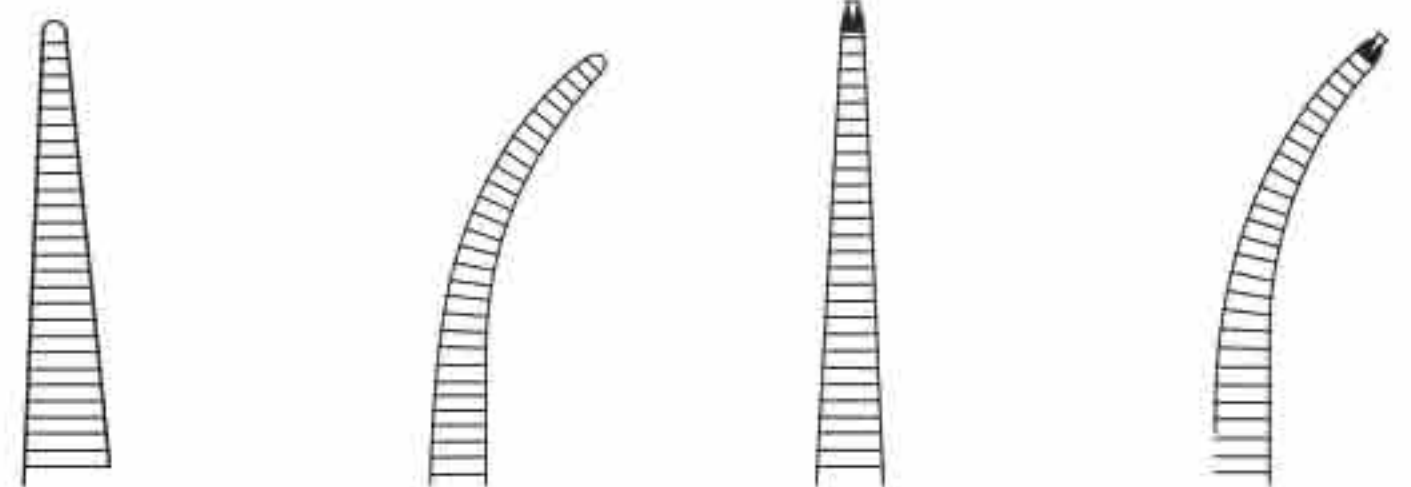

1 x 2

1 x 2

Haemostatic forceps



benGoleA

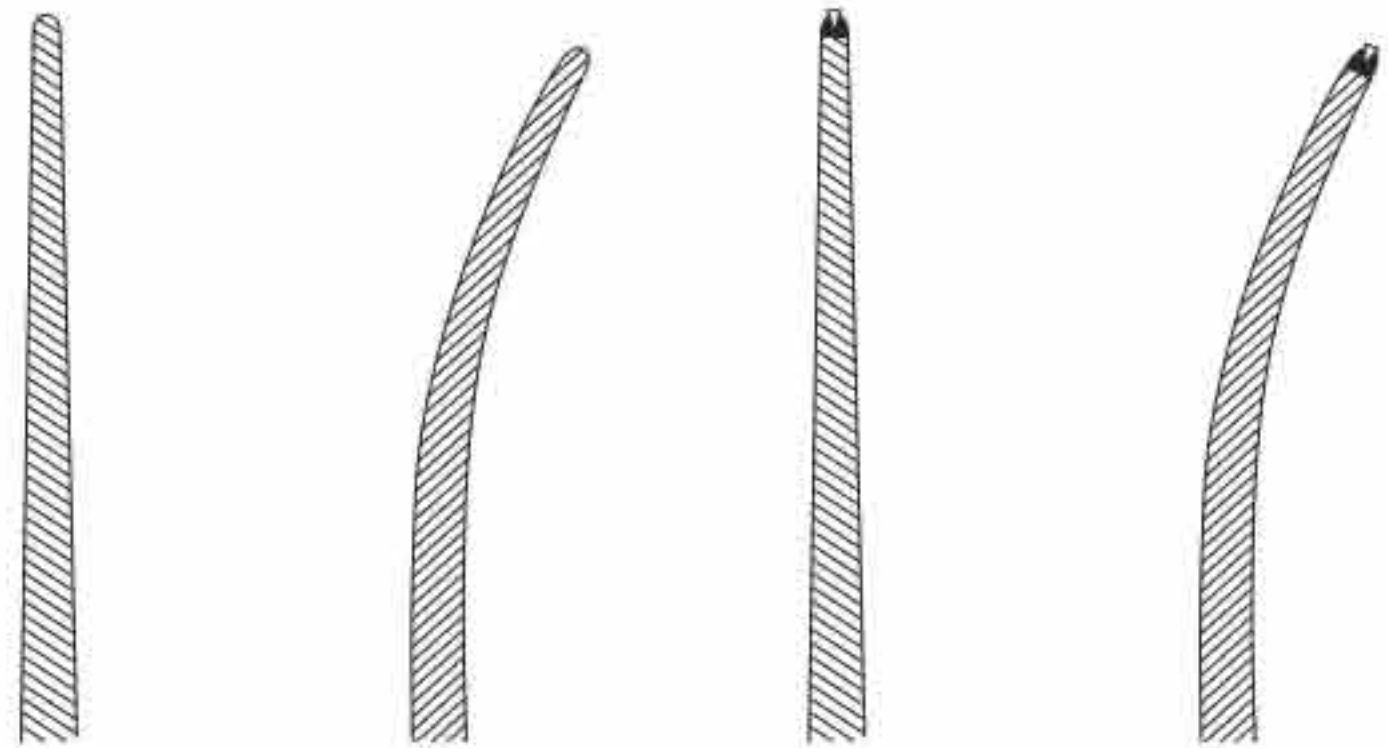

200 mm – 8 "	01-1798-01	01-1799-01	01-1800-01	01-1801-01
260 mm – 10 ¼ "	01-1798-02	01-1799-02	01-1800-02	01-1801-02

1 x 2

1 x 2



1:2

ADson

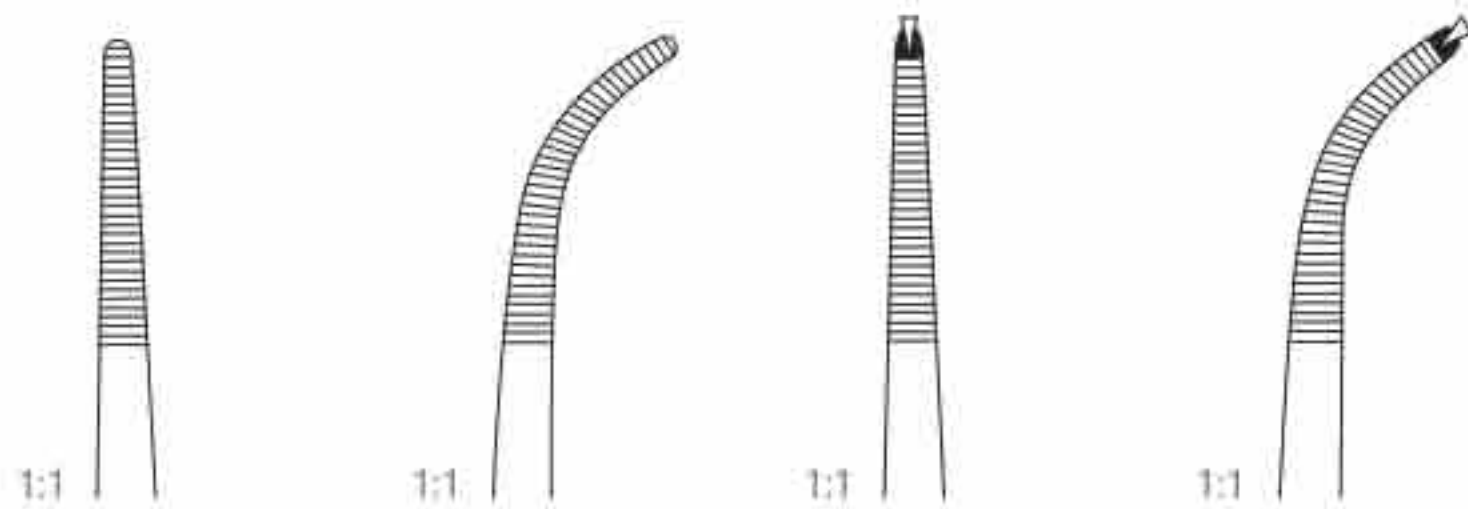

185 mm – 7 ¼ "	01-1802	01-1803	01-1804	01-1805
-----------------------	---------	---------	---------	---------

1 x 2

1 x 2

Haemostatic forceps

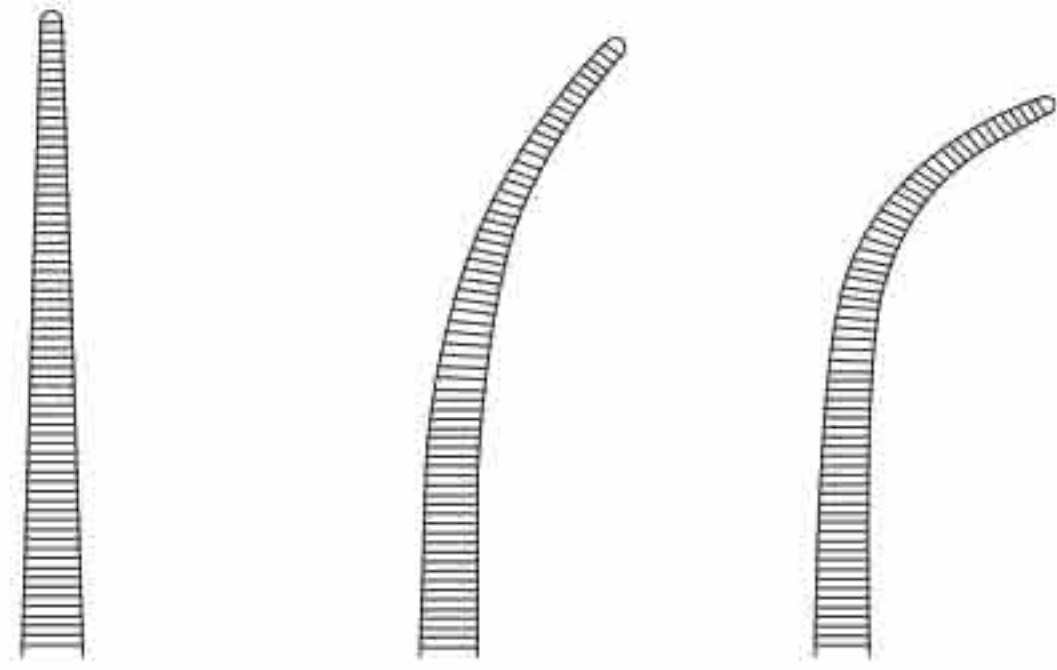

heiss

200 mm – 8"	01-1806-01	01-1807-01	01-1808-01
230 mm – 9"	01-1806-02	01-1807-02	01-1808-02

Haemostatic forceps



bAbY-mixer

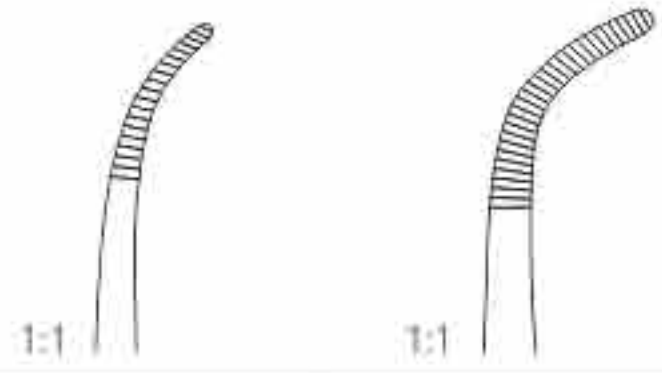

140 mm – 5 ½ "	01-1809	
180 mm – 7 "		01-1810



bAbY-ADson

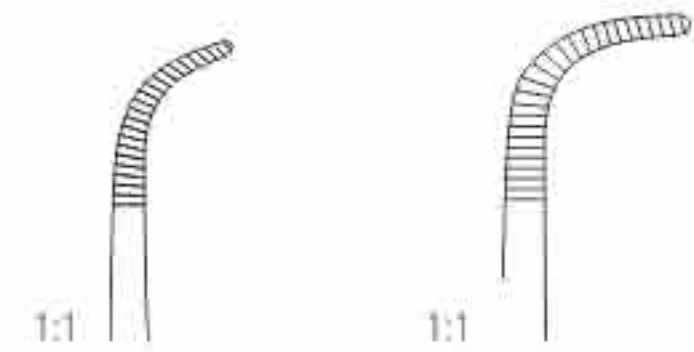

140 mm – 5 ½ "	01-1811	
180 mm – 7 "		01-1812



bAbY-overholt

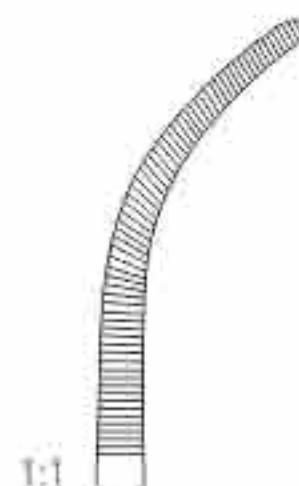

135 mm – 5 ¼ "	01-1813
----------------	---------

1:2

Haemostatic forceps

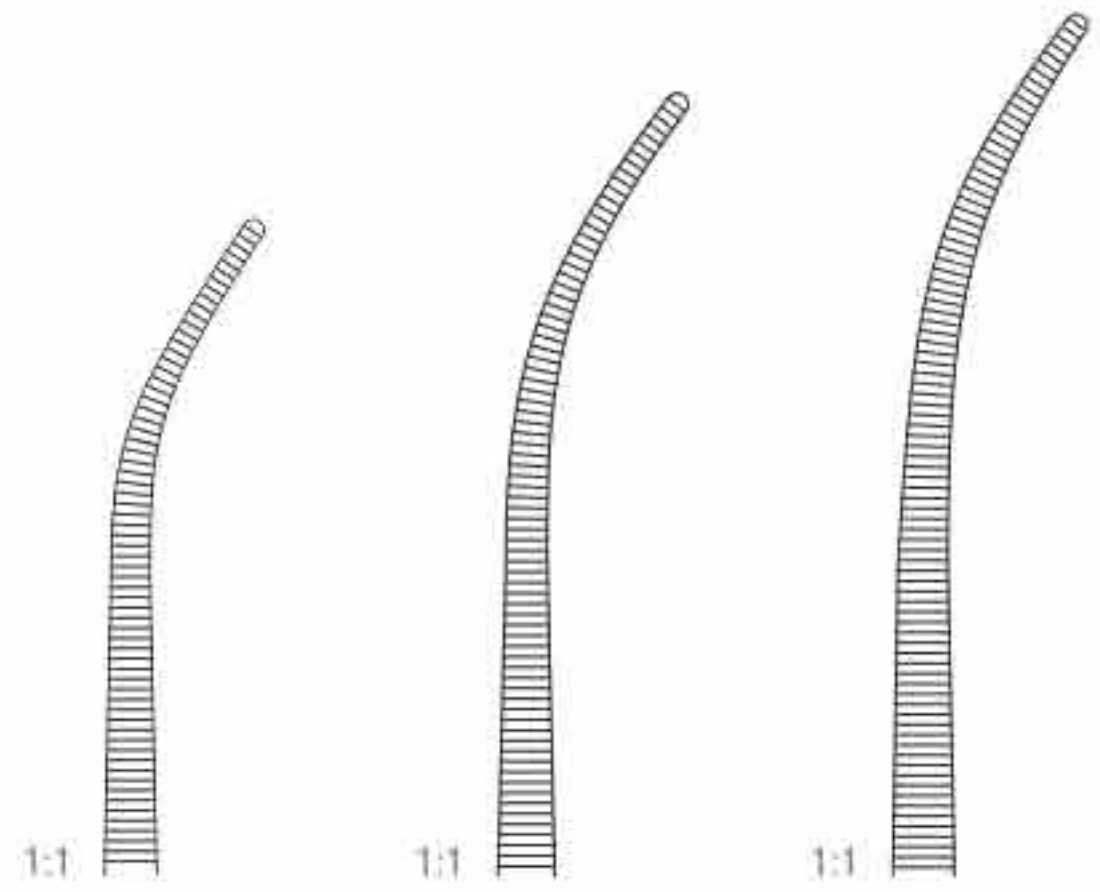
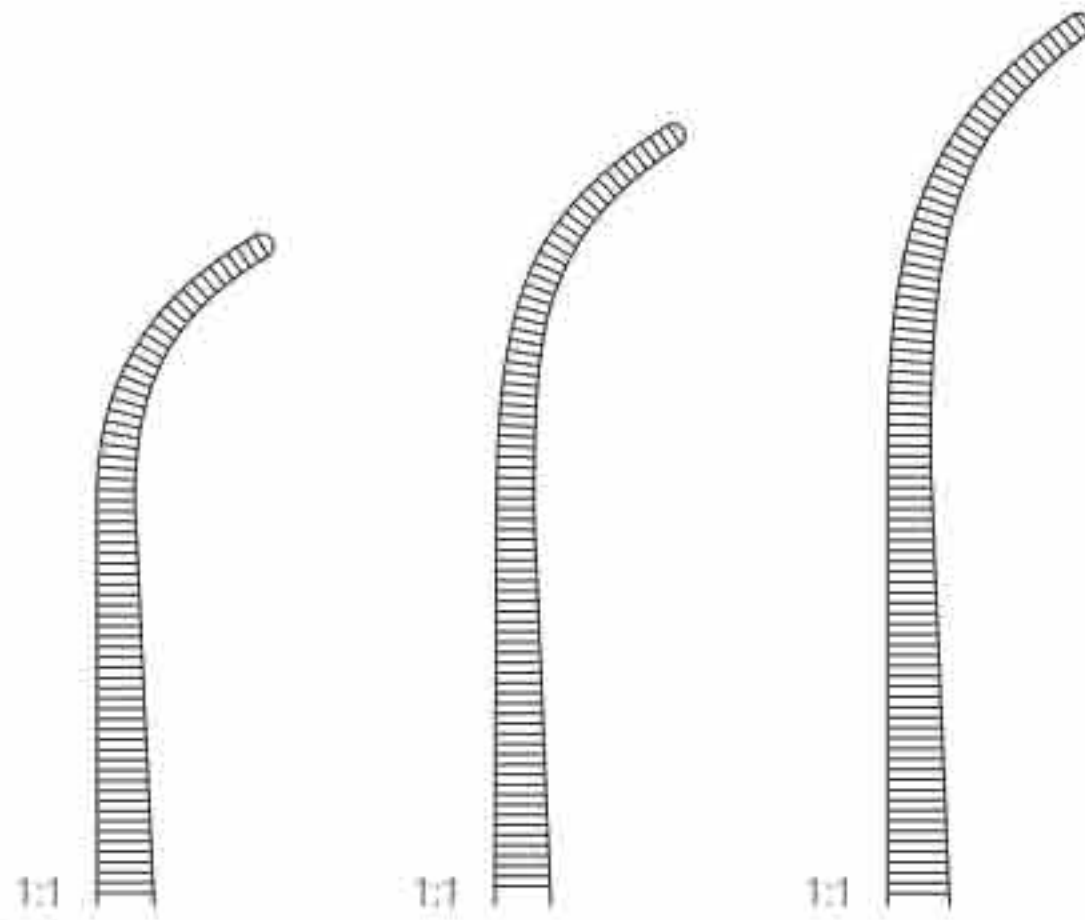

Fig. 1	Fig. 1	Fig. 1
195 mm – 7 ¾ "	225 mm – 8 ¾ "	245 mm – 9 ¾ "
01-1814	01-1815	01-1816



kelly-fraser

Fig. 2	Fig. 2	Fig. 2
190 mm – 7 ½ "	220 mm – 8 ¾ "	240 mm – 9 ½ "
01-1817	01-1818	01-1819

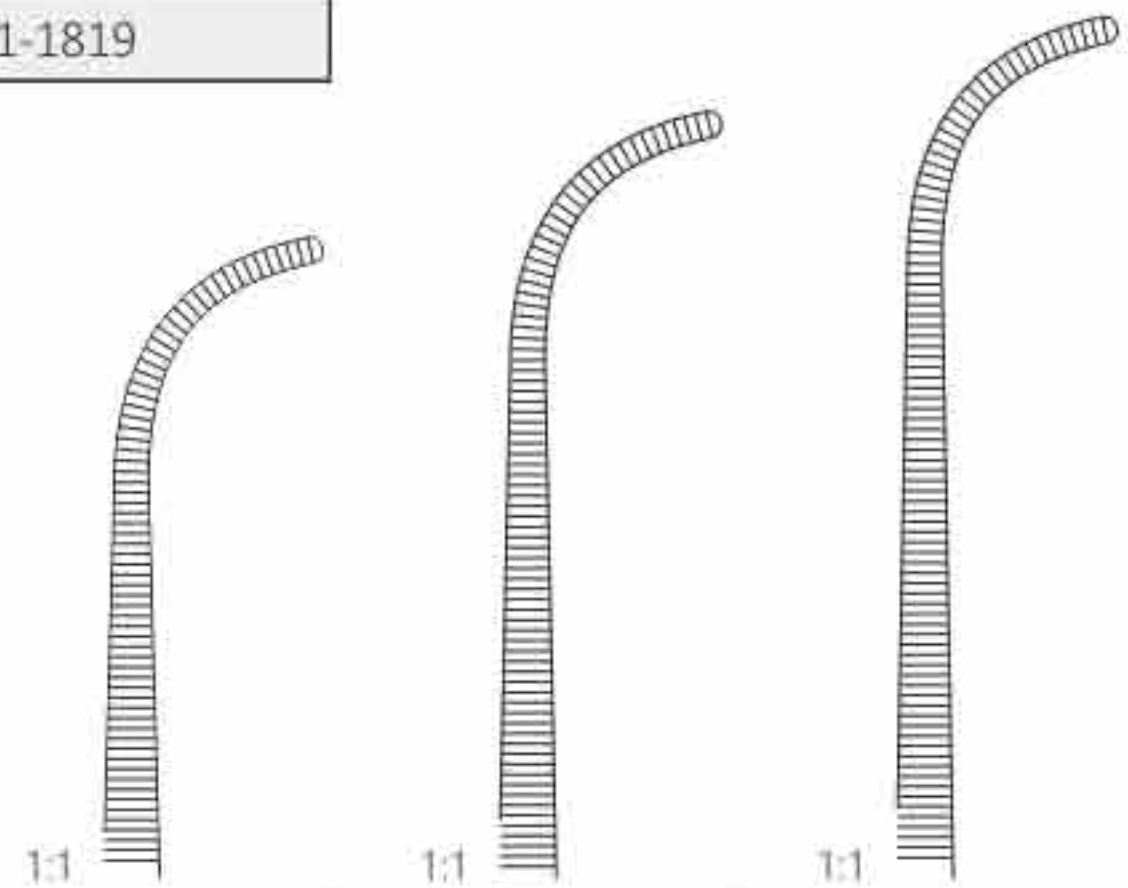

Fig. 3	Fig. 3	Fig. 3
185 mm – 7 ¼ "	215 mm – 8 ½ "	235 mm – 9 ¼ "
01-1820	01-1821	01-1822

Haemostatic forceps



schniDt

1:1

1:1

190 mm – 7 ½ "	01-1823	01-1824
----------------	---------	---------

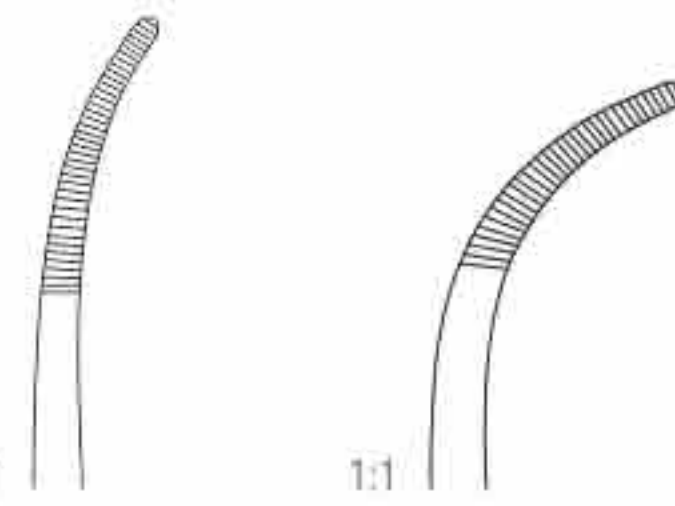

toennis

210 mm – 8 ¼ "	01-1825-01	01-1826-01	01-1827-01	01-1828-01
260 mm – 10 ¼ "	01-1825-02	01-1826-02	01-1827-02	01-1828-02

1 x 2

1 x 2

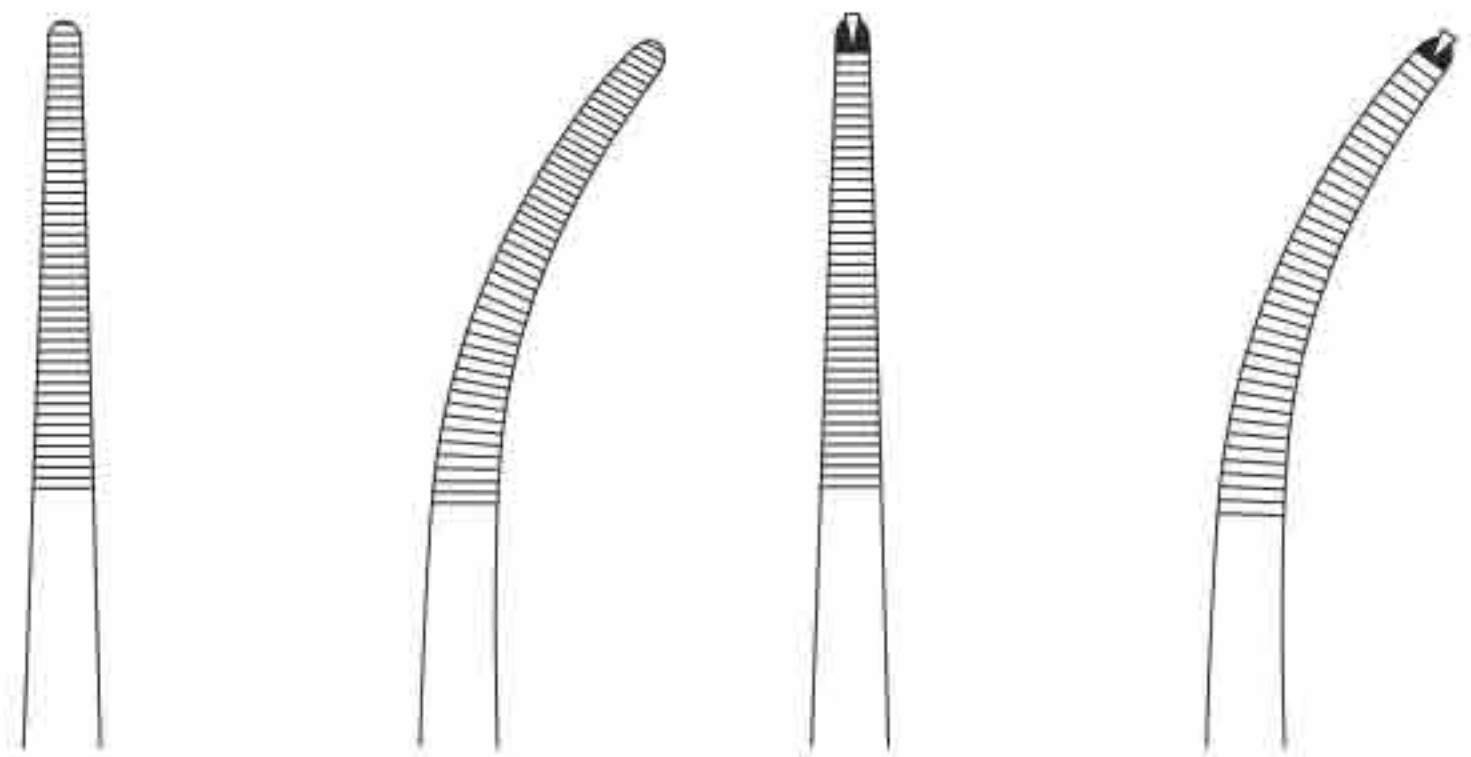

Haemostatic forceps

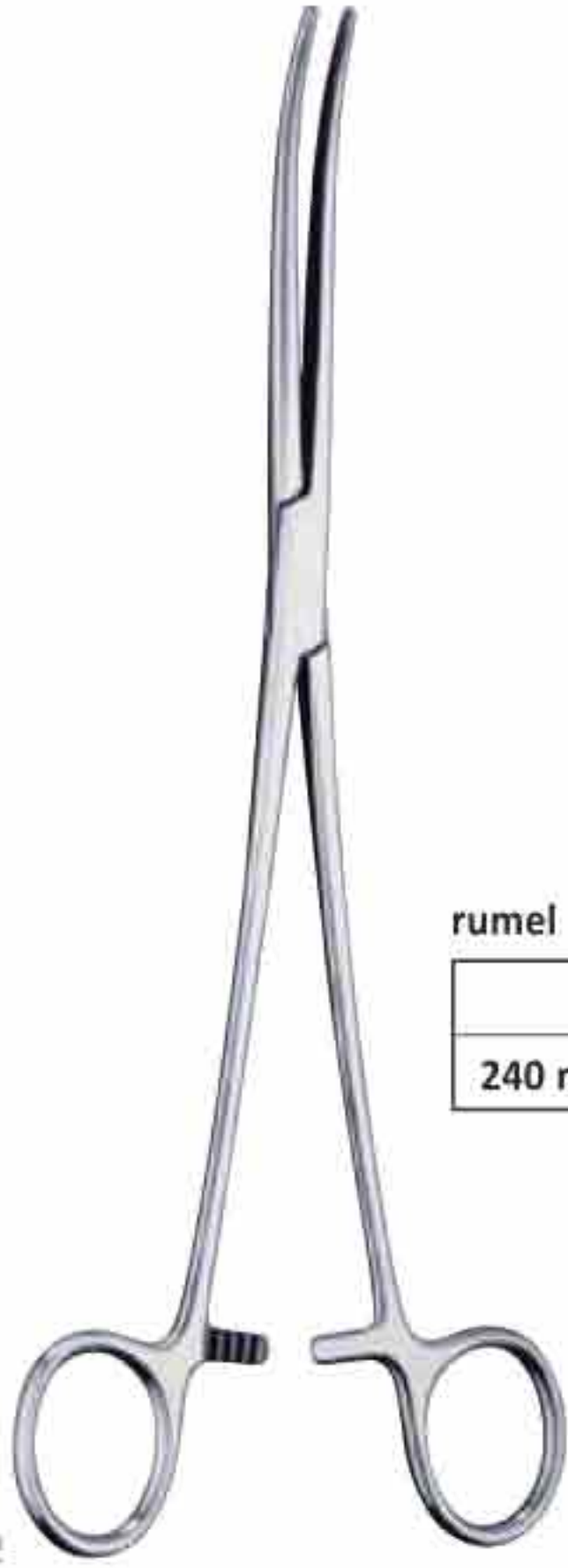

1:2

rumel

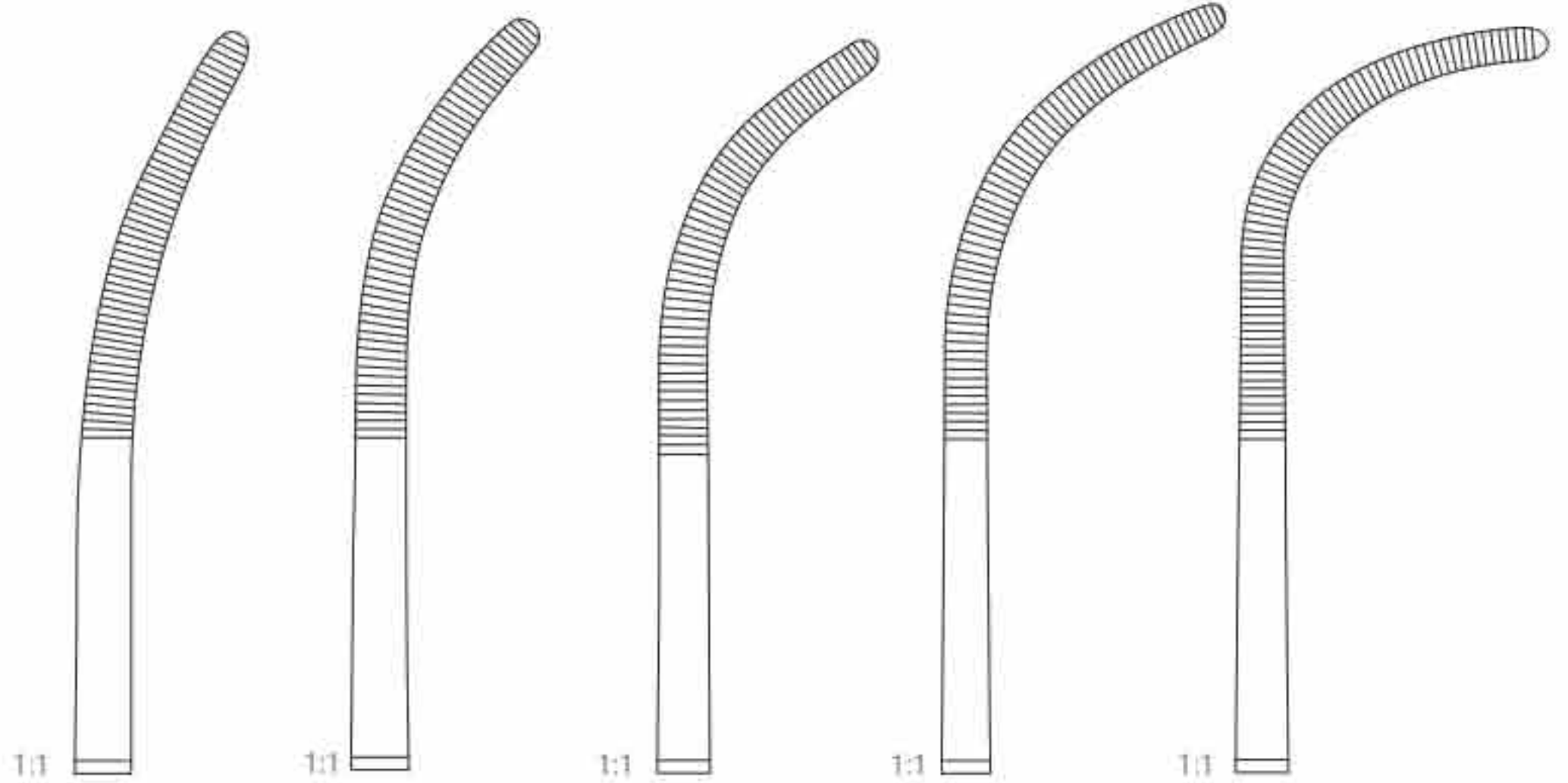

	Fig. 1	Fig. 2	Fig. 3	Fig. 4	Fig. 5
240 mm – 9 ½"	01-1829	01-1830	01-1831	01-1832	01-1833



meeker

180 mm – 7"	01-1834-01
275 mm – 10 ¾"	01-1834-02

curved, 90°

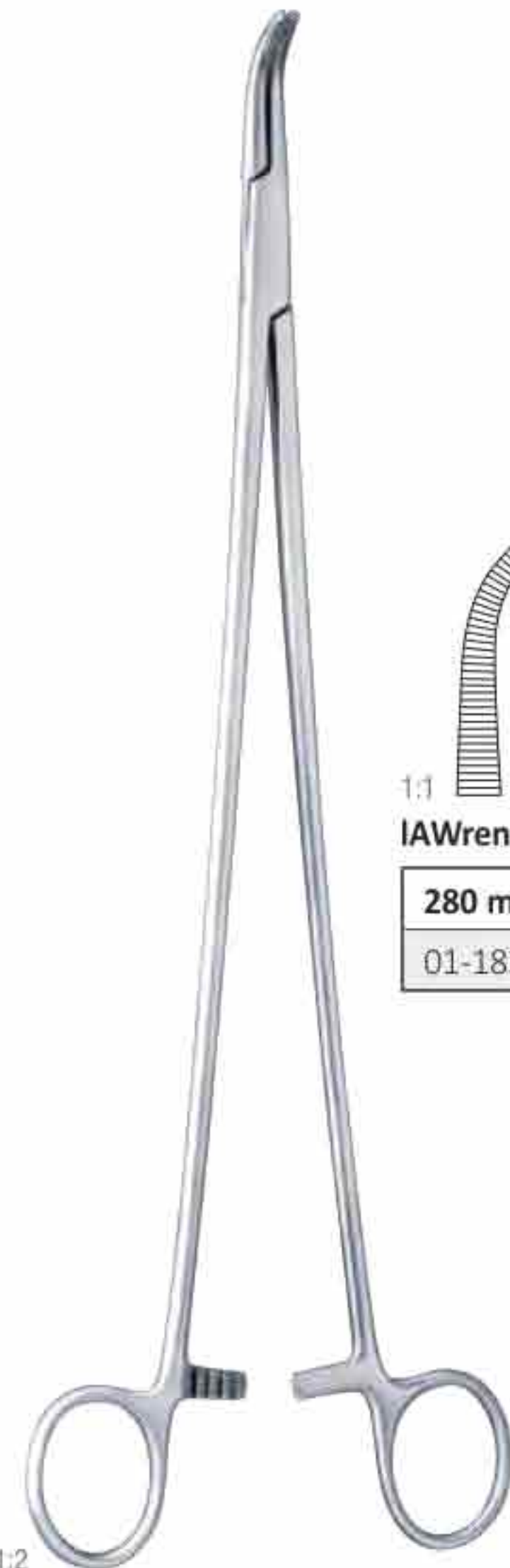

1:2

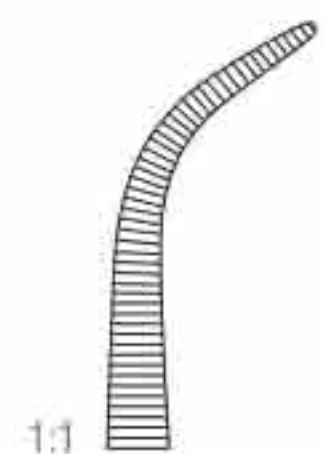

IAWrence

280 mm – 11"
01-1835

Dissecting and ligature forceps



overholt-
GeissenDoerfer

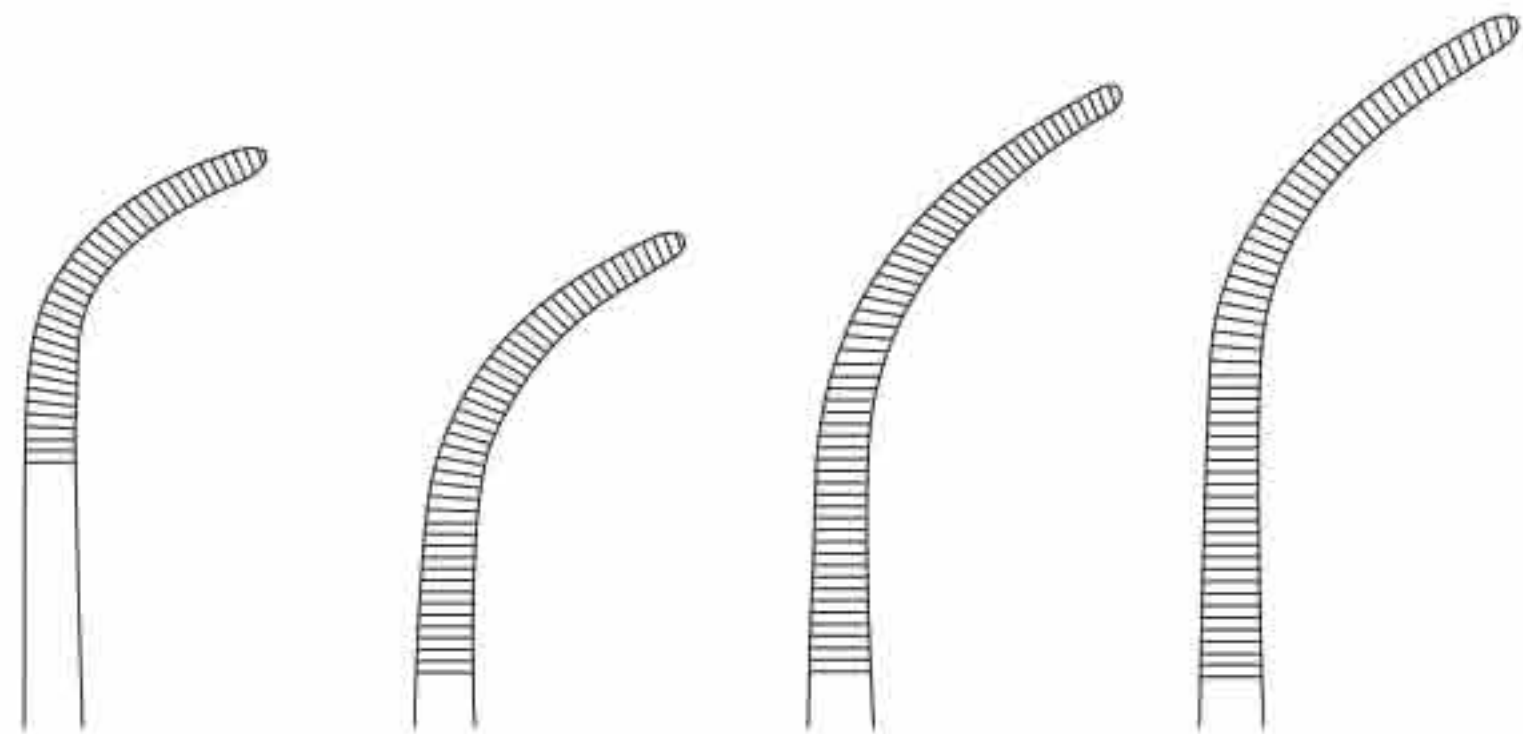

	Fig. 1	Fig. 2	Fig. 3	Fig. 4
210 mm – 8 ¼ "	01-1836-01	01-1837-01	01-1838-01	01-1839-01
270 mm – 10 ¾ "	01-1836-02	01-1837-02	01-1838-02	01-1839-02

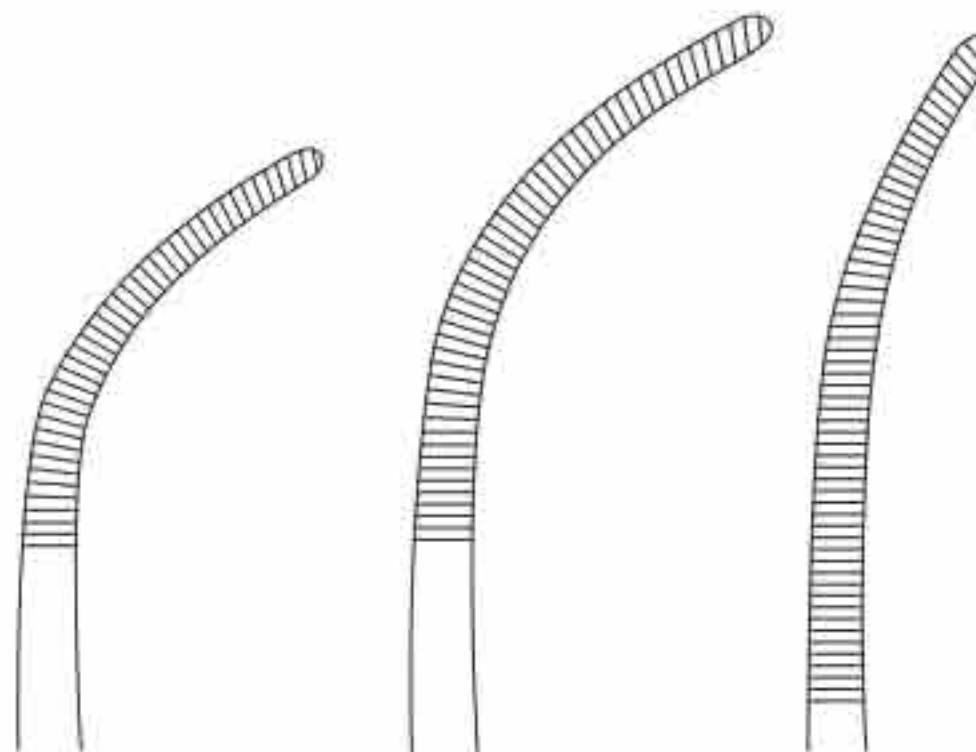
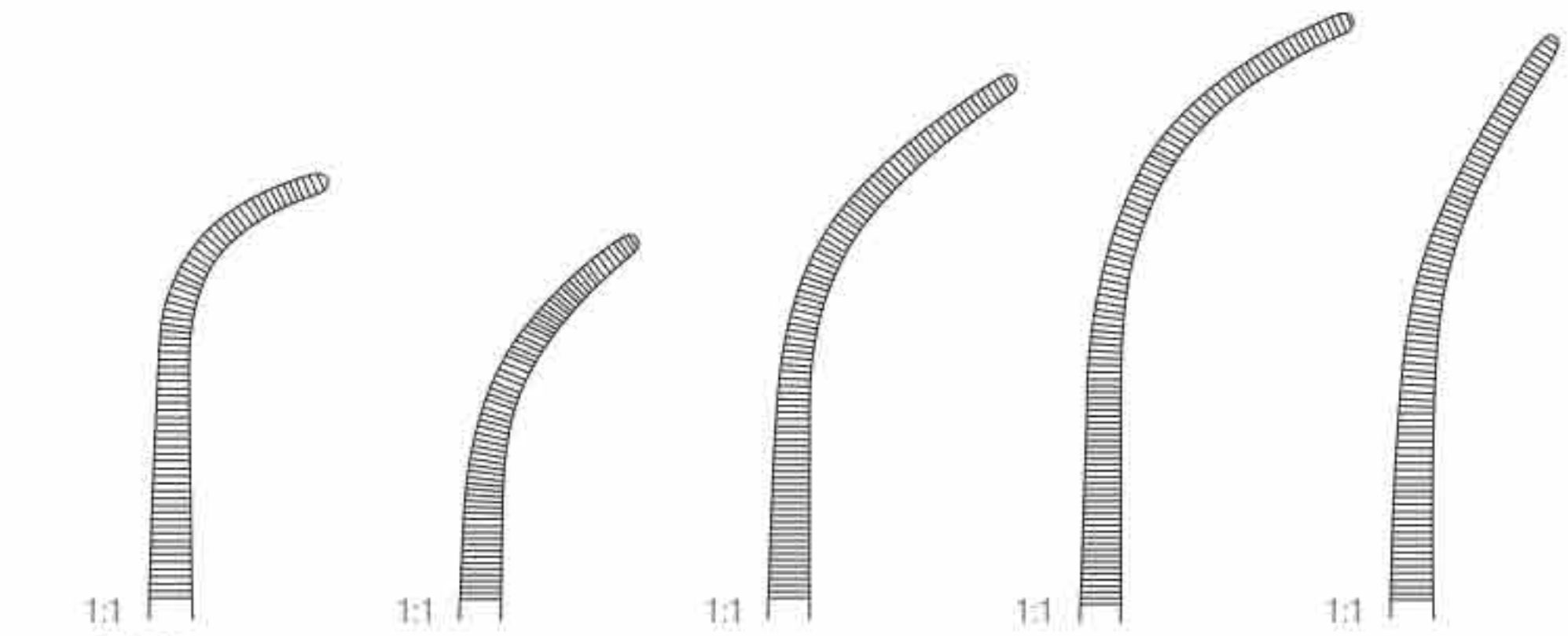

	Fig. 5	Fig. 6	Fig. 7
210 mm – 8 ¼ "	01-1840-01	01-1841-01	01-1842-01
270 mm – 10 ¾ "	01-1840-02	01-1841-02	01-1842-02

Dissecting and ligature forceps



overholt-fino

Fig. 0	Fig. 1	Fig. 2	Fig. 3	Fig. 6
215 mm – 8 ½ "	210 mm – 8 ¼ "	220 mm – 8 ¾ "	230 mm – 9 "	225 mm – 8 ¾ "
01-1843	01-1844	01-1845	01-1846	01-1847

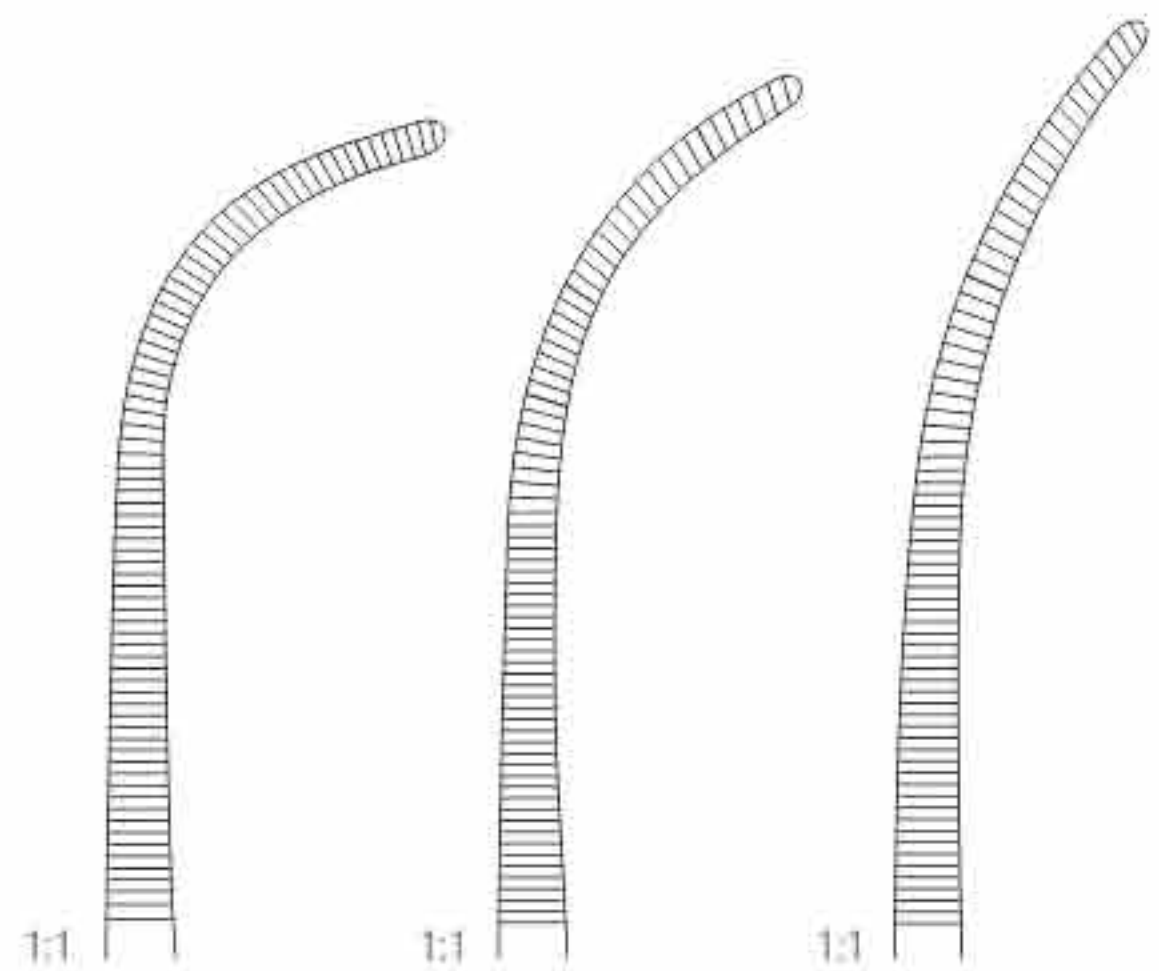

overholt

Fig. 0	Fig. 1	Fig. 6
295 mm – 8 ½ "	295 mm – 8 ½ "	300 mm – 8 ¾ "
01-1848	01-1849	01-1850

Dissecting and ligature forceps

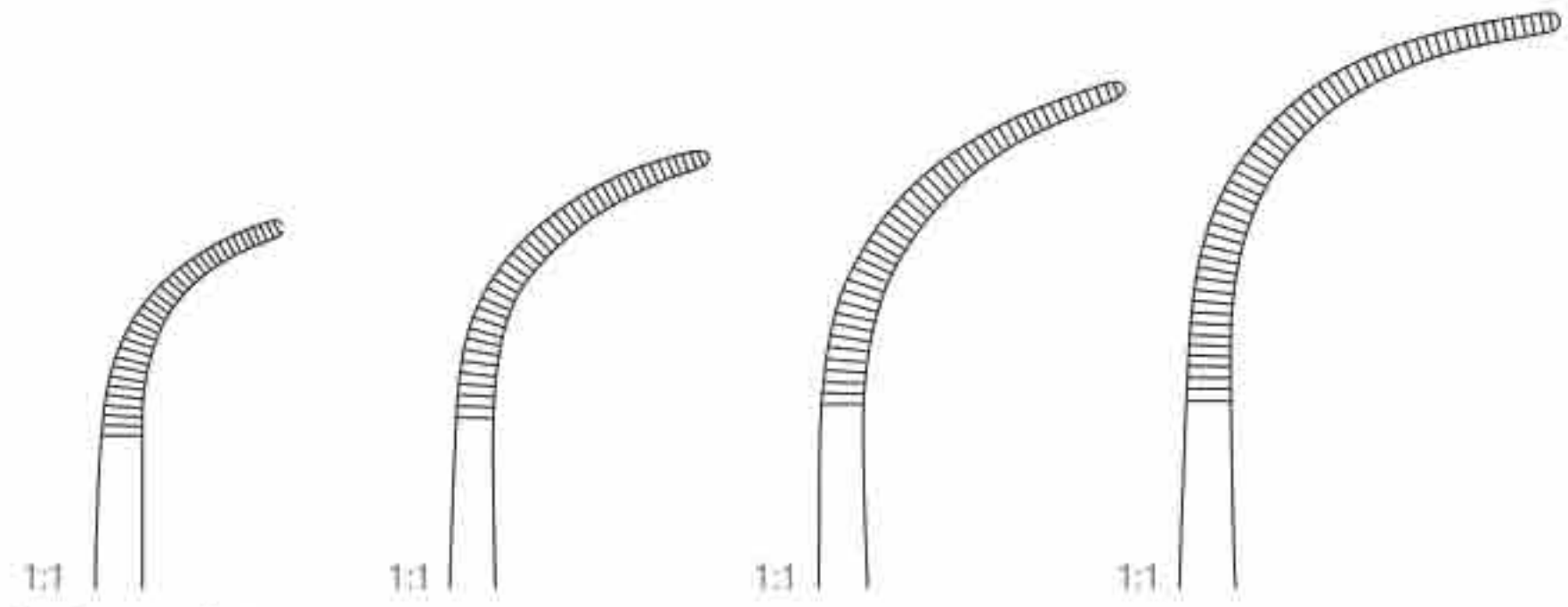

overholt-modifiziert

185 mm – 7 ¼ "	205 mm – 8 "	210 mm – 8 ¼ "	215 mm – 8 ½ "
01-1851	01-1852	01-1853	01-1854

S-curved



overholt-mixer

210 mm – 8 ¼ "	01-1855
----------------	---------

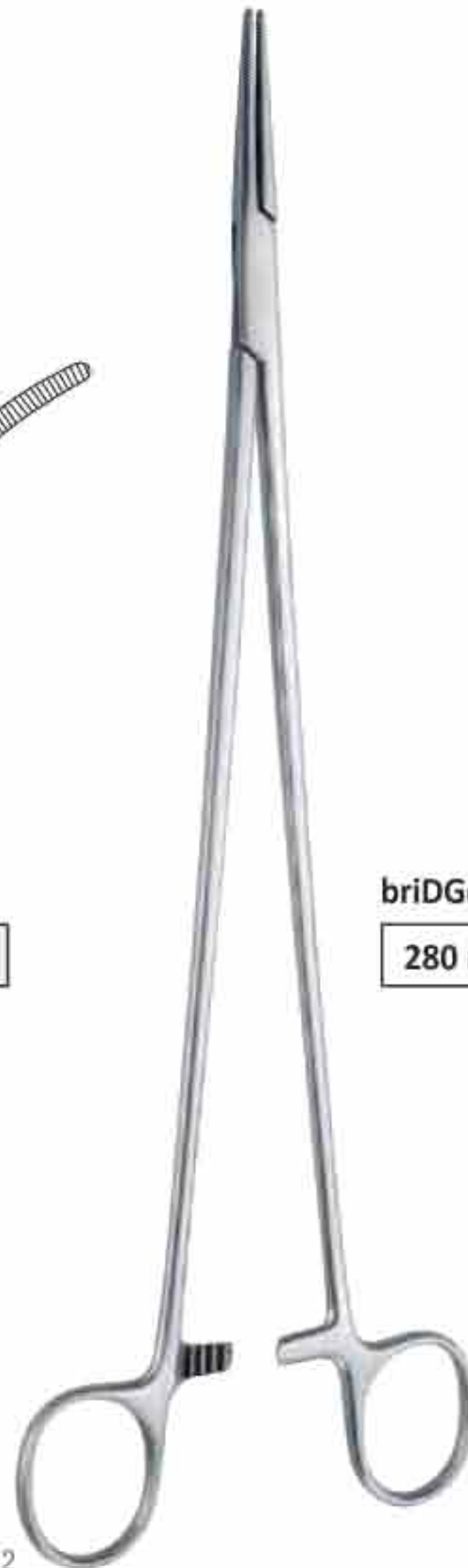
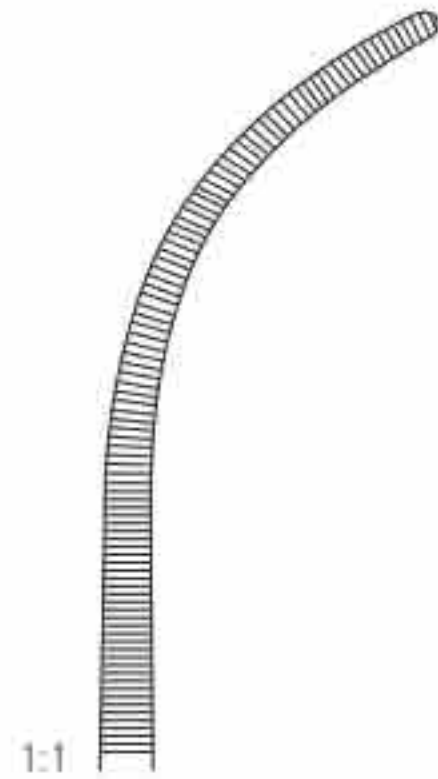

briDGe

280 mm – 11 "	01-1856-01	01-1856-02
---------------	------------	------------

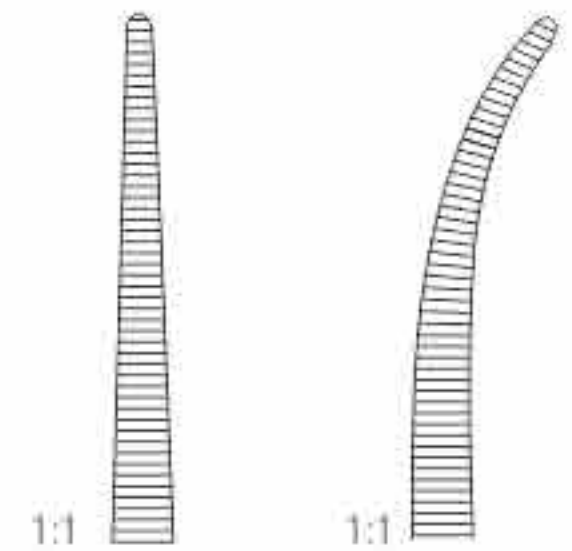

Dissecting and ligature forceps

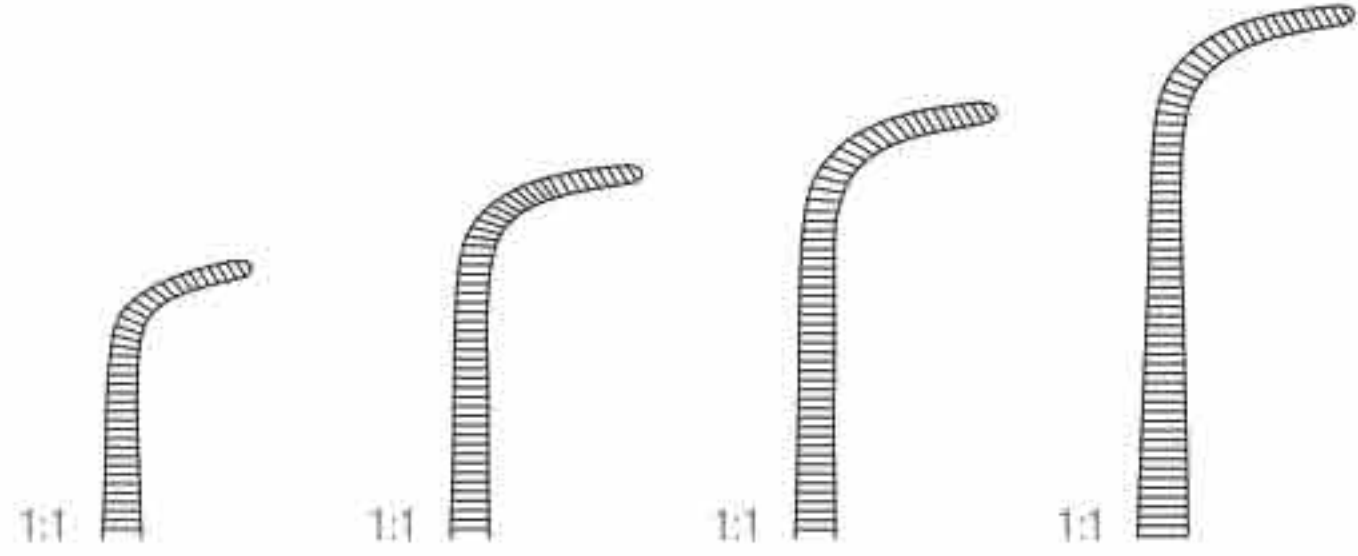

Gemini

130 mm – 5 "	160 mm – 6 ¼ "	180 mm – 7 "	200 mm – 8 "
01-1857	01-1858	01-1859	01-1860

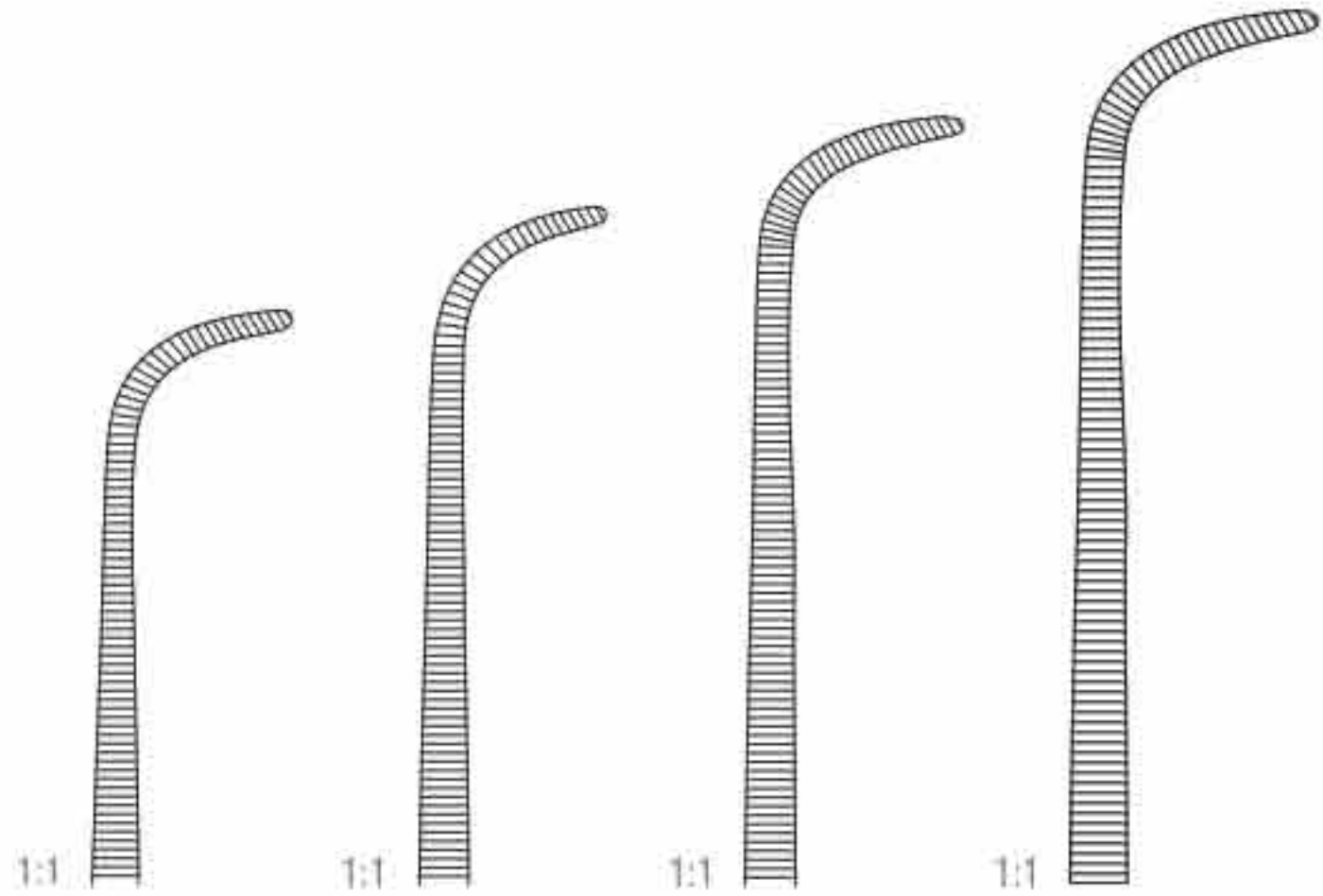

230 mm – 9 "	250 mm – 9 ¾ "	280 mm – 11 "	350 mm – 14 "
01-1861	01-1862	01-1863	01-1864

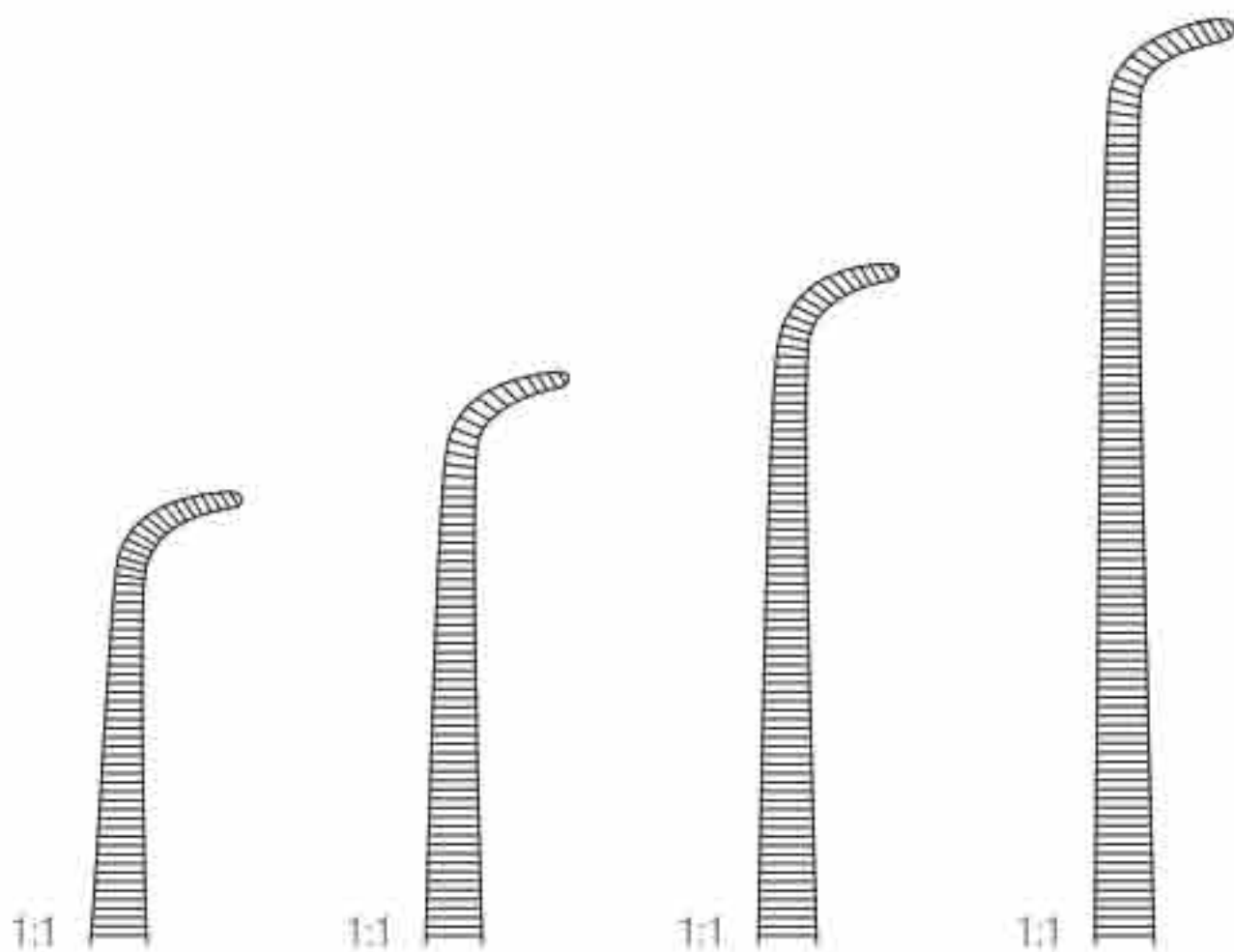

Gemini-mini

180 mm – 7 "	220 mm – 8 ¾ "	250 mm – 9 ¾ "	280 mm – 11 "
01-1865	01-1866	01-1867	01-1868

Dissecting and ligature forceps



zenker

295 mm – 11 ½ "

1:1

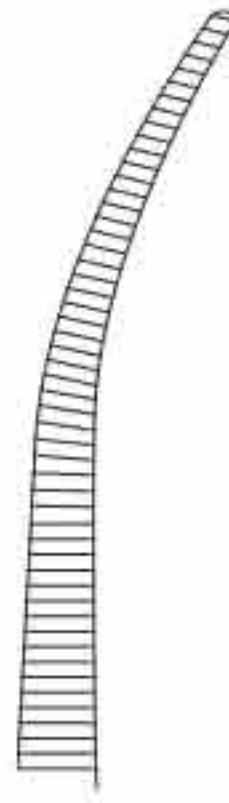

1:1

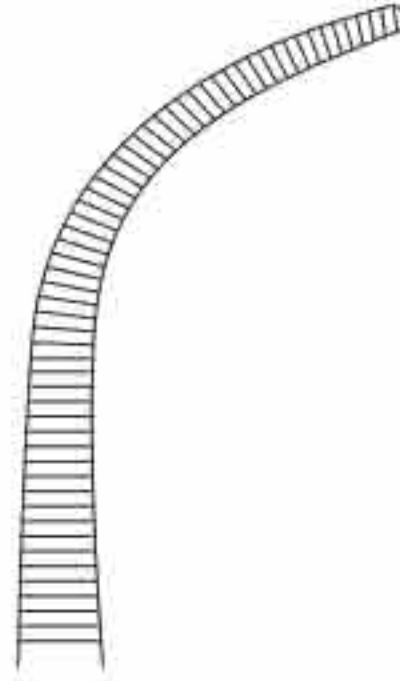

01-1869-01 01-1869-02



roberts

220 mm – 8 ¾ "

1:1



1:1



01-1870-01 01-1870-02

Dissecting and ligature forceps



mixter

140 mm – 6"	01-1871-01
155 mm – 6"	01-1871-02
190 mm – 7 ½"	01-1871-03
230 mm – 9"	01-1871-04

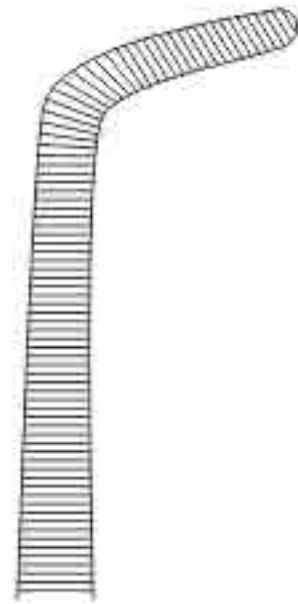

kAntroWitz

190 mm – 7 ½"	01-1872-01
240 mm – 9 ½"	01-1871-02
265 mm – 10 ½"	01-1871-03

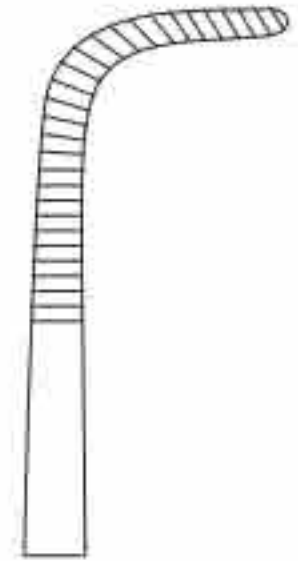

mixter

230 mm – 9"	01-1873
-------------	---------

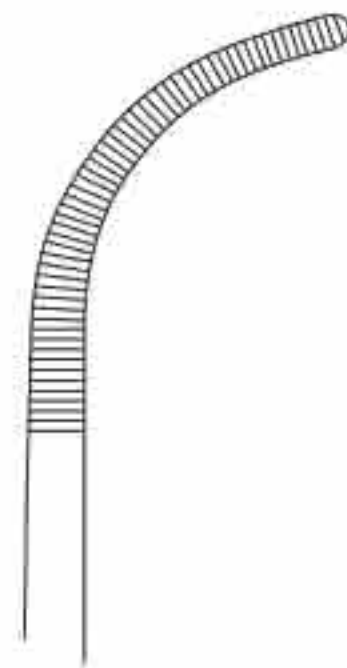

1:2

Dissecting and ligature forceps



mixer

230 mm – 9"	01-1874
-------------	---------

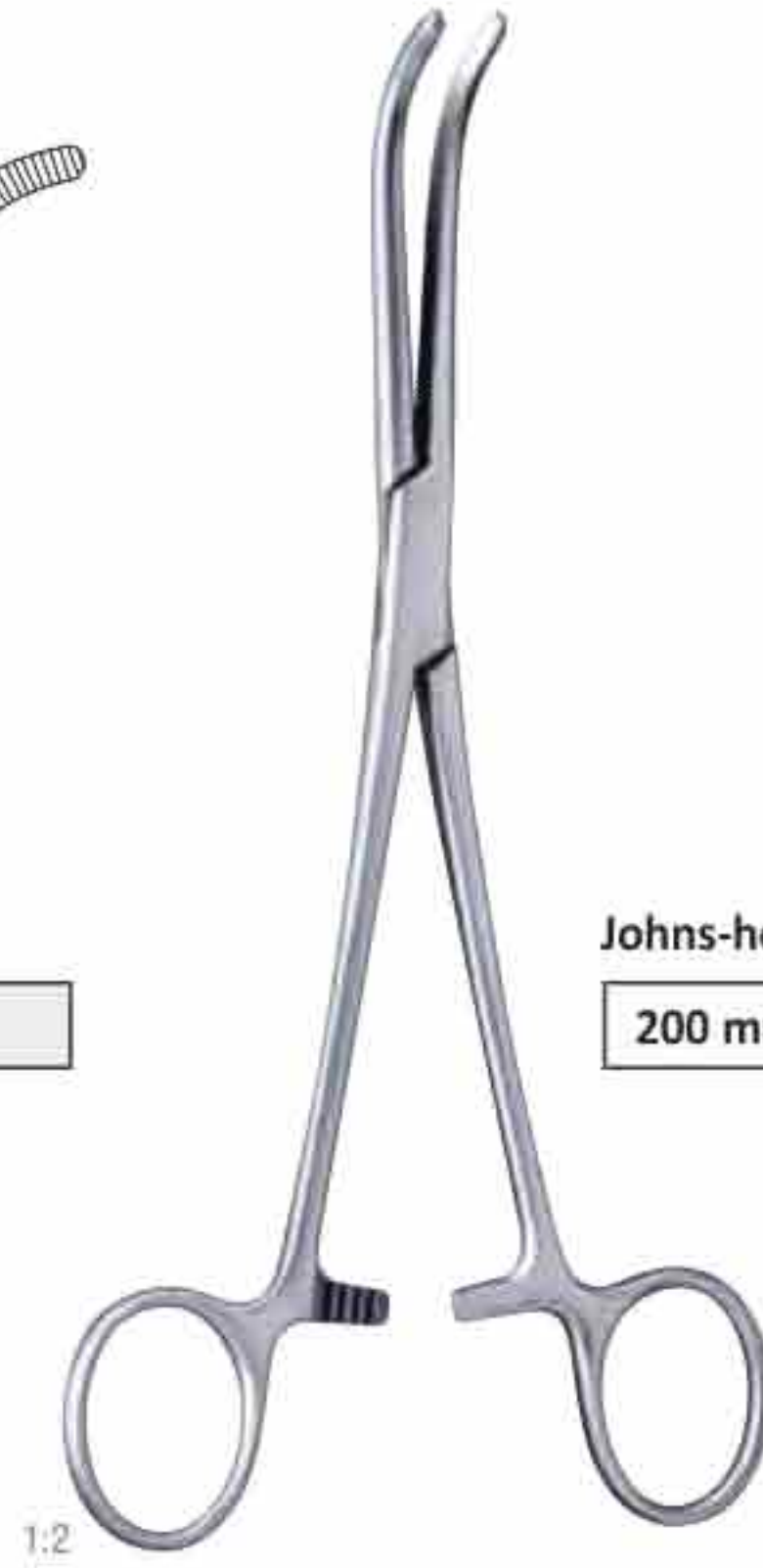
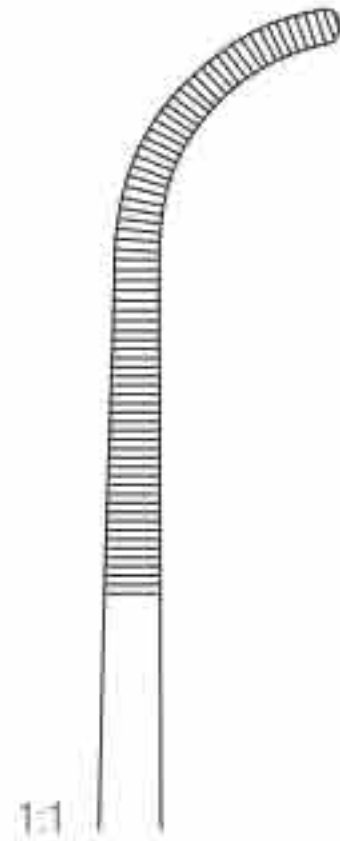

Johns-hopkins

200 mm – 8"	01-1875
-------------	---------

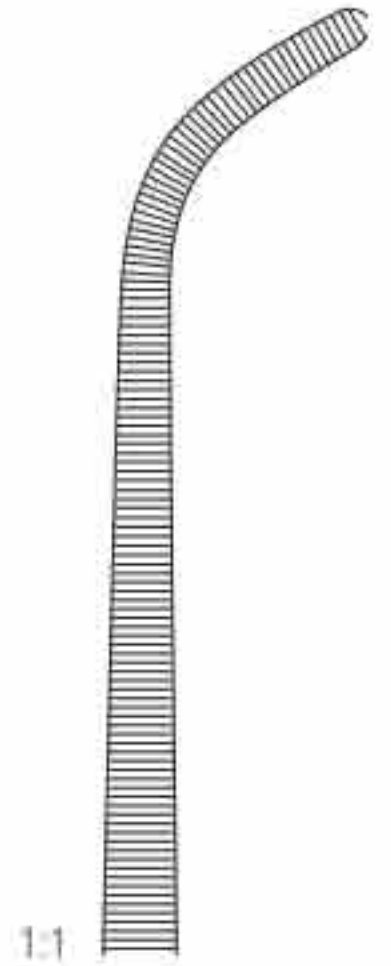

mixer-o'shAuGnessY

155 mm – 6"	01-1876-01
190 mm – 7 ½"	01-1876-02

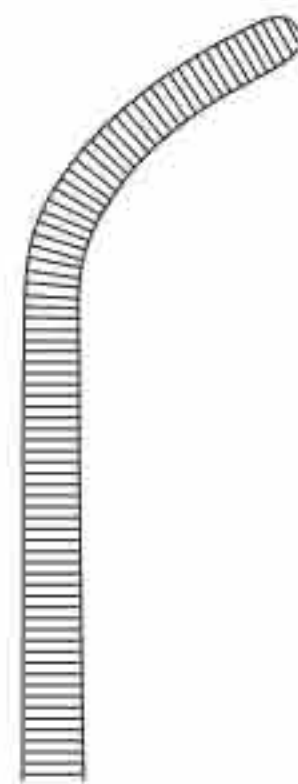

Dissecting and ligature forceps



Wickström

210 mm – 8 ¼ "	01-1877-01
240 mm – 9 ½ "	01-1877-02

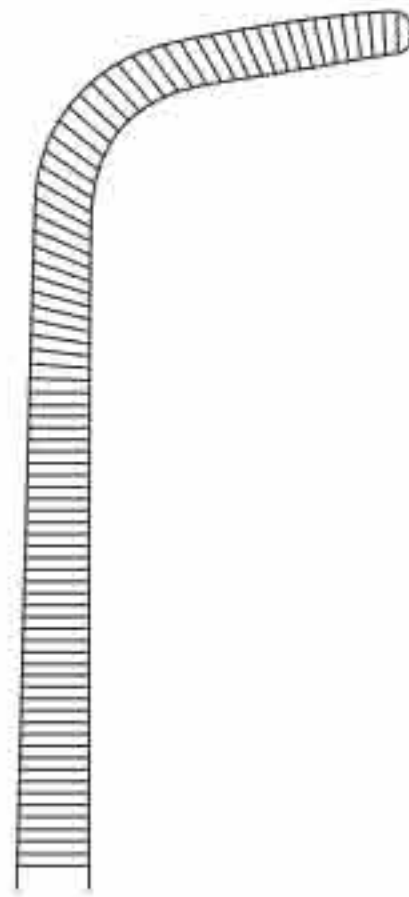

crAfoorD

180 mm – 7 "	01-1878-01
240 mm – 9 ½ "	01-1878-02

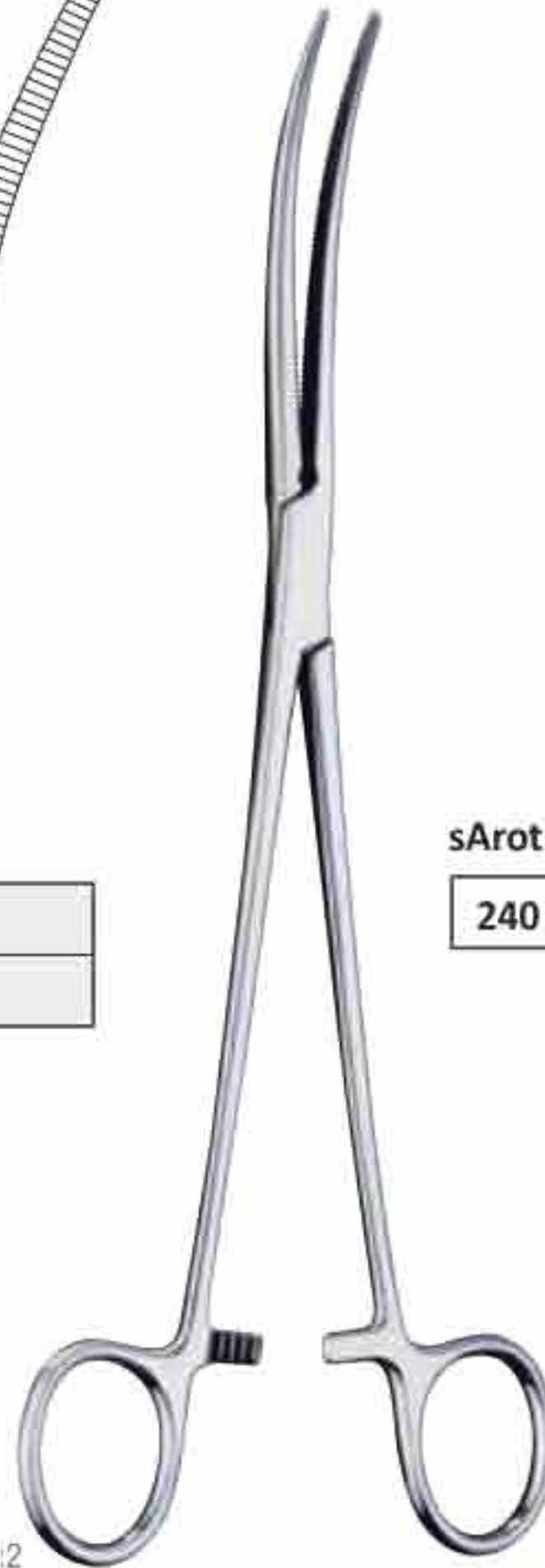
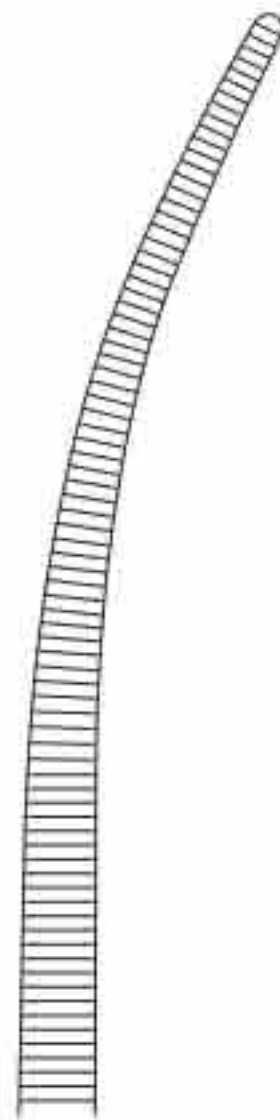

sArot

240 mm – 9 ½ "	01-1879-01	01-1879-02
----------------	------------	------------

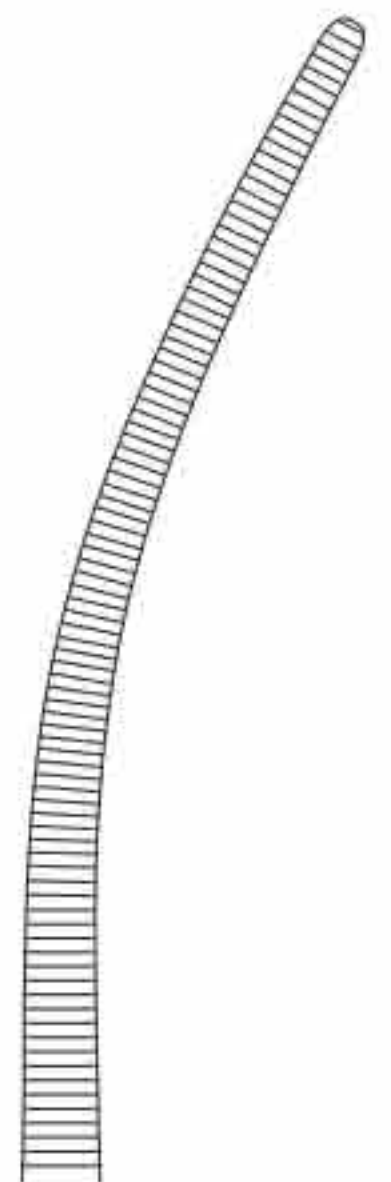

1:2

Dissecting and ligature forceps

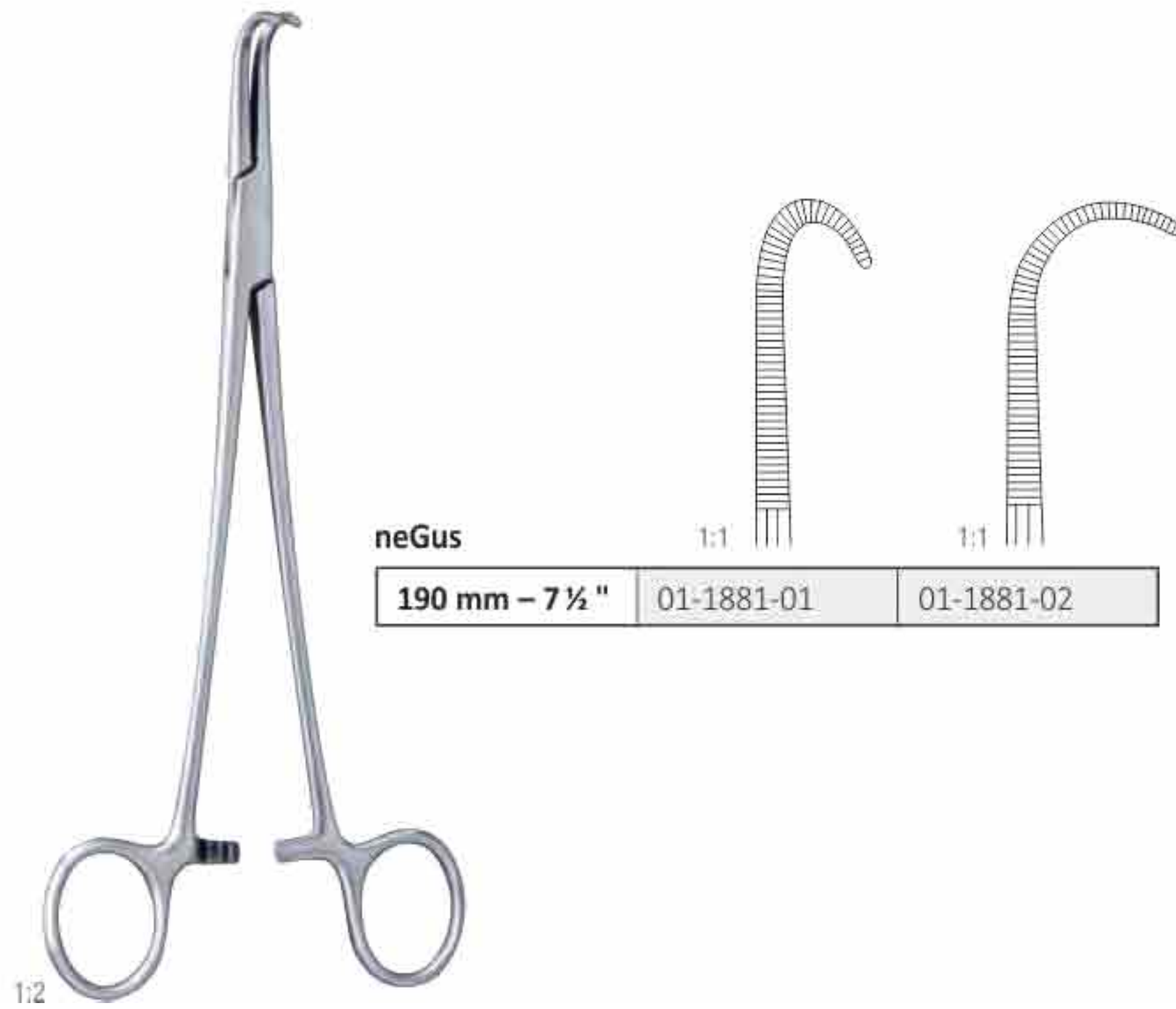

Kidney pedicle and gall duct forceps

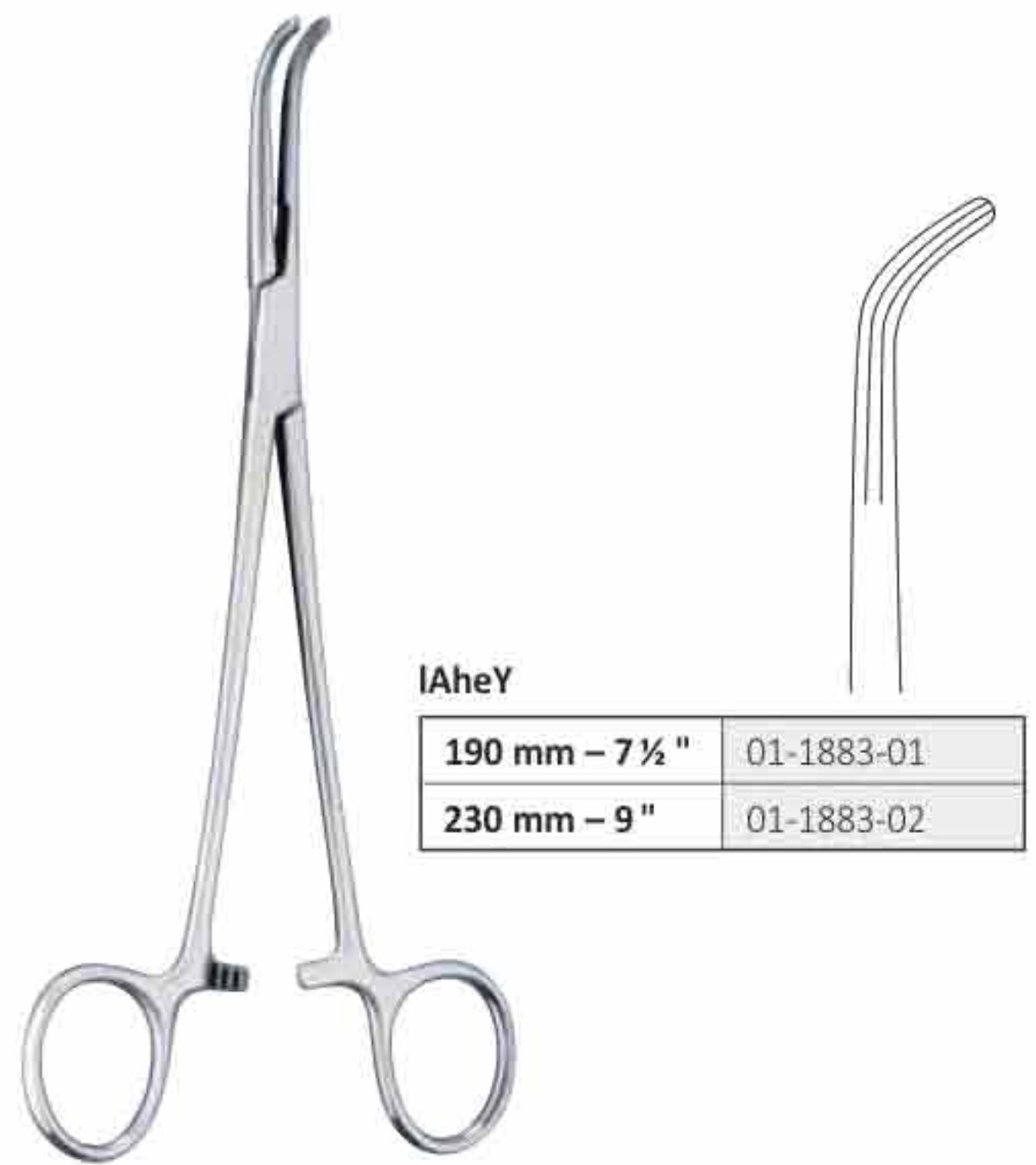
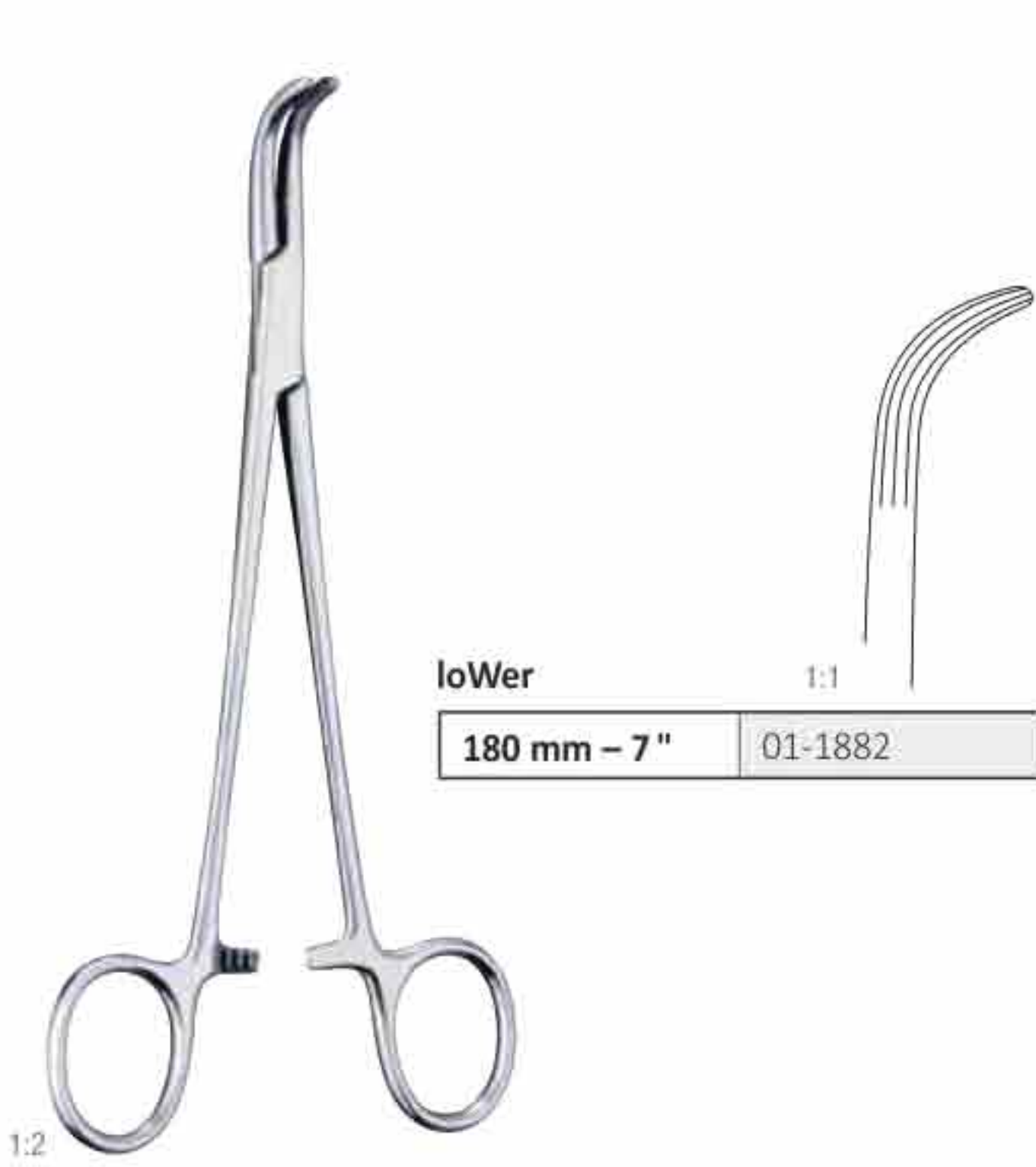

Kidney pedicle and gall duct forceps



finochietto 1:1

240 mm – 9 ½ "	01-1885
----------------	---------

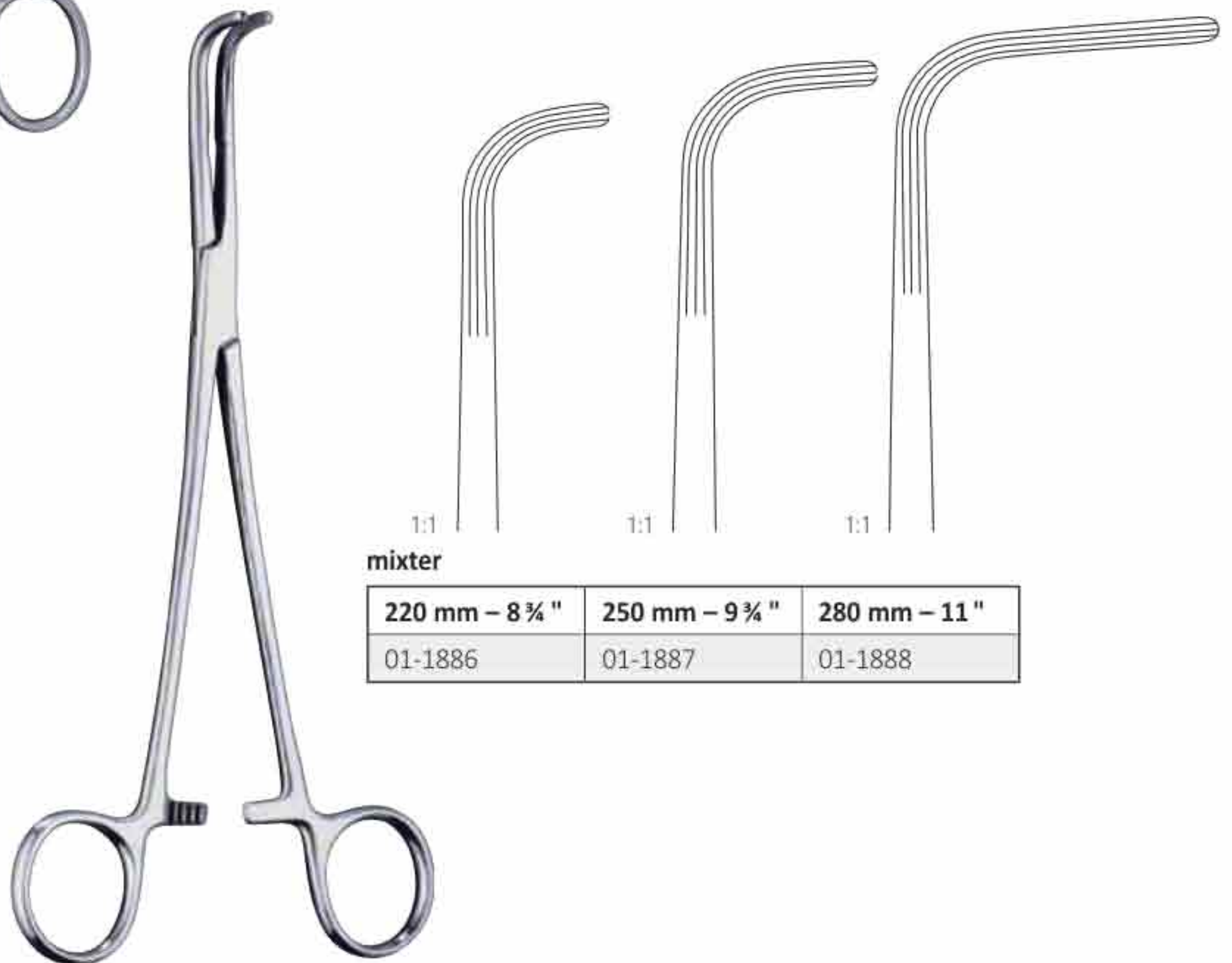

mixter 1:1 1:1 1:1

220 mm – 8 ¾ "	250 mm – 9 ¾ "	280 mm – 11 "
01-1886	01-1887	01-1888

Kidney pedicle and gall duct forceps

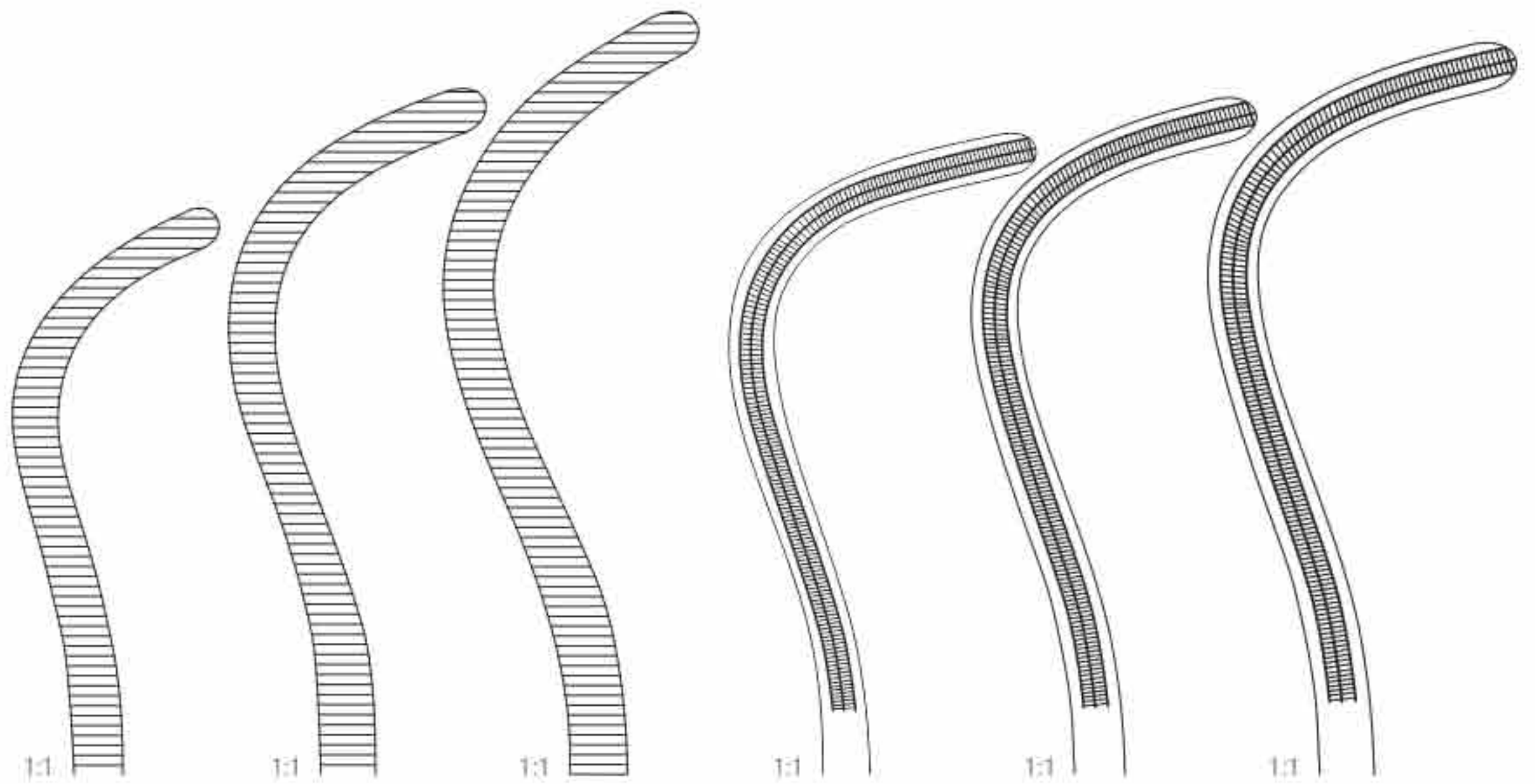

GuYon

			Atrauma	Atrauma	Atrauma
200 mm – 8"	220 mm – 8 ¼"	240 mm – 9 ½"	225 mm – 9"	230 mm – 9"	240 mm – 9 ½"
01-1889	01-1890	01-1891	01-1892	01-1893	01-1894



herrick

230 mm – 9"	01-1895
-------------	---------



GuYon

230 mm – 9"	01-1896
-------------	---------

1:2

Clamp forceps – Kidney pedicle
Peritoneal forceps

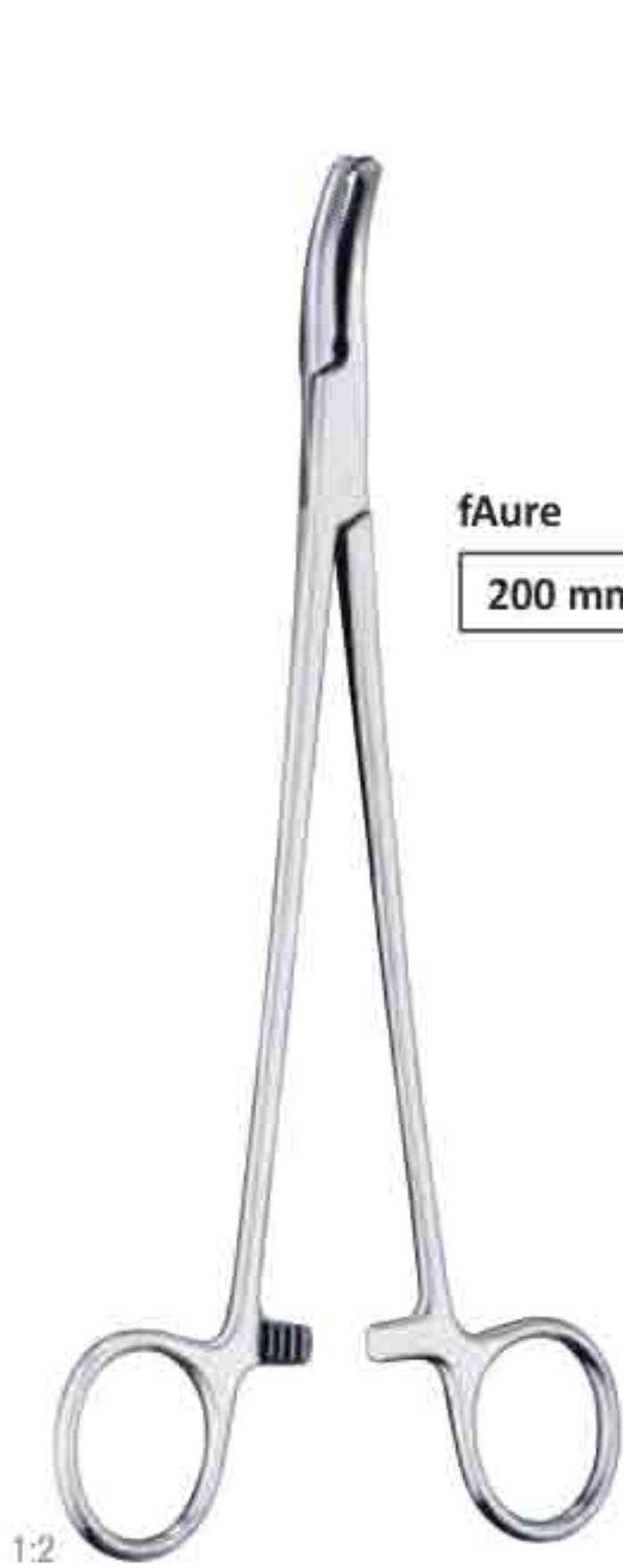

fAure

200 mm – 8"	01-1897-01	01-1897-02
	1 x 2	1 x 2

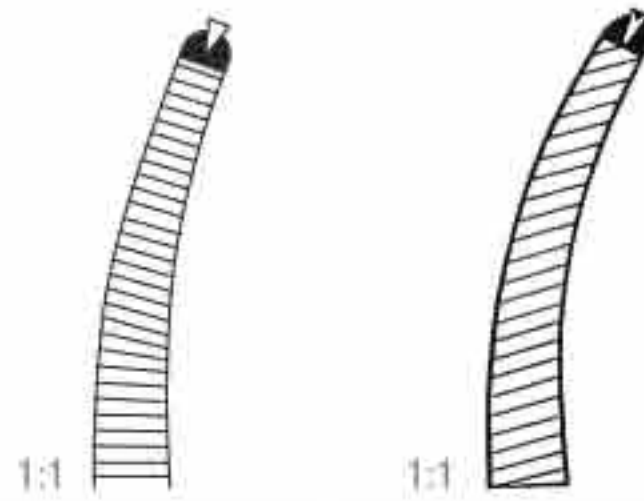

Wertheim

220 mm – 8 3/4"	01-1898
230 mm – 9"	01-1899
	1 x 2

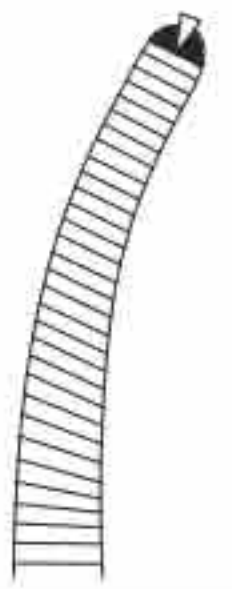

mAYo-GuYon

230 mm – 9"	01-1900
-------------	---------

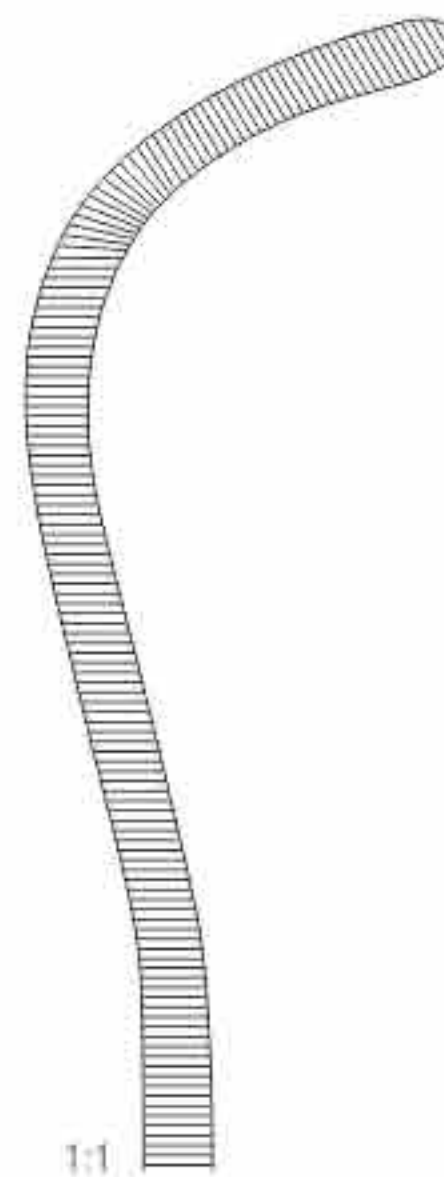

Clamp forceps – Peritoneal forceps



phAneuf

215 mm – 8 ½ "	01-1901-01	01-1901-02
----------------	------------	------------

1 x 2

1 x 2



moYnihAn

230 mm – 9 "	240 mm – 9 ½ "
01-1902	01-1903

Clamp forceps – Peritoneal forceps

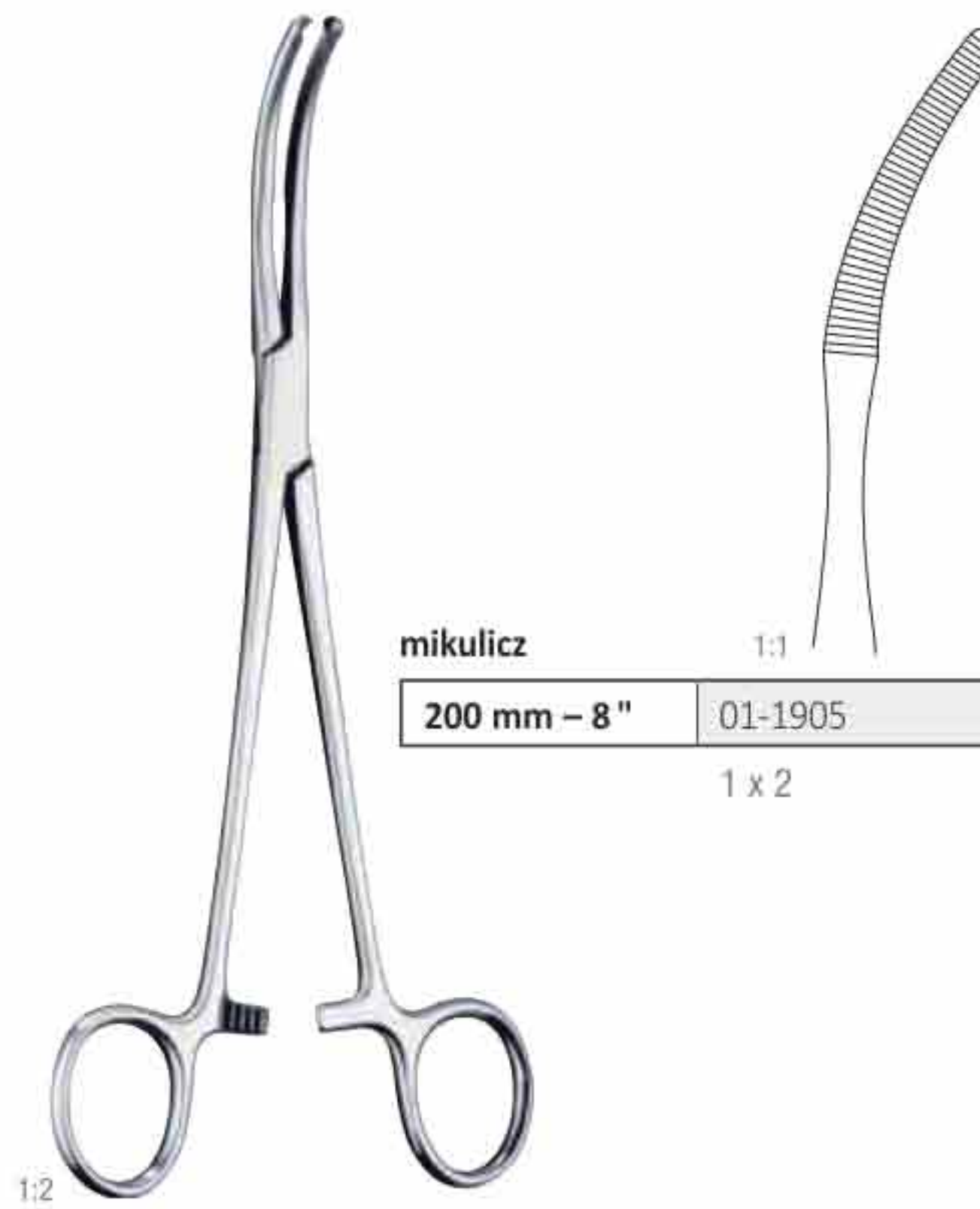

Clamp forceps – Peritoneal forceps



mAinGot

205 mm – 8"	01-1906-01
250 mm – 9 3/4"	01-1906-02

1 x 2

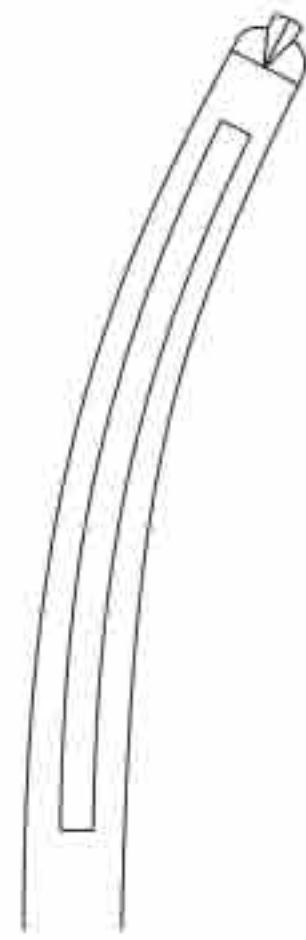

Wertheim

250 mm – 9 3/4"	01-1907
-----------------	---------

1:1

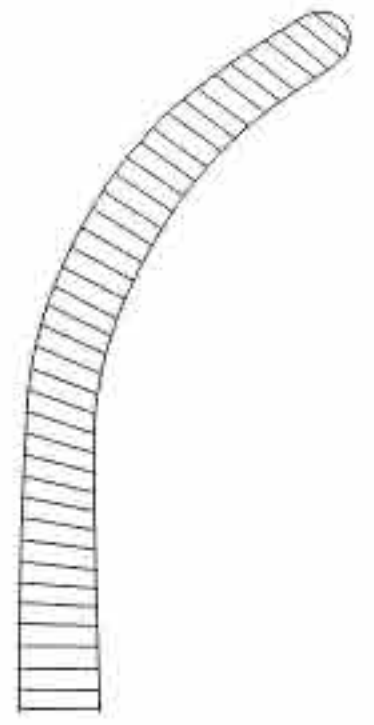

1:2

1:1

Wertheim-cullen

215 mm – 8 1/2"	01-1908
-----------------	---------

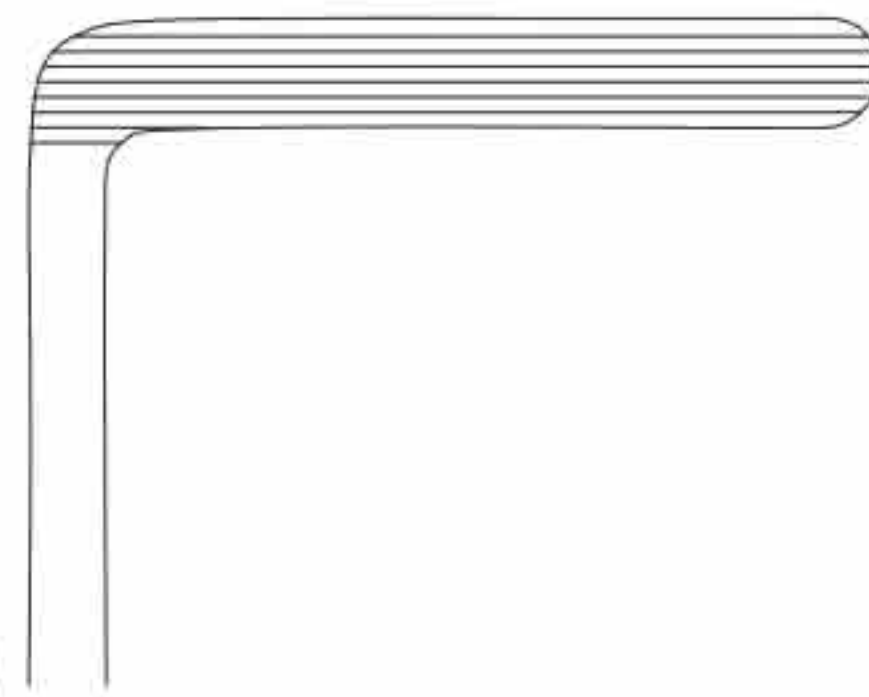

Hysterectomy forceps



HEANEY

195 mm – 7 ¾ "	01-1909-01	01-1910-01
210 mm – 8 ¼ "	01-1909-02	01-1910-02
230 mm – 9 "	01-1909-03	01-1910-03

Hysterectomy forceps

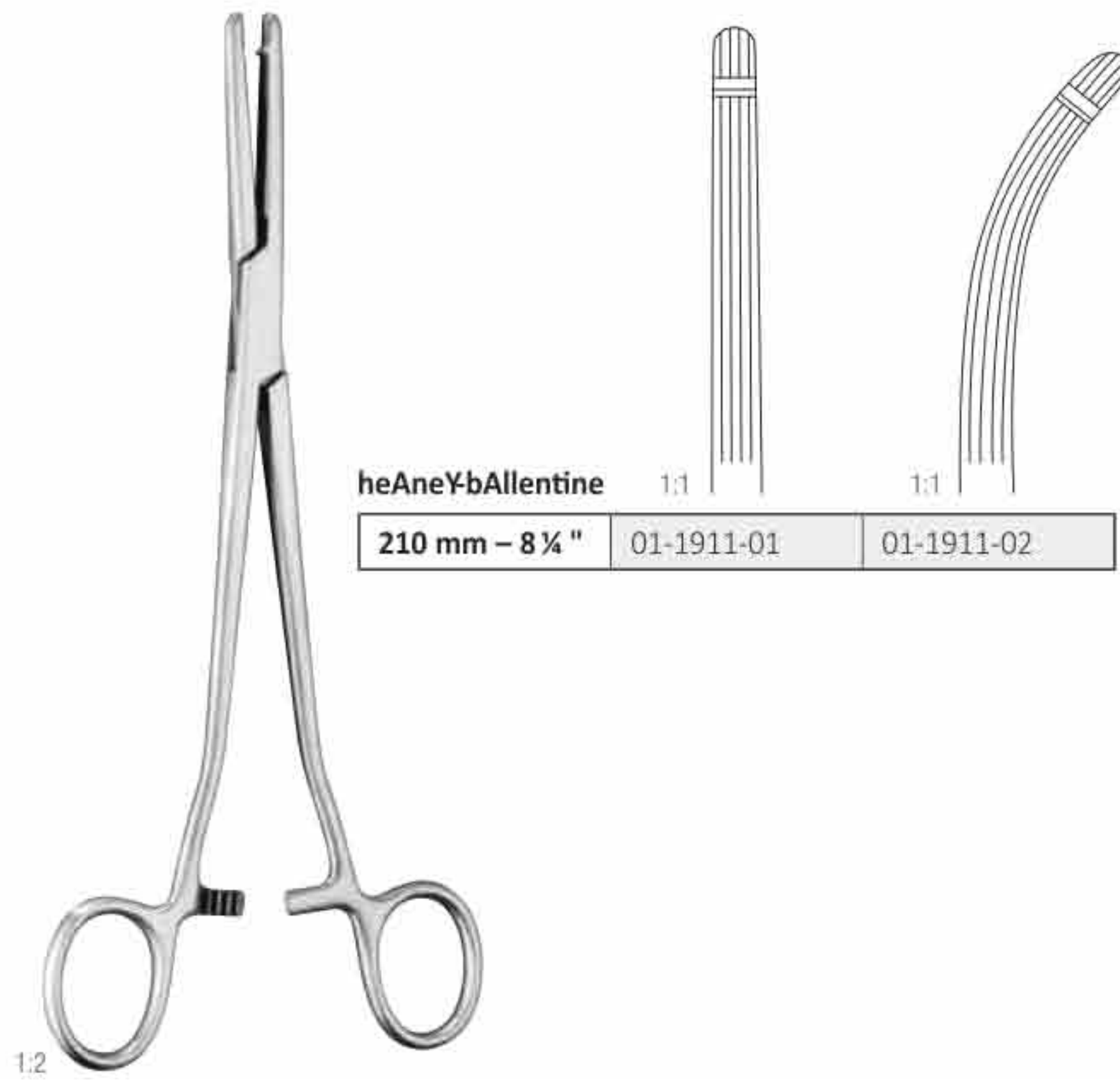

Parametrium forceps

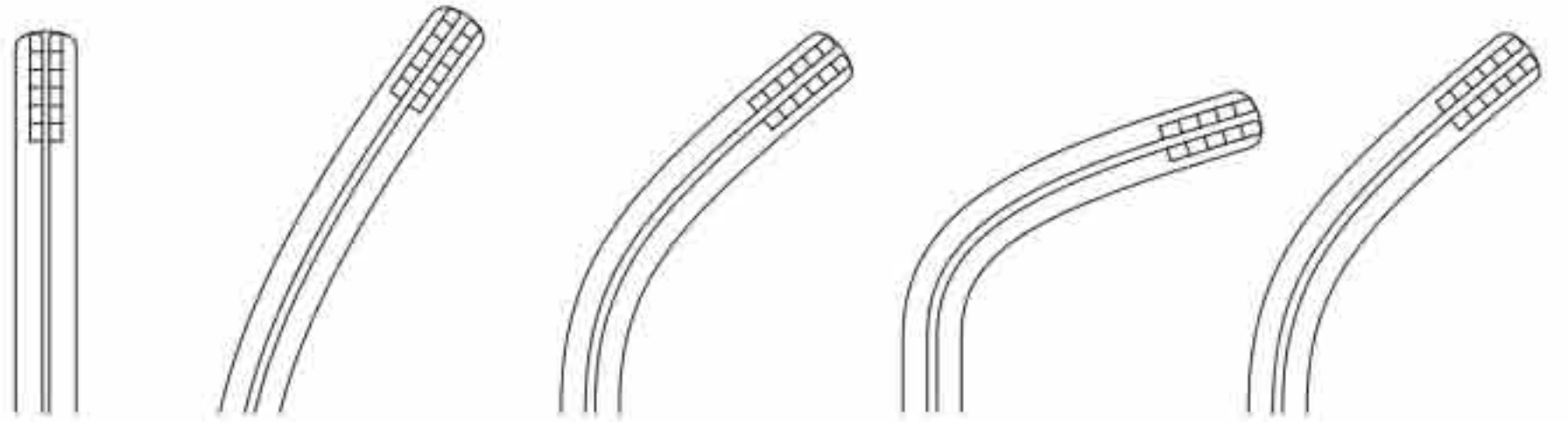

210 mm – 8 ¼ "	01-1912-01	01-1913-01	01-1914-01	01-1915-01	01-1916-01
240 mm – 9 ½ "	01-1912-02	01-1913-02	01-1914-02	01-1915-02	01-1916-02
260 mm – 10 ¼ "	01-1912-03	01-1913-03	01-1914-03	01-1915-03	01-1916-03
300 mm – 12 "	01-1912-04	01-1913-04	01-1914-04	01-1915-04	01-1916-04
350 mm – 13 ¾ "	01-1912-05	01-1913-05	01-1914-05	01-1915-05	01-1916-05

S-curved

Lung grasping forceps

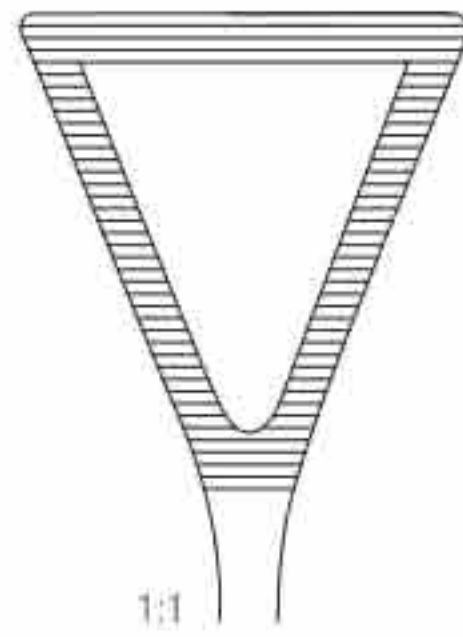

loveAce

1:2

1:2

200 mm - 8"	01-1917	01-1918
-------------	---------	---------

Bronchus and vascular clamps



price-thomAs 1:1

220 mm - 8 3/4 "	01-1919
------------------	---------

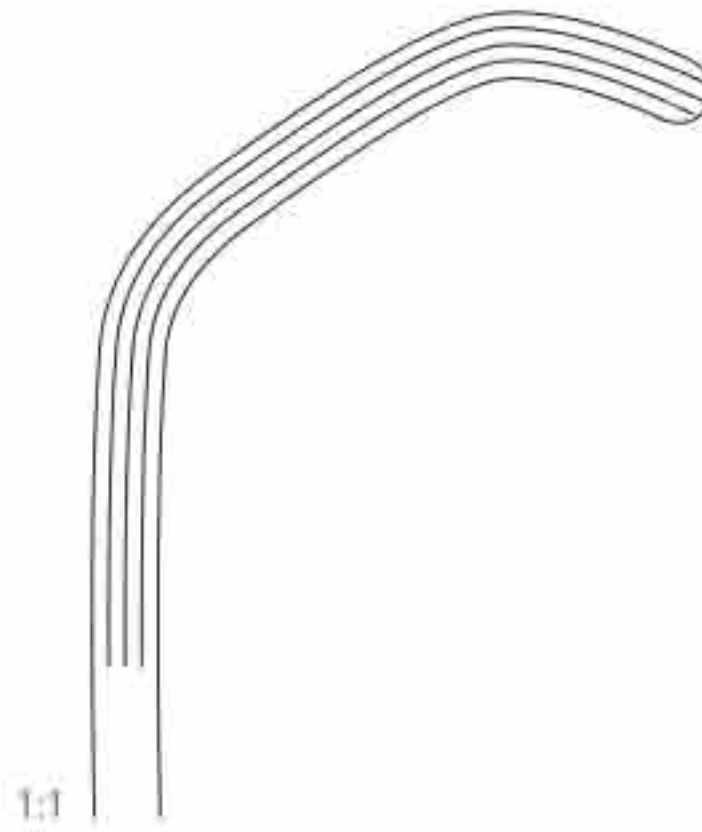

price-thomAs 1:1 1:1

220 mm - 8 3/4 "	01-1920-01	01-1920-02
------------------	------------	------------

Pins left

Pins right

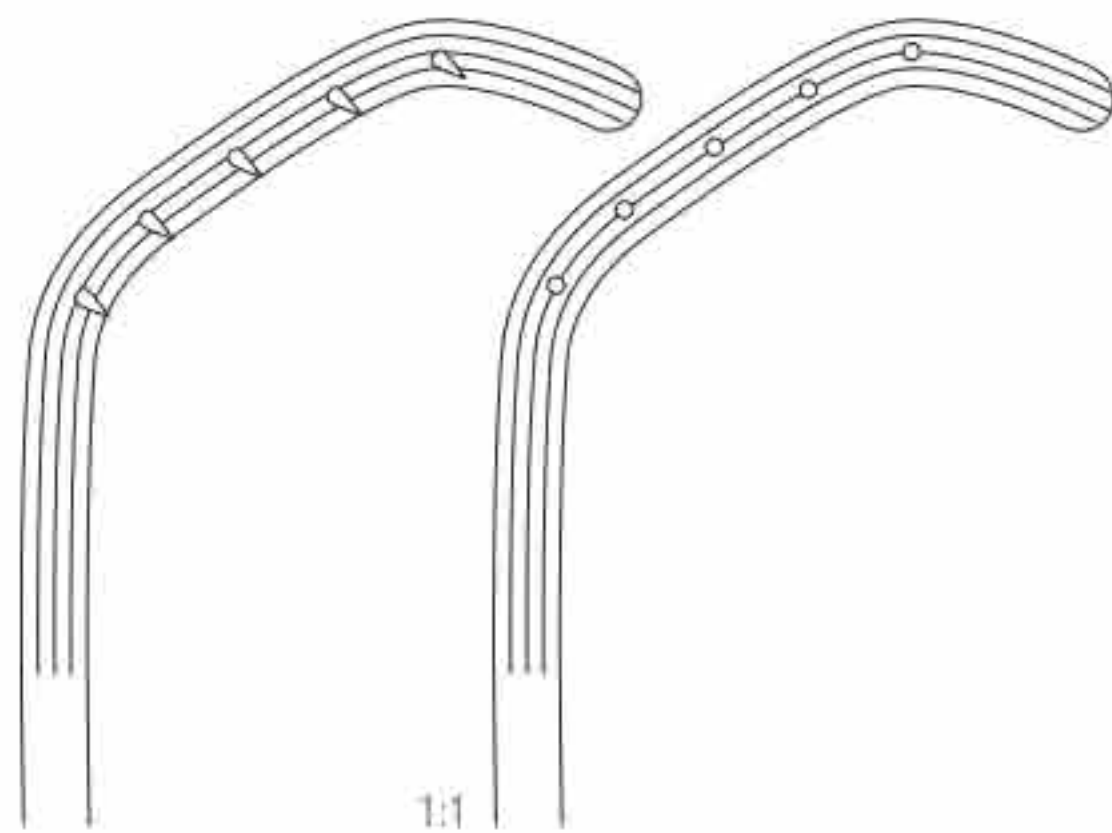

Bronchus and vascular clamps

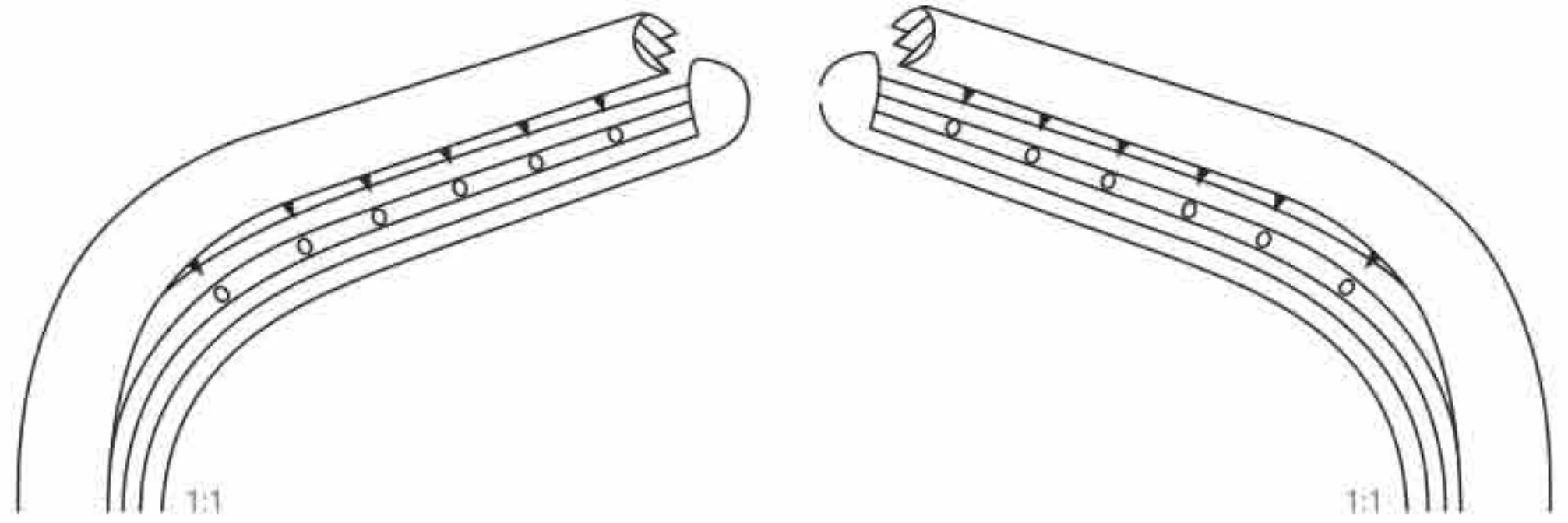

sArot

230 mm - 9"	01-1921-01	01-1921-02
-------------	------------	------------

Pins left

Pins right

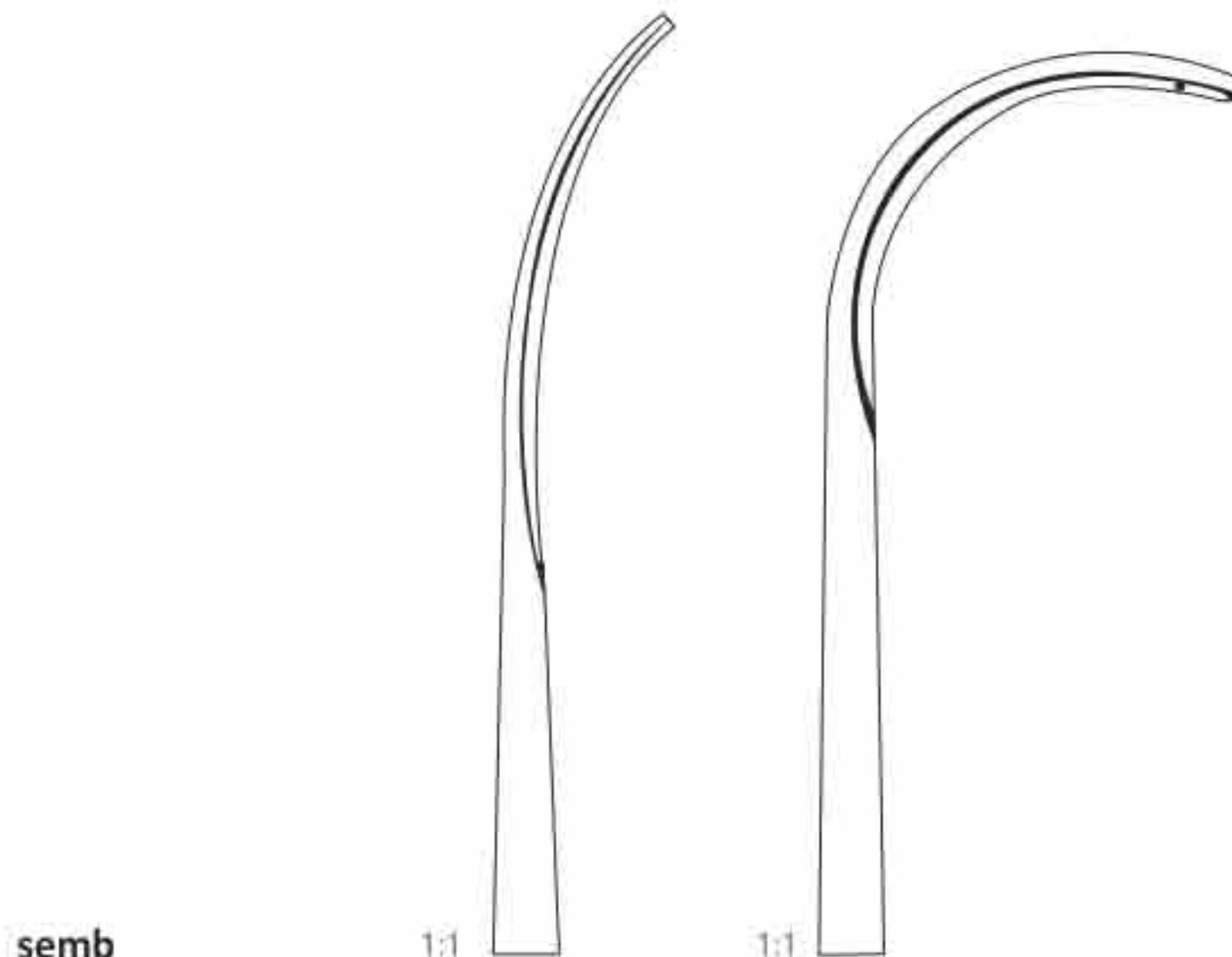

semb

240 mm - 9 1/2"	01-1922-01	01-1922-02
-----------------	------------	------------

Bronchus and vascular clamps



bAbY-sAtinsky	1:1
150 mm – 6"	01-1923

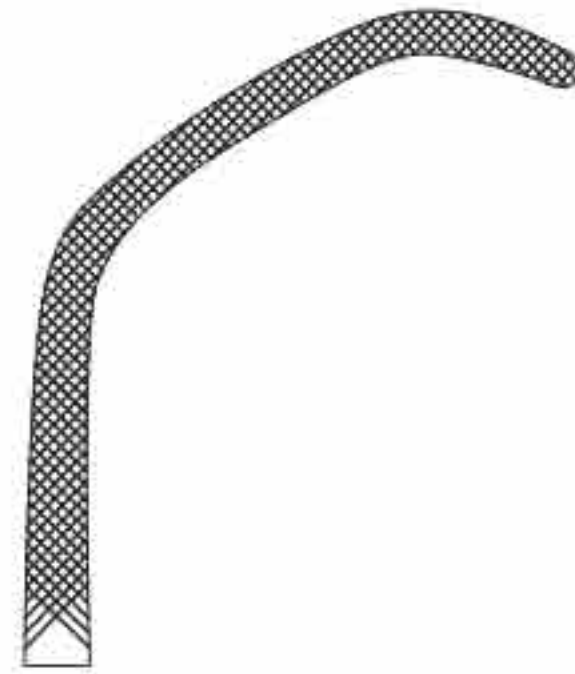

sAtinsky	1:1	1:1	1:1	1:1
	Fig. 1	Fig. 1	Fig. 2	Fig. 2
265 mm – 10½"	01-1924	01-1925	01-1926	01-1927

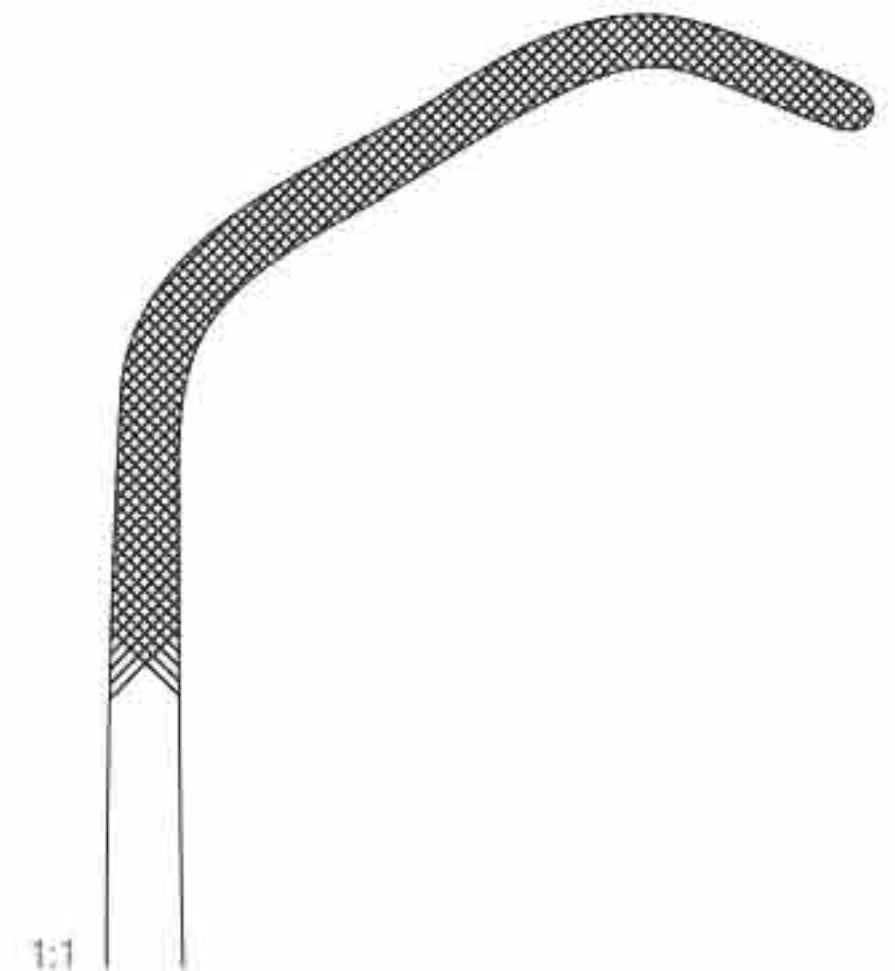
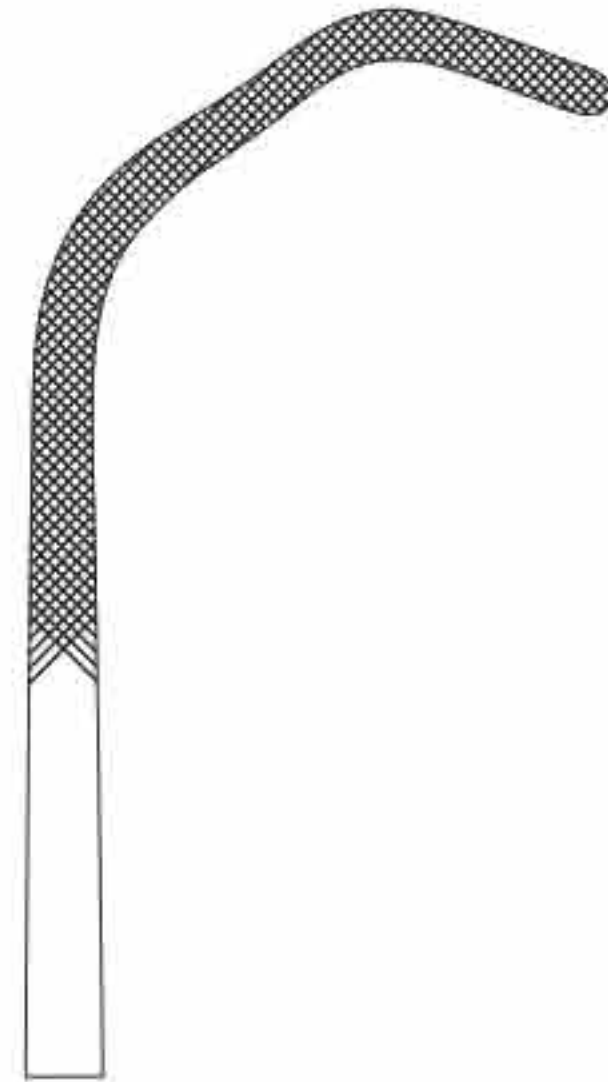

S-curved

S-curved

Towel forceps



bernhArD

100 mm – 4 "	01-1928-01
120 mm – 4 ¾ "	01-1928-02
140 mm – 5 ½ "	01-1928-03
165 mm – 6 ½ "	01-1928-04
180 mm – 7 "	01-1928-05



bAckhAus

80 mm – 3 "	01-1929-01
90 mm – 3 ½ "	01-1929-02
110 mm – 4 ¼ "	01-1929-03
130 mm – 5 "	01-1929-04
150 mm – 6 "	01-1929-05



roeDer

130 mm – 5 "	01-1930-01
150 mm – 6 "	01-1930-02



1:2

110 mm – 4 "	01-1931
--------------	---------

with clip for tube

Towel forceps



robin 1:2

135 mm – 5 ¼ "	01-1932
----------------	---------

with clip for tube up to 5 mm Ø



Jones

50 mm – 2 "	01-1933-01
90 mm – 3 ½ "	01-1933-02



schAeDel 1:2

90 mm – 3 ½ "	01-1934-01	01-1934-02
---------------	------------	------------

straight



DoYen 1:2

180 mm – 7 "	01-1935
--------------	---------



IornA

100 mm – 4 "	01-1936-01
130 mm – 5 "	01-1936-02

Towel forceps



Iane

130 mm – 5"	01-1937-01
150 mm – 6"	01-1937-02
200 mm – 8"	01-1937-03



tohoku-JApAn

100 mm – 4"	01-1938-01
130 mm – 5"	01-1938-02



1:2

peers-bertrAm

145 mm – 5 ¾"	01-1939
---------------	---------



110 mm – 4 ¾"	01-1940-01
130 mm – 5"	01-1940-02

for paper clothes

Tubing clamps



150 mm – 6"	01-1941-01
160 mm – 7"	01-1941-02
190 mm – 8"	01-1941-03



150 mm – 6"	01-1942-01
180 mm – 7"	01-1942-02
200 mm – 8"	01-1942-03



165 mm – 6 ½"	01-1943-01
180 mm – 7"	01-1943-02

with protection



1:2

klinikum-berlin

145 mm – 5 ¾"	01-1944
---------------	---------

with extra long ratchet



1:2

GunnAr

185 mm – 7 ¼"	01-1945
---------------	---------

Bulldog clamps

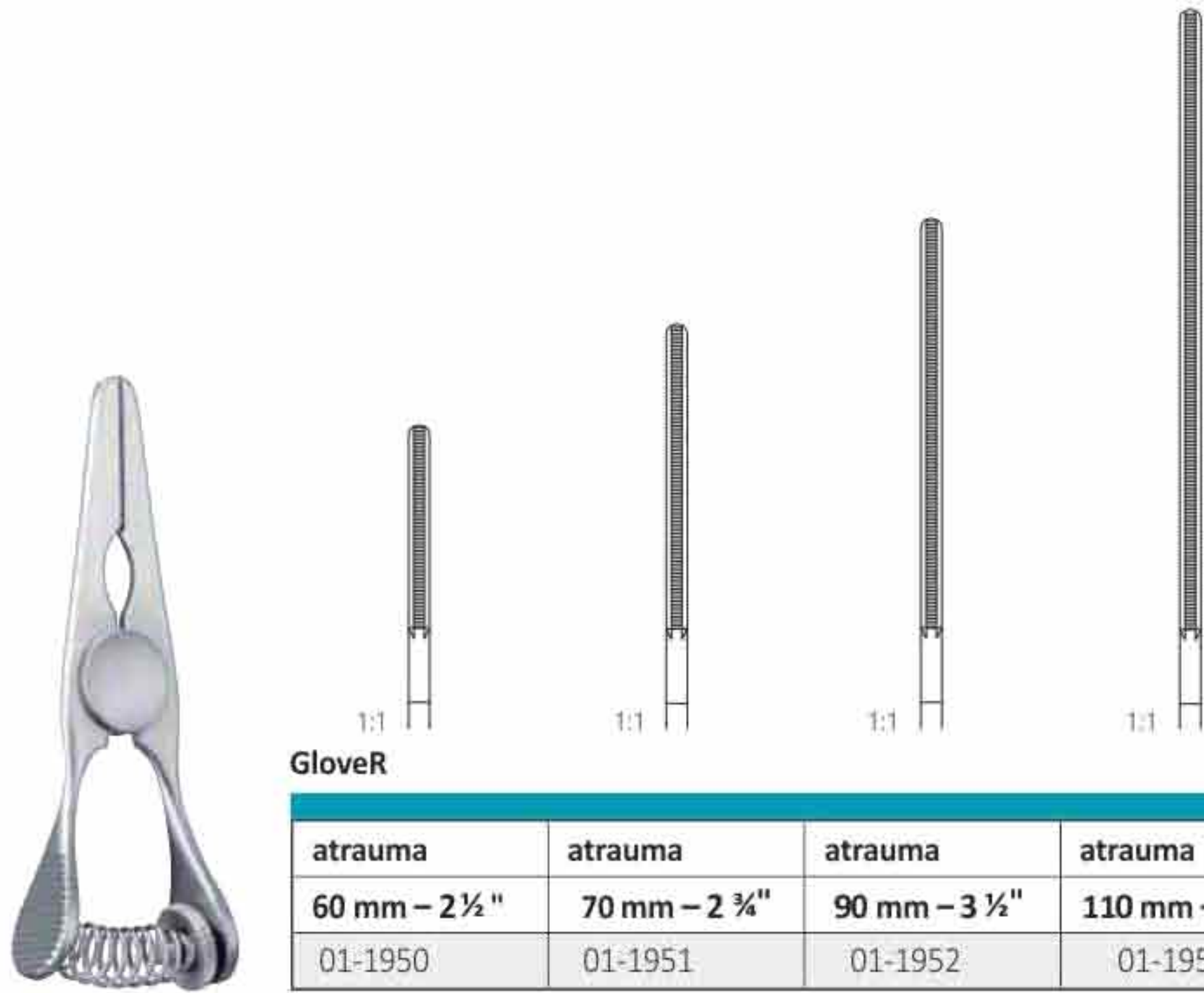

Glover

atrauma	atrauma	atrauma	atrauma
60 mm – 2 ½"	70 mm – 2 ¾"	90 mm – 3 ½"	110 mm – 4 ¼"
01-1950	01-1951	01-1952	01-1953

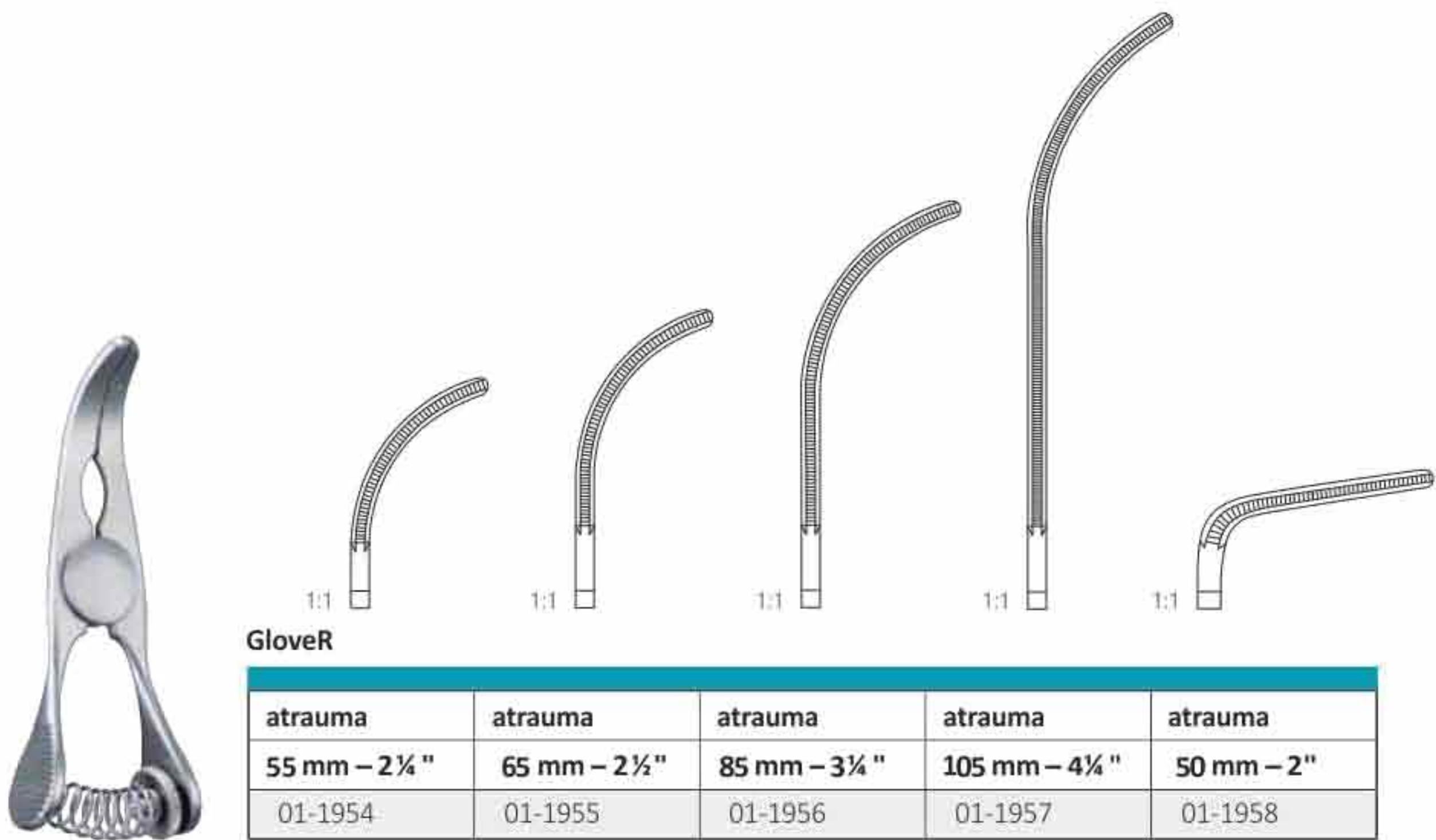

Glover

atrauma	atrauma	atrauma	atrauma	atrauma
55 mm – 2 ¼"	65 mm – 2 ½"	85 mm – 3 ¼"	105 mm – 4 ¼"	50 mm – 2"
01-1954	01-1955	01-1956	01-1957	01-1958

angled on flat

Bulldog clamps



1:1
De BaKey-satinsky

atrauma
70 mm – 2 ¾ "
01-1959



1:1
De BaKey-caRotis

atrauma
90 mm – 3 ½ "
01-1960

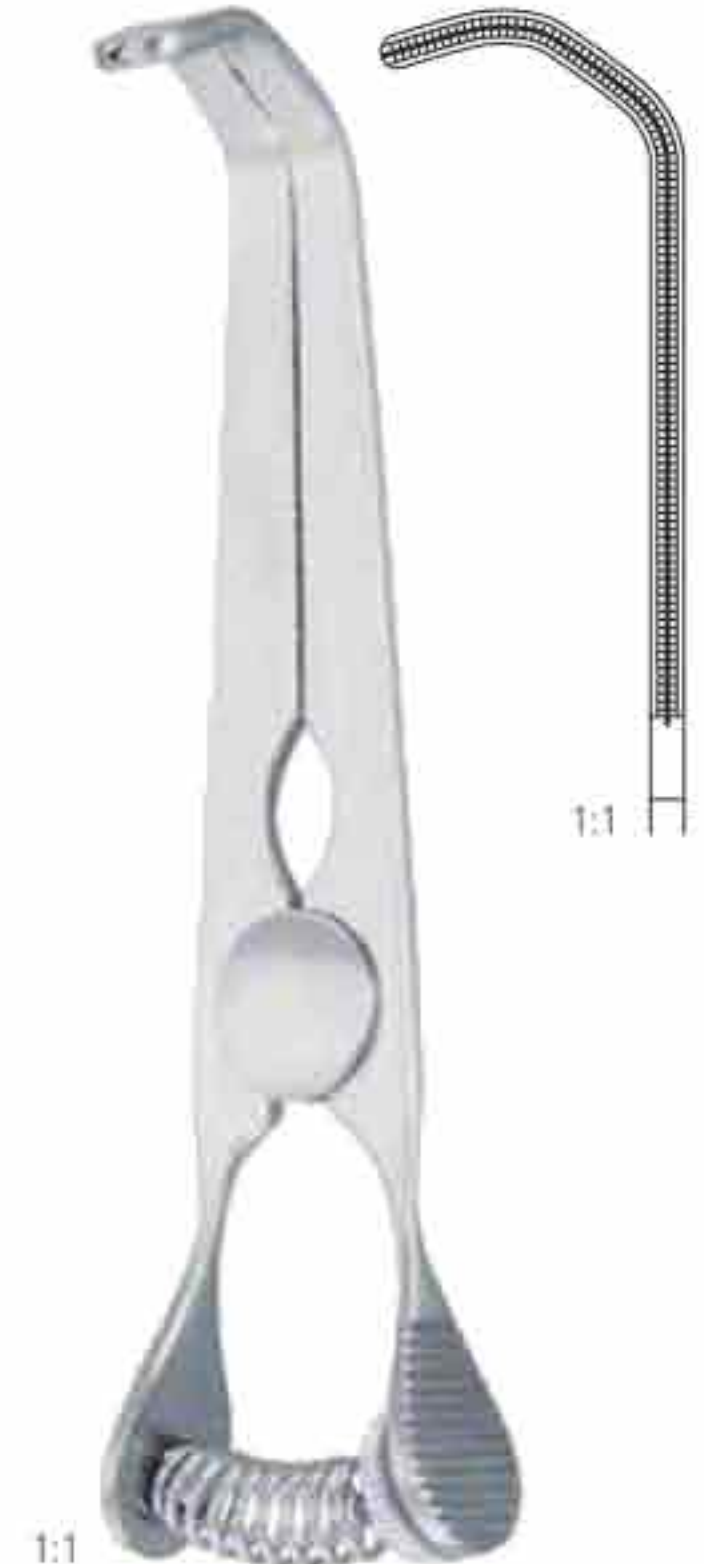

1:1
De BaKey-satinsky

atrauma
100 mm – 4 "
01-1961



santulli

atrauma
70 mm – 2 ¾ "
01-1962

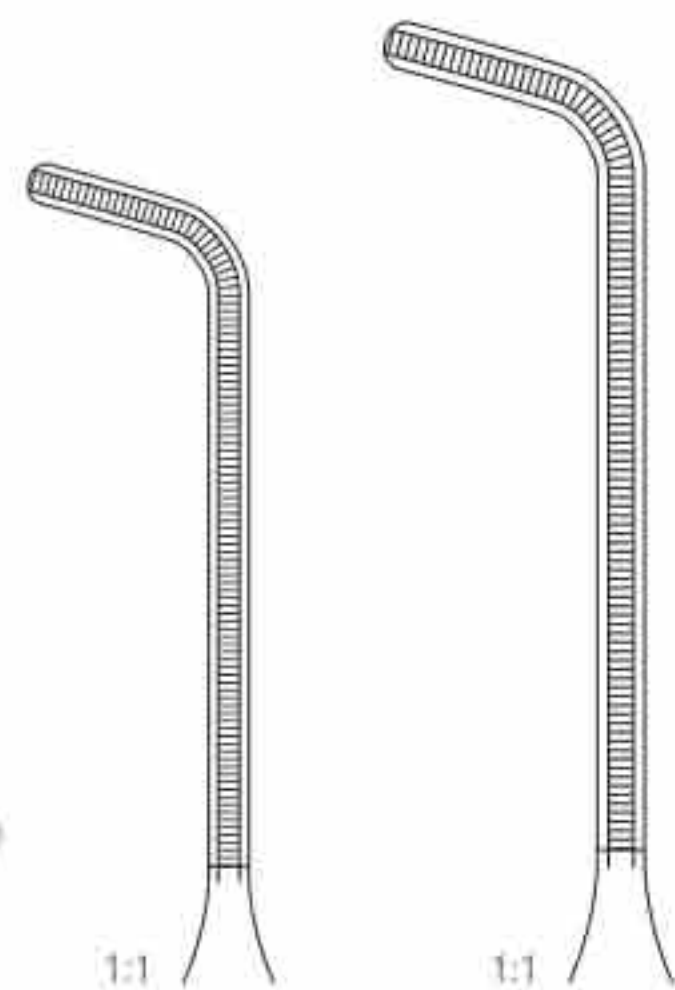

GReGoRy-soft

atrauma	atrauma
90 mm – 3 ½ "	110 mm – 4 ¼ "
01-1963-01	01-1963-02

Atraumatic tissue forceps

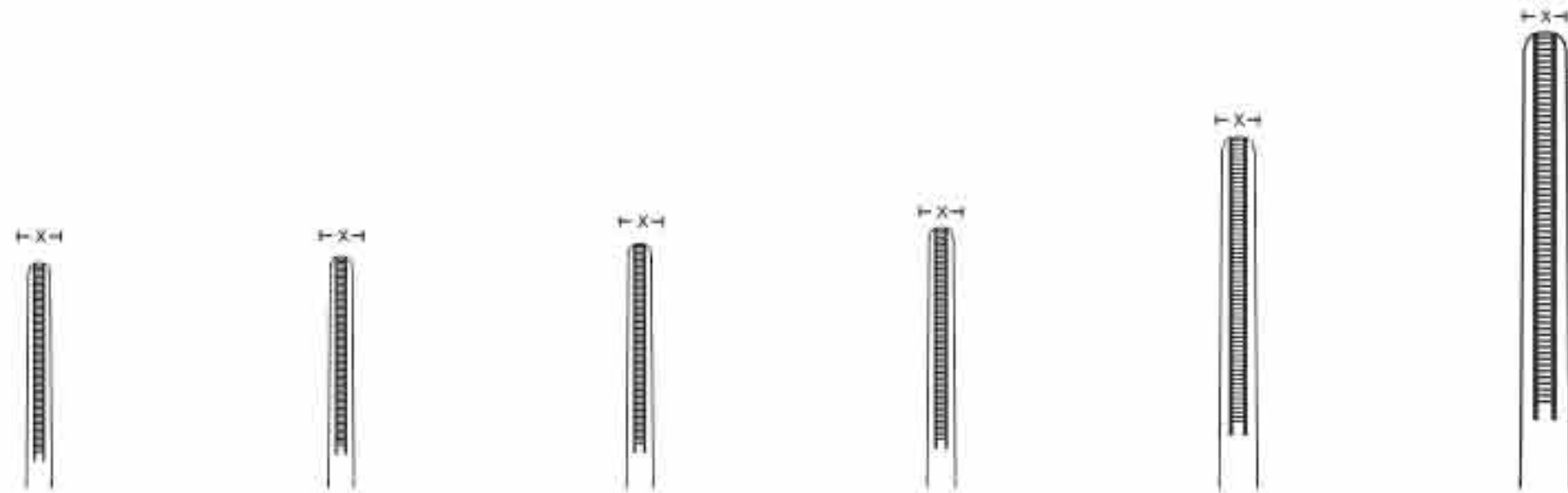

De BaKey

	atrauma	atrauma	atrauma	atrauma	atrauma	atrauma
	x = 1.0 mm	x = 1.2 mm	x = 1.5 mm	x = 2.0 mm	x = 2.8 mm	x = 3.5 mm
150 mm – 6"	01-1964-01	01-1965-01	01-1966-01	01-1967-01	01-1968-01	01-1969-01
200 mm – 8"	01-1964-02	01-1965-02	01-1966-02	01-1967-02	01-1968-02	01-1969-02
240 mm – 9 ½"	01-1964-03	01-1965-03	01-1966-03	01-1967-03	01-1968-03	01-1969-03
300 mm – 12"		01-1965-04	01-1966-04	01-1967-04	01-1968-04	01-1969-04
350 mm – 13 ¾"				01-1967-05	01-1968-05	01-1969-05
380 mm – 15"					01-1968-06	01-1969-06
400 mm – 15 ¾"					01-1968-07	



De BaKey

	light Weight	light Weight	light Weight
	x = 1.2 mm	x = 1.5 mm	x = 2.0 mm
150 mm – 6"	01-1970		01-1972
200 mm – 8"		01-1971-01	
240 mm – 9 ½"		01-1971-02	
300 mm – 12"		01-1971-03	

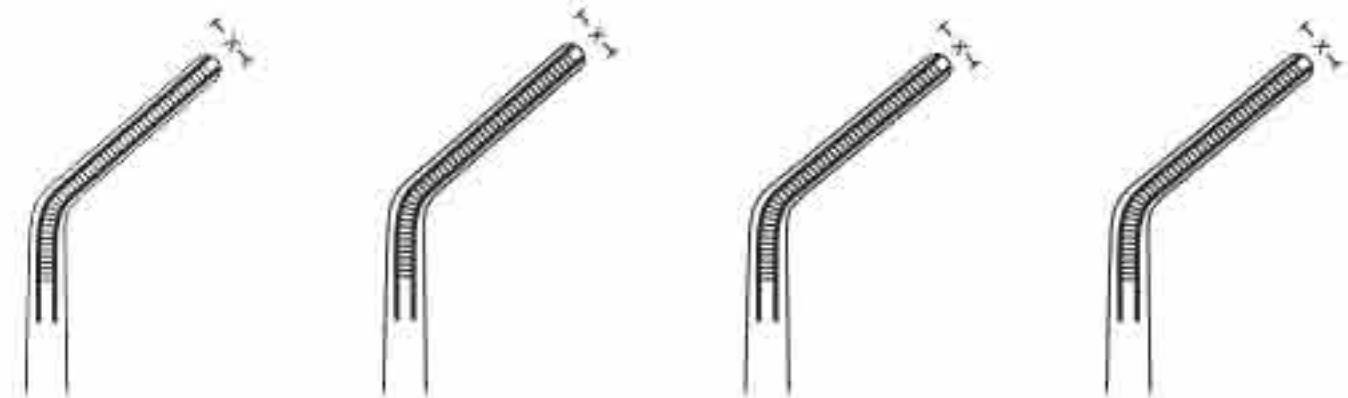

De BaKey

	atrauma	atrauma	atrauma	light Weight
	x = 1.5 mm	x = 2.0 mm	x = 3.5 mm	x = 2.0 mm
150 mm – 6"	01-1973	01-1974-01	01-1975-01	01-1976
200 mm – 8"		01-1974-02	01-1975-02	
240 mm – 9 ½"		01-1974-03	01-1975-03	
300 mm – 12"		01-1974-04	01-1975-04	

Atraumatic tissue forceps

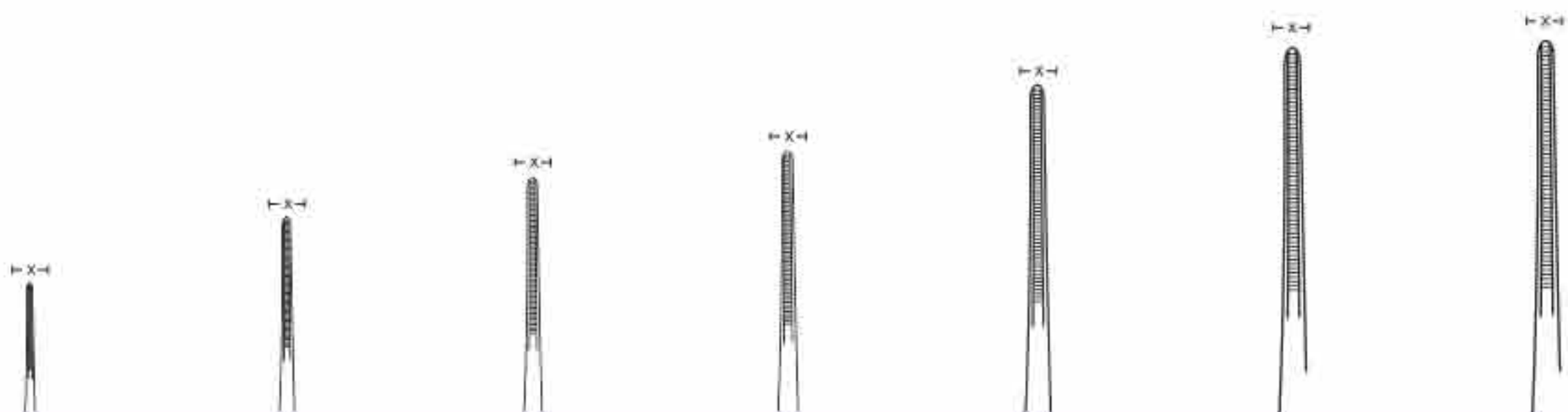

De BaKey

	titan / atrauma	titan / atrauma	titan / atrauma	titan / atrauma	titan / atrauma	titan / atrauma	titan / atrauma
	x = 1.0 mm	x = 1.5 mm	x = 1.8 mm	x = 2.0 mm	x = 2.5 mm	x = 2.8 mm	x = 3.5 mm
150 mm – 6"	01-1977-01	01-1978-01	01-1979-01	01-1980-01	01-1981-01	01-1982-01	01-1983-01
200 mm – 8"	01-1977-02	01-1978-02	01-1979-02	01-1980-02	01-1981-02	01-1982-02	01-1983-02
240 mm – 9 ½"	01-1977-03	01-1978-03	01-1979-03	01-1980-03	01-1981-03	01-1982-03	01-1983-03
300 mm – 12"				01-1980-04	01-1981-04	01-1982-04	01-1983-04
350 mm – 13 ¾"							01-1983-05



De BaKey

	titan / atrauma	titan / atrauma	titan / atrauma
	x = 1.5 mm	x = 2.0 mm	x = 2.4 mm
160 mm – 6 ¼"	01-1984-01	01-1985-01	
200 mm – 8"	01-1984-02	01-1985-02	01-1986
240 mm – 9 ½"		01-1985-03	
300 mm – 12"		01-1985-04	

Atraumatic tissue forceps

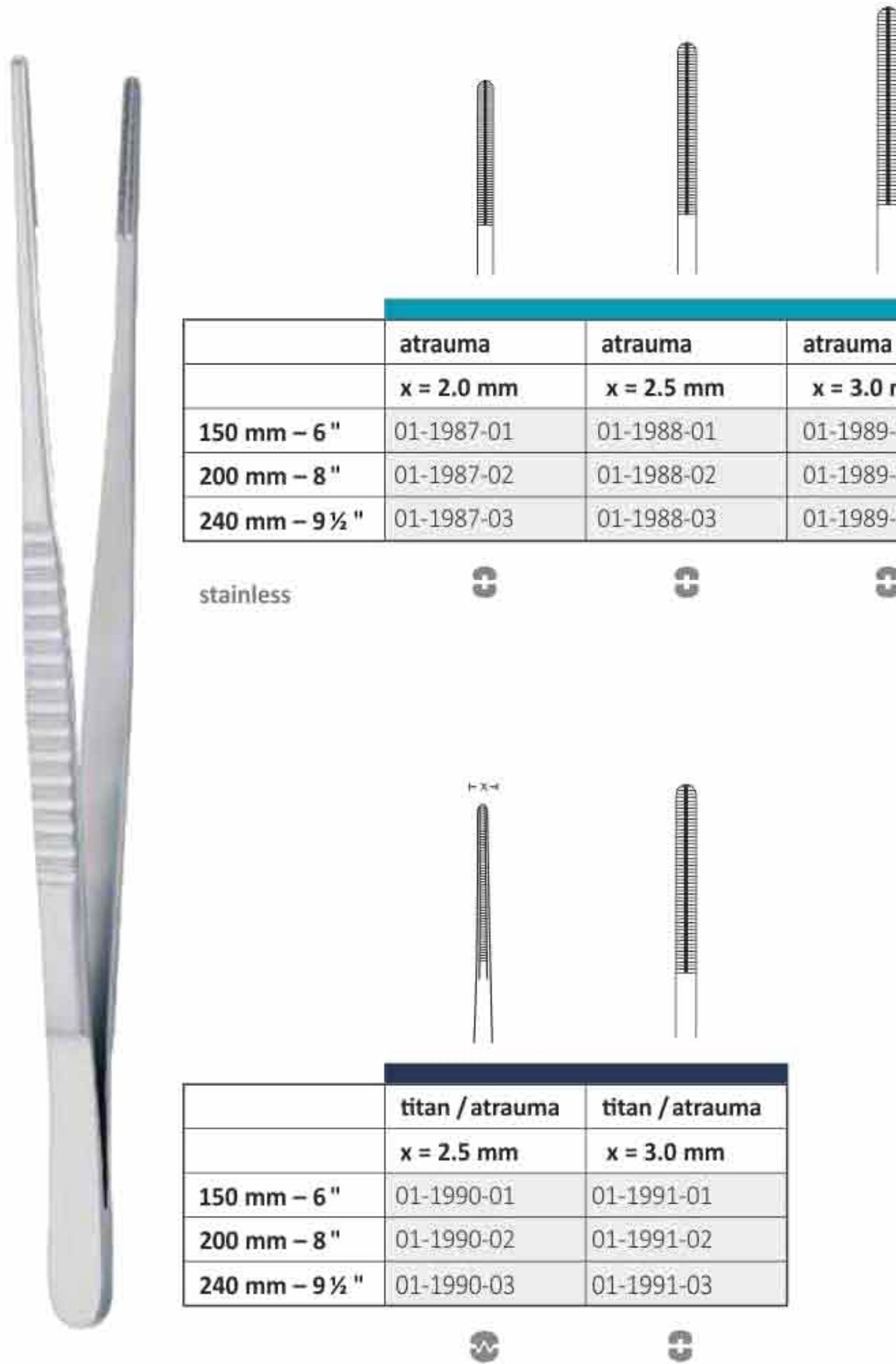

	atrauma	atrauma	atrauma
	x = 2.0 mm	x = 2.5 mm	x = 3.0 mm
150 mm – 6"	01-1987-01	01-1988-01	01-1989-01
200 mm – 8"	01-1987-02	01-1988-02	01-1989-02
240 mm – 9 ½"	01-1987-03	01-1988-03	01-1989-03

stainless



	titan / atrauma	titan / atrauma
	x = 2.5 mm	x = 3.0 mm
150 mm – 6"	01-1990-01	01-1991-01
200 mm – 8"	01-1990-02	01-1991-02
240 mm – 9 ½"	01-1990-03	01-1991-03



Ring handle Bulldog clamps

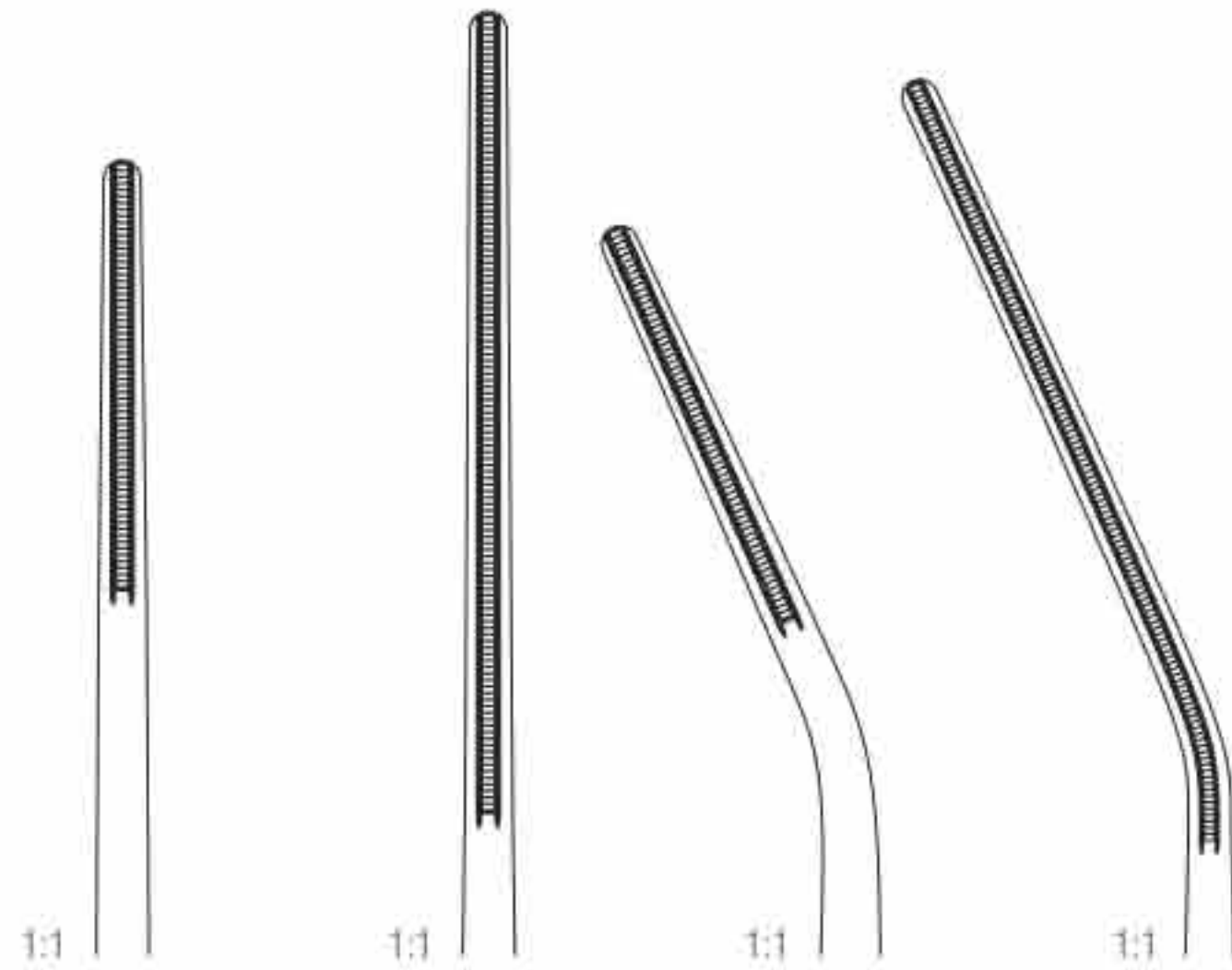

potts

atrauma	atrauma	atrauma	atrauma
200 mm – 8"	220 mm – 8¾"	200 mm – 8"	220 mm – 8¾"
01-1992	01-1993	01-1994	01-1995

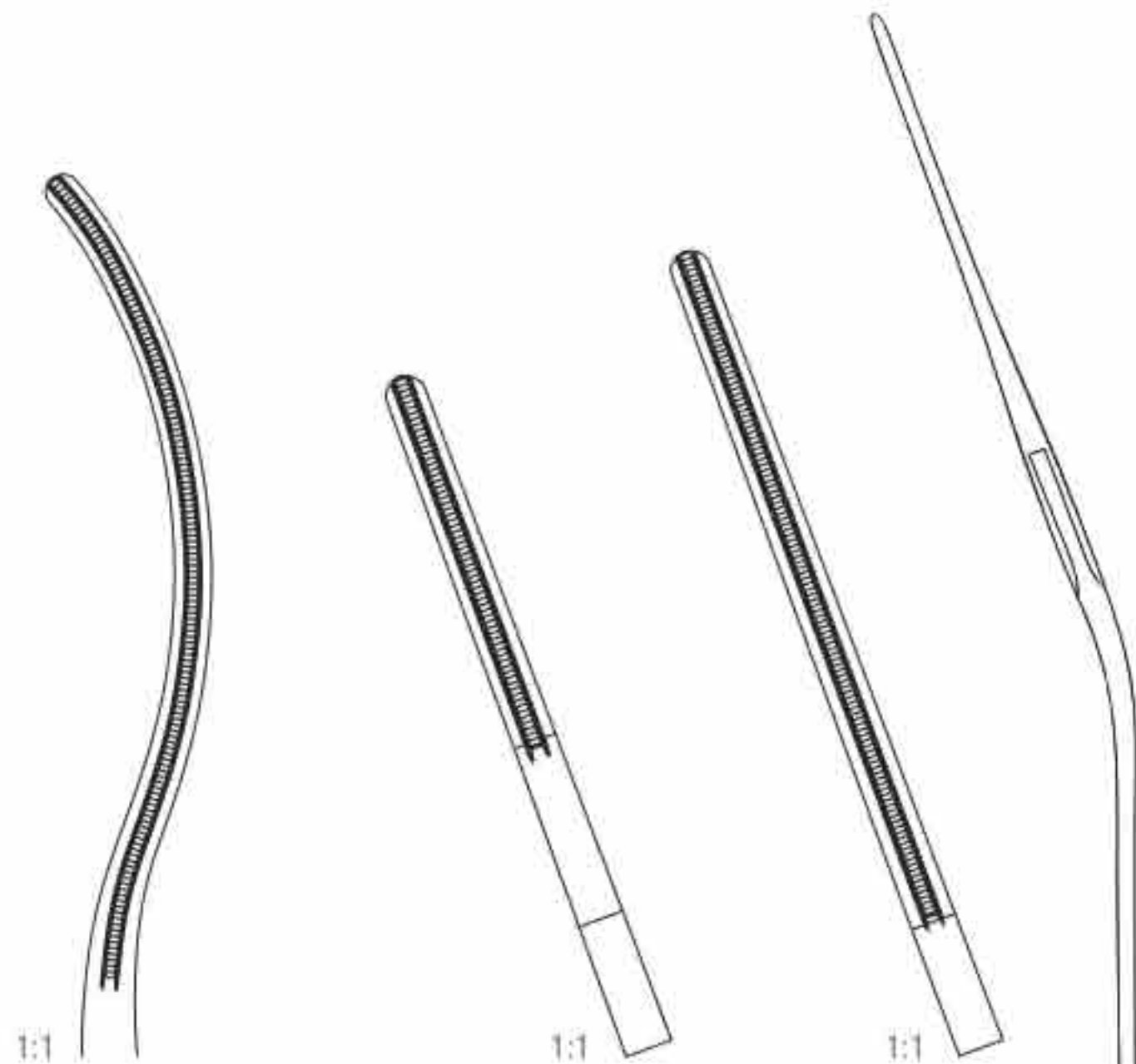

potts

atrauma	atrauma	atrauma
220 mm – 8¾"	210 mm – 8¼"	220 mm – 8¾"
01-1996	01-1997	01-1998

Vascular forceps

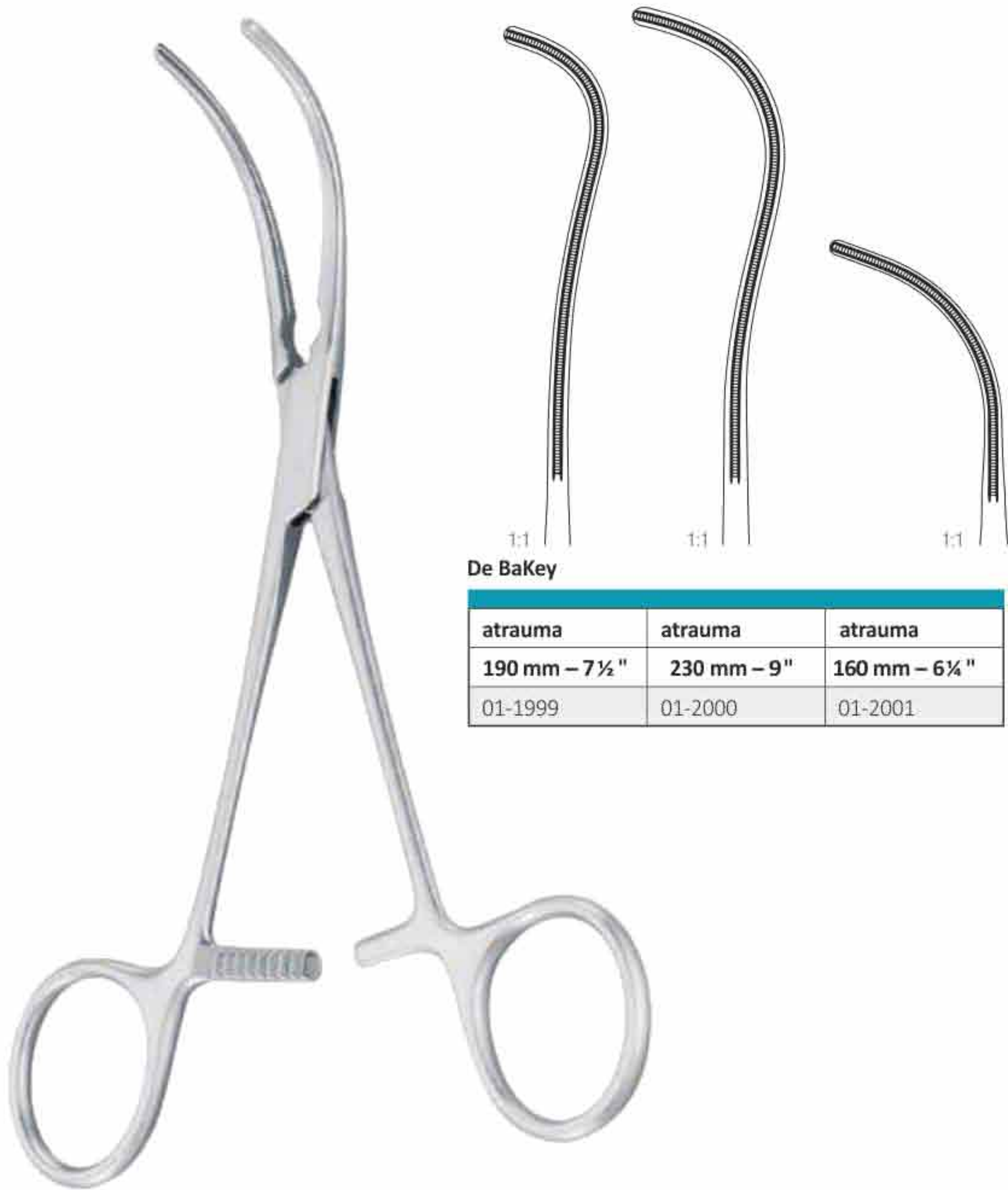

De BaKey

atrauma	atrauma	atrauma
190 mm – 7½"	230 mm – 9"	160 mm – 6¼"
01-1999	01-2000	01-2001

Vascular forceps

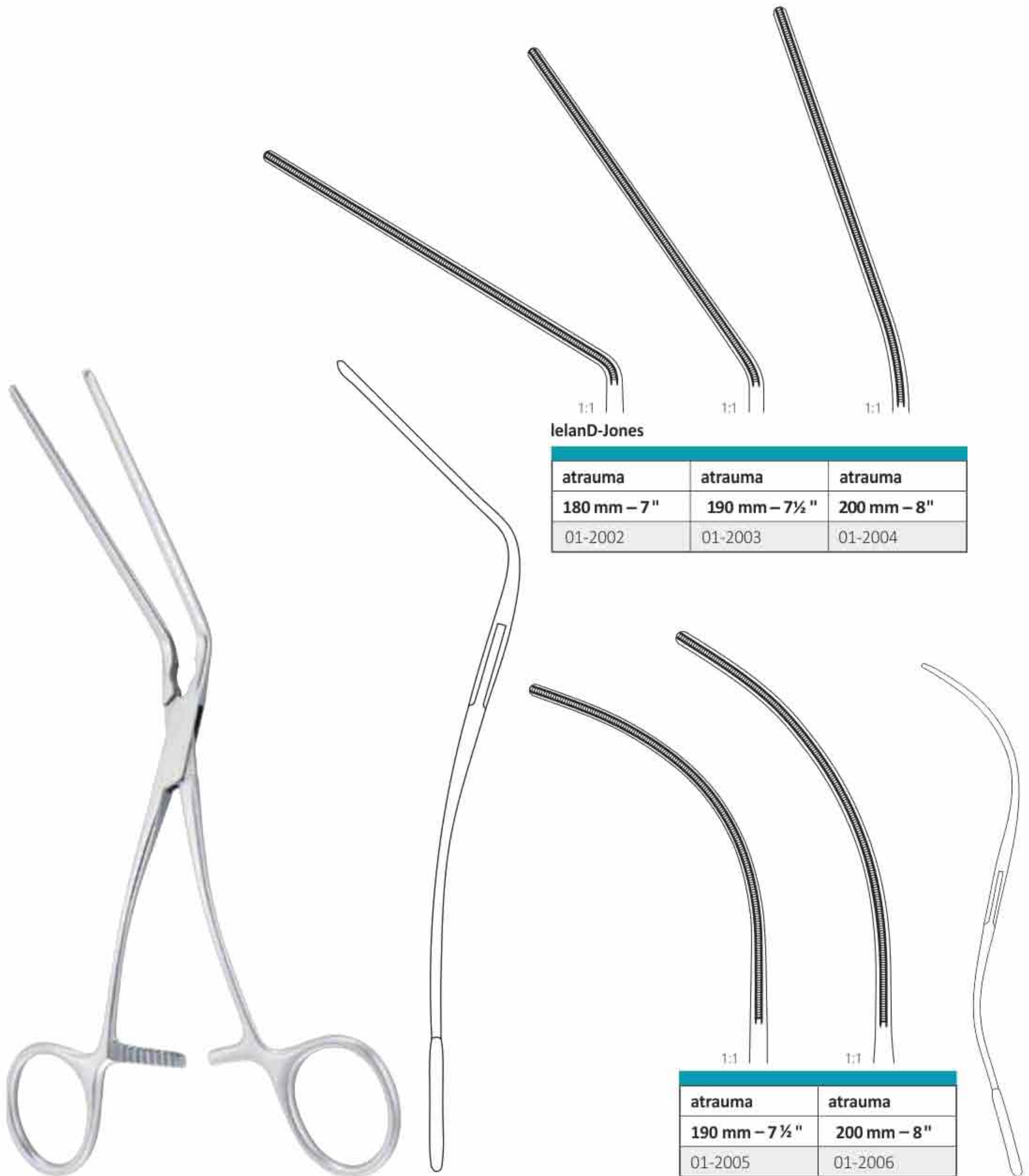

leland-Jones

atrauma	atrauma	atrauma
180 mm – 7"	190 mm – 7½"	200 mm – 8"
01-2002	01-2003	01-2004

atrauma	atrauma
190 mm – 7½"	200 mm – 8"
01-2005	01-2006

Vascular forceps

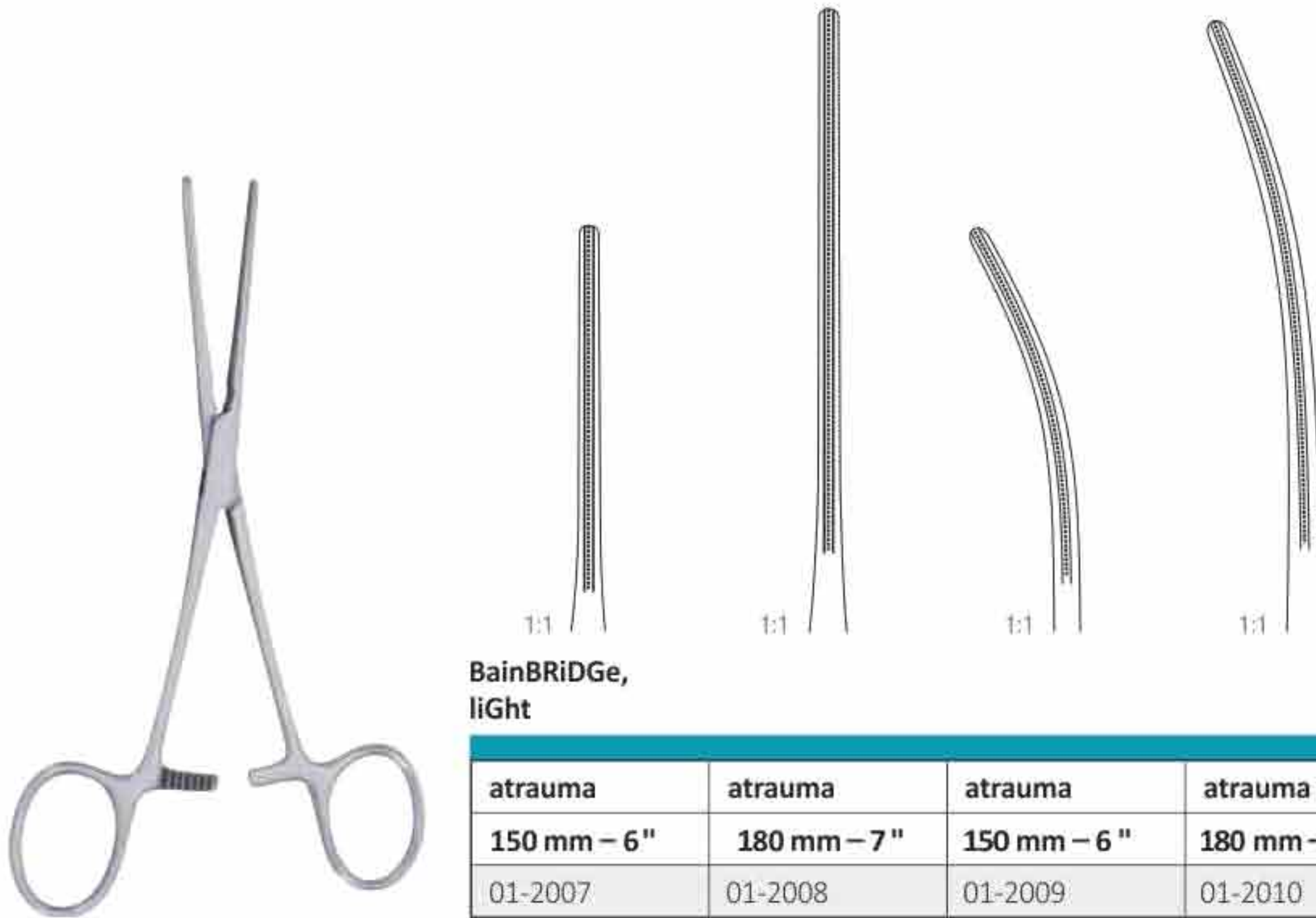

**BainBRIDGE,
light**

atrauma	atrauma	atrauma	atrauma
150 mm – 6"	180 mm – 7"	150 mm – 6"	180 mm – 7"
01-2007	01-2008	01-2009	01-2010

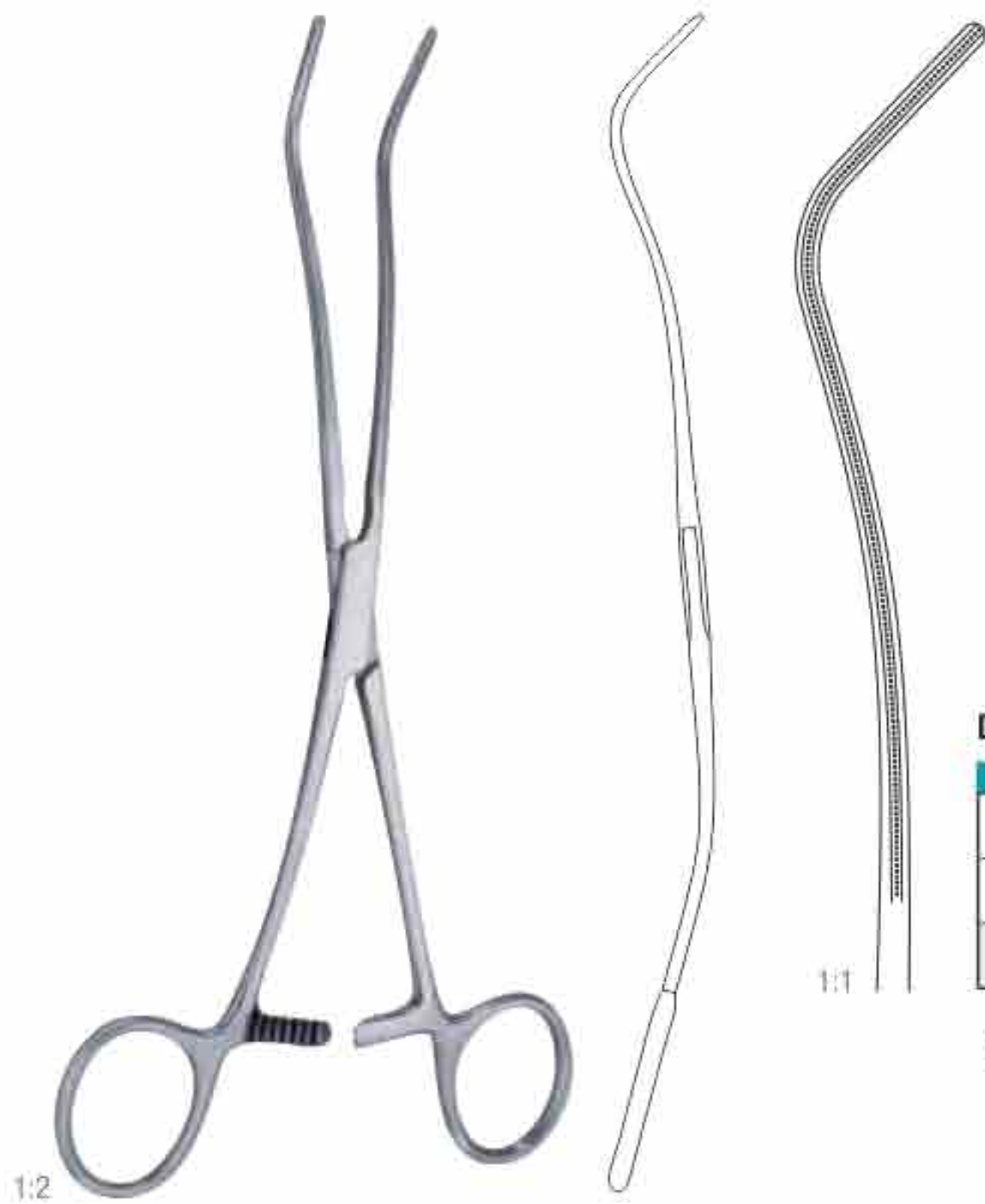

De BaKey

atrauma
200 mm – 8"
01-2011

S-curved

Vascular forceps



De BaKey

atrauma	atrauma	atrauma	atrauma
260 mm – 10 ¼ "	270 mm – 10 ¾ "	310 mm – 12 ¼ "	330 mm – 13 ¾ "
01-2012	01-2013	01-2014	01-2015

C-curved

Vascular forceps



De BaKey

atrauma	atrauma
280 mm – 11 "	280 mm – 11 "
01-2016	01-2017

S-curved

Vascular forceps

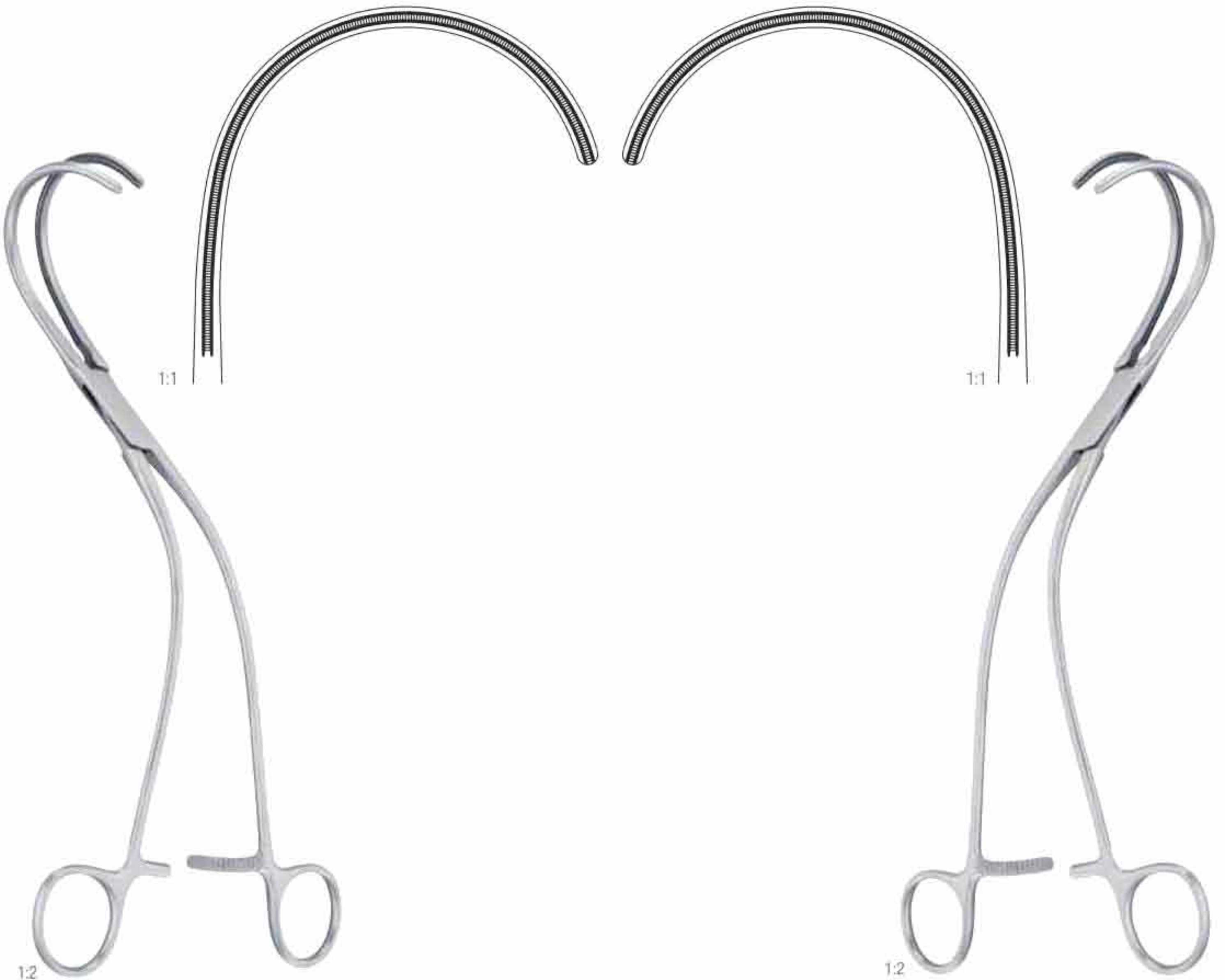

1:2
WeBeR

1:2

atrauma	atrauma
260 mm – 10 ¼ "	260 mm – 10 ¼ "
01-2018	01-2019

curved left

curved right

Vascular forceps

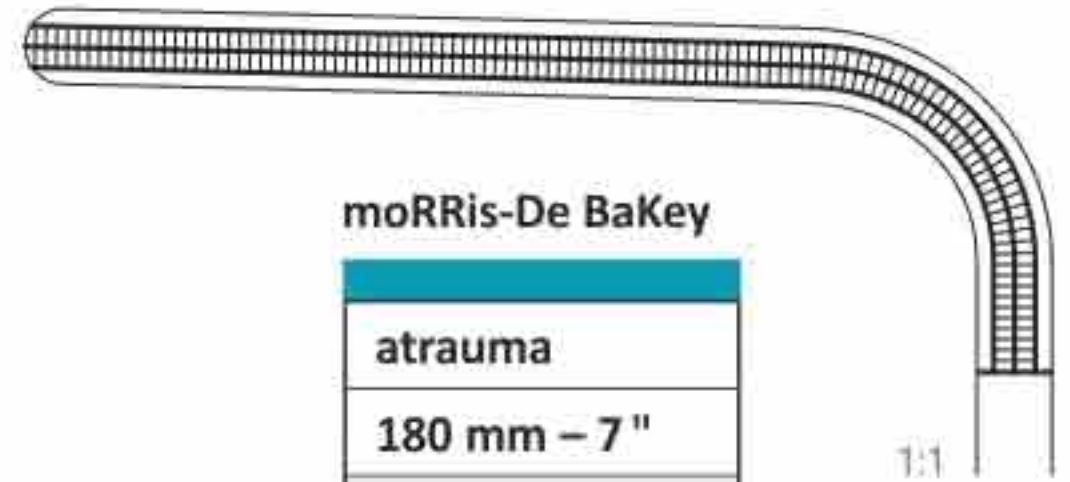

moRRis-De BaKey

atrauma
180 mm – 7"
01-2020

1:1

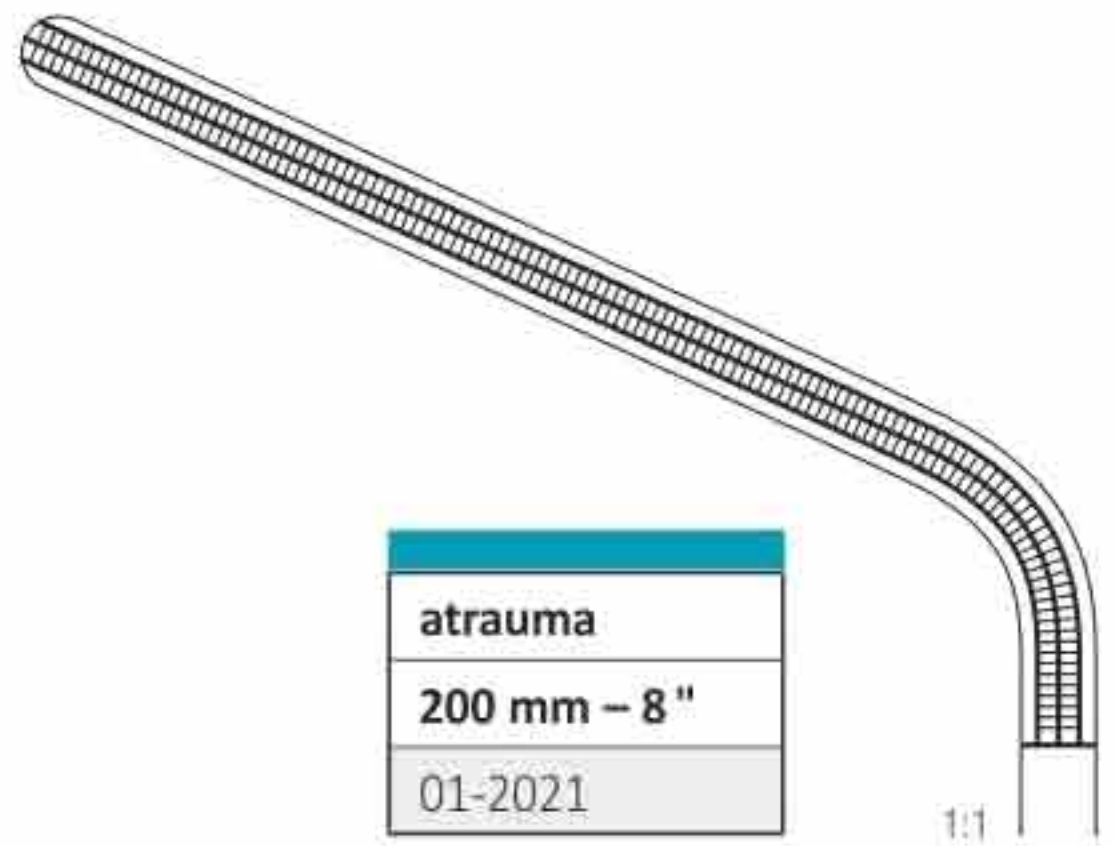

atrauma
200 mm – 8"
01-2021

1:1

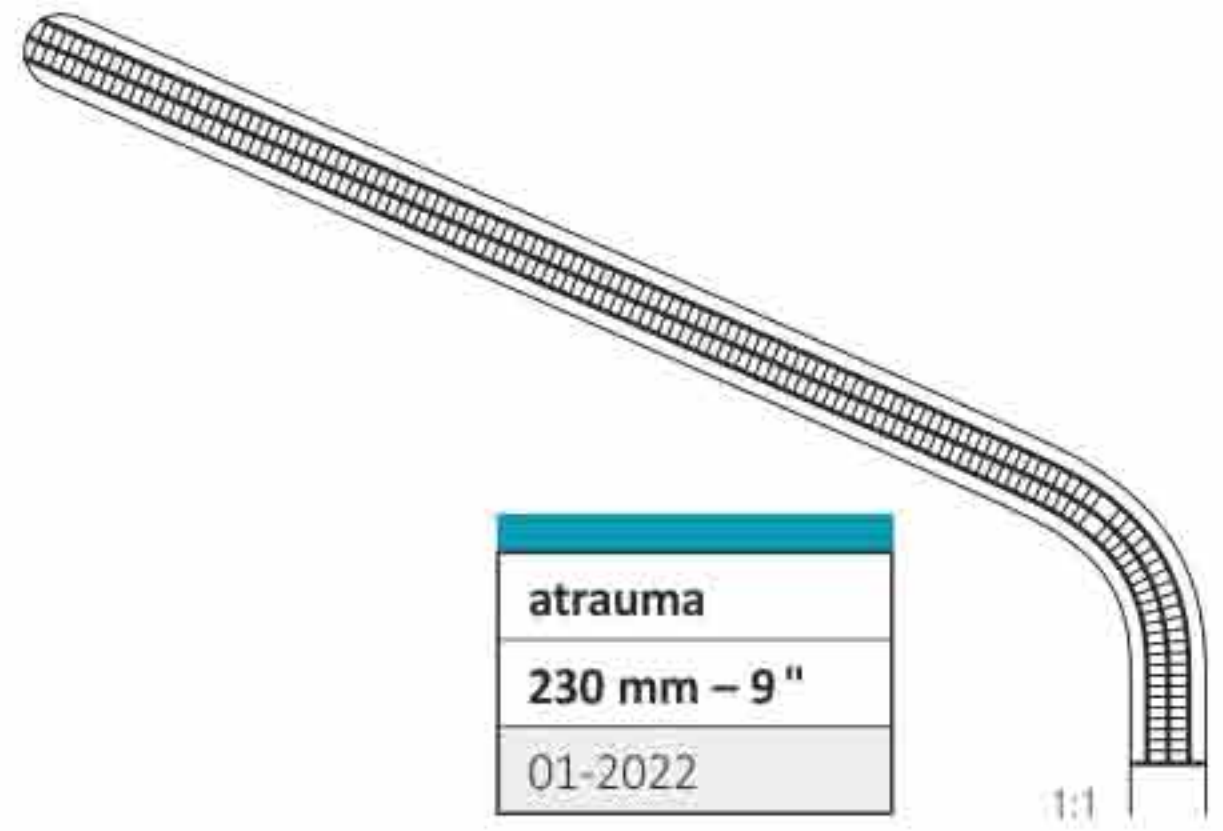

atrauma
230 mm – 9"
01-2022

1:1

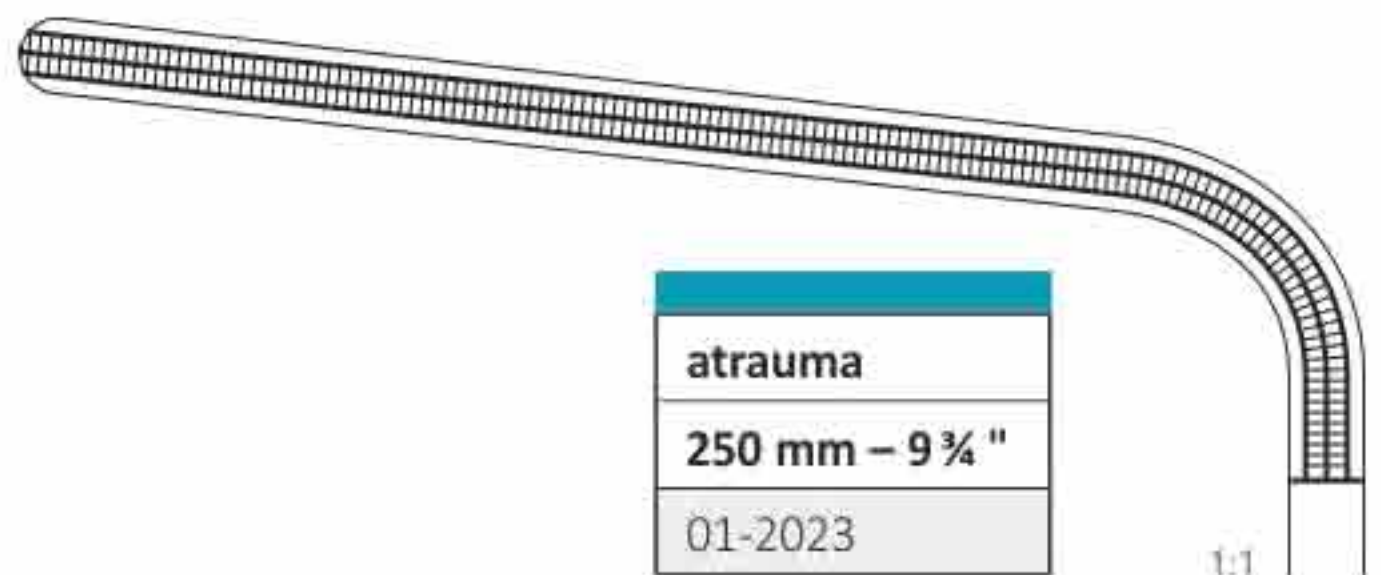

atrauma
250 mm – 9 ¼"
01-2023

1:1

Vascular forceps

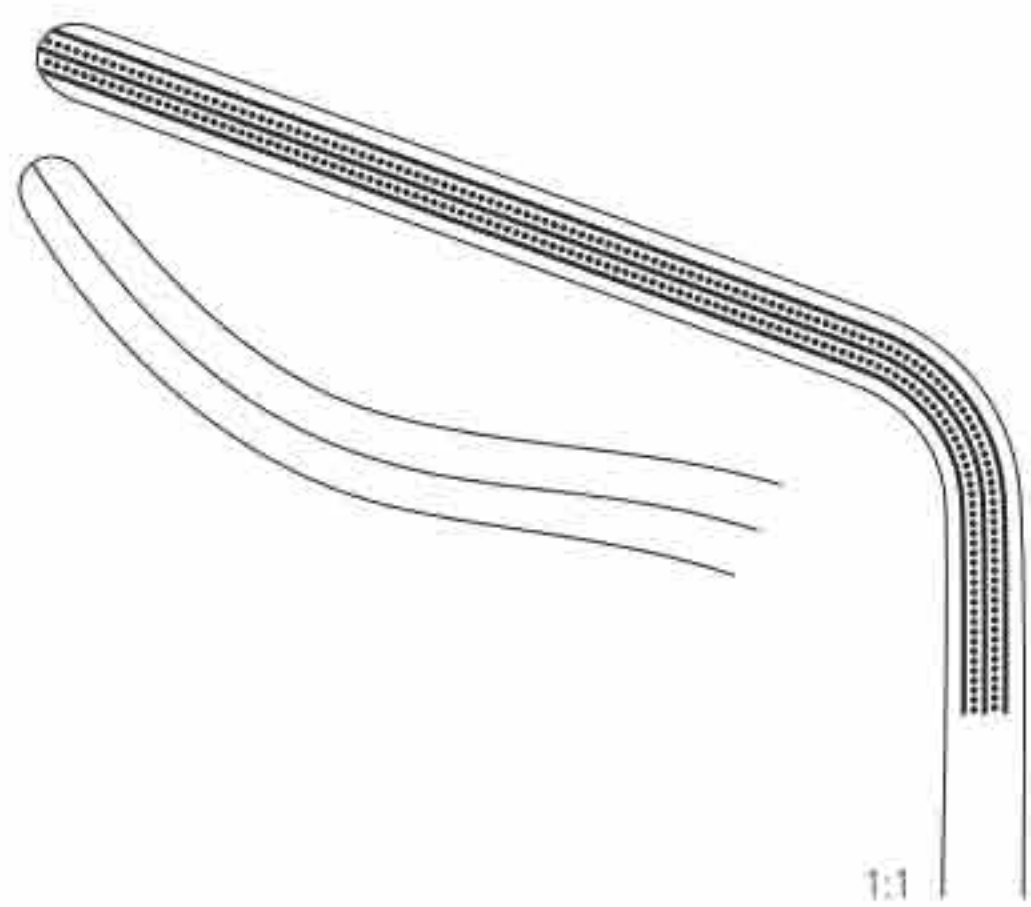

De BaKey

atrauma
270 mm – 10³/₄ "
01-2024

Vascular forceps

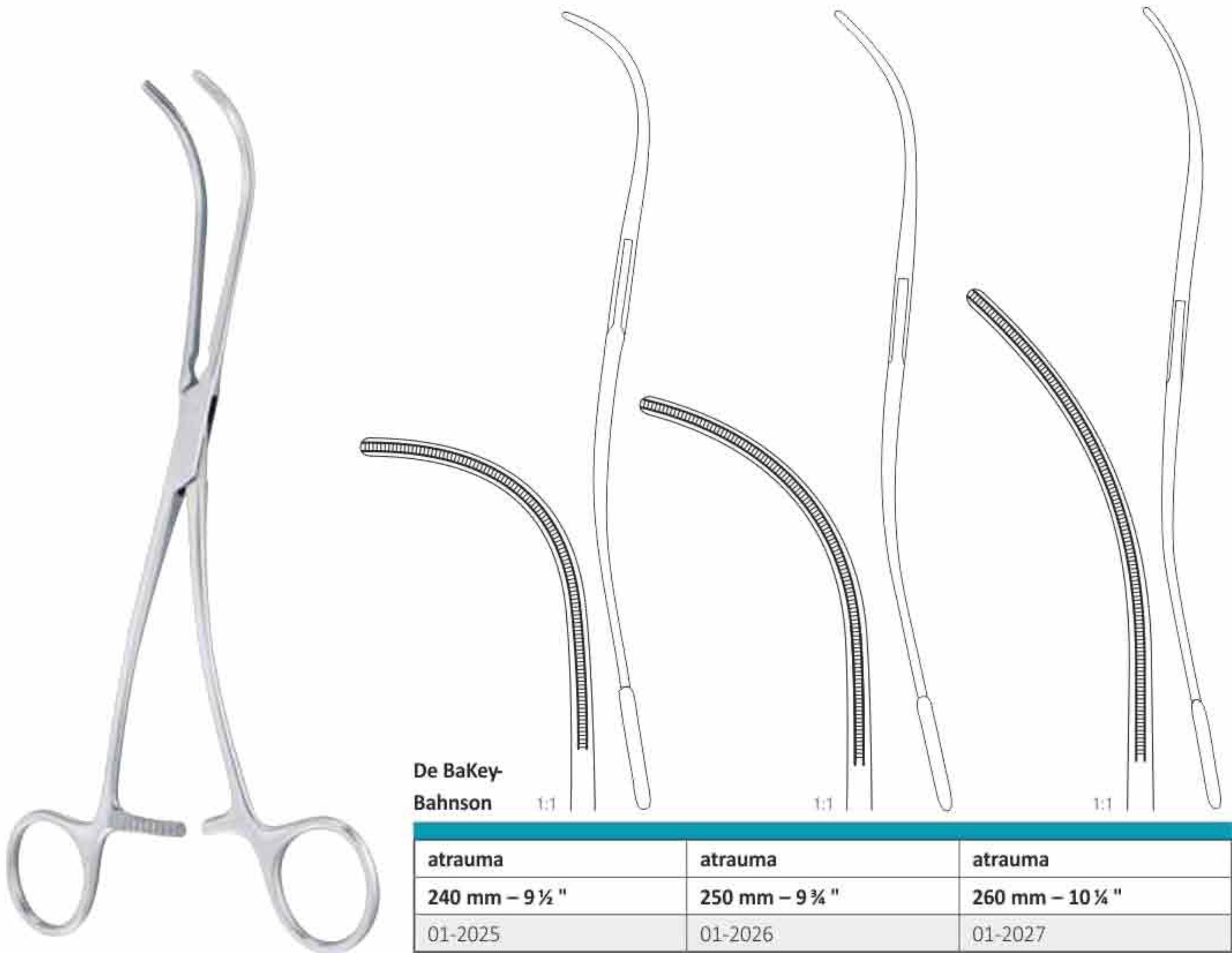

Vascular forceps



De BaKey-semB

	atrauma	atrauma
240 mm – 9 ½ "	01-2028-01	01-2028-02



De BaKey

atrauma	atrauma
250 mm – 10 "	260 mm – 10 ¼ "
01-2029-01	01-2029-02

Vascular forceps

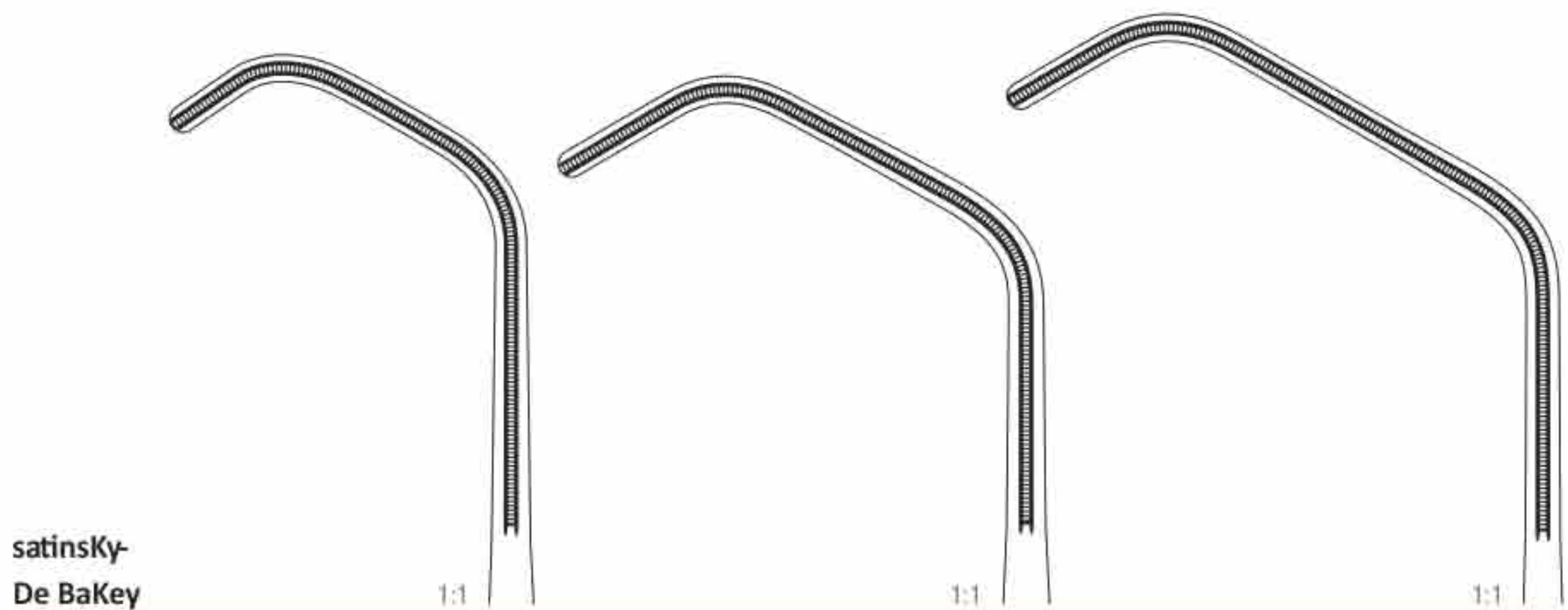

Satinsky-
De BaKey

atrauma	atrauma	atrauma
205 mm – 8"	240 mm – 9 3/4"	250 mm – 10"
01-2030-01	01-2030-02	01-2030-03

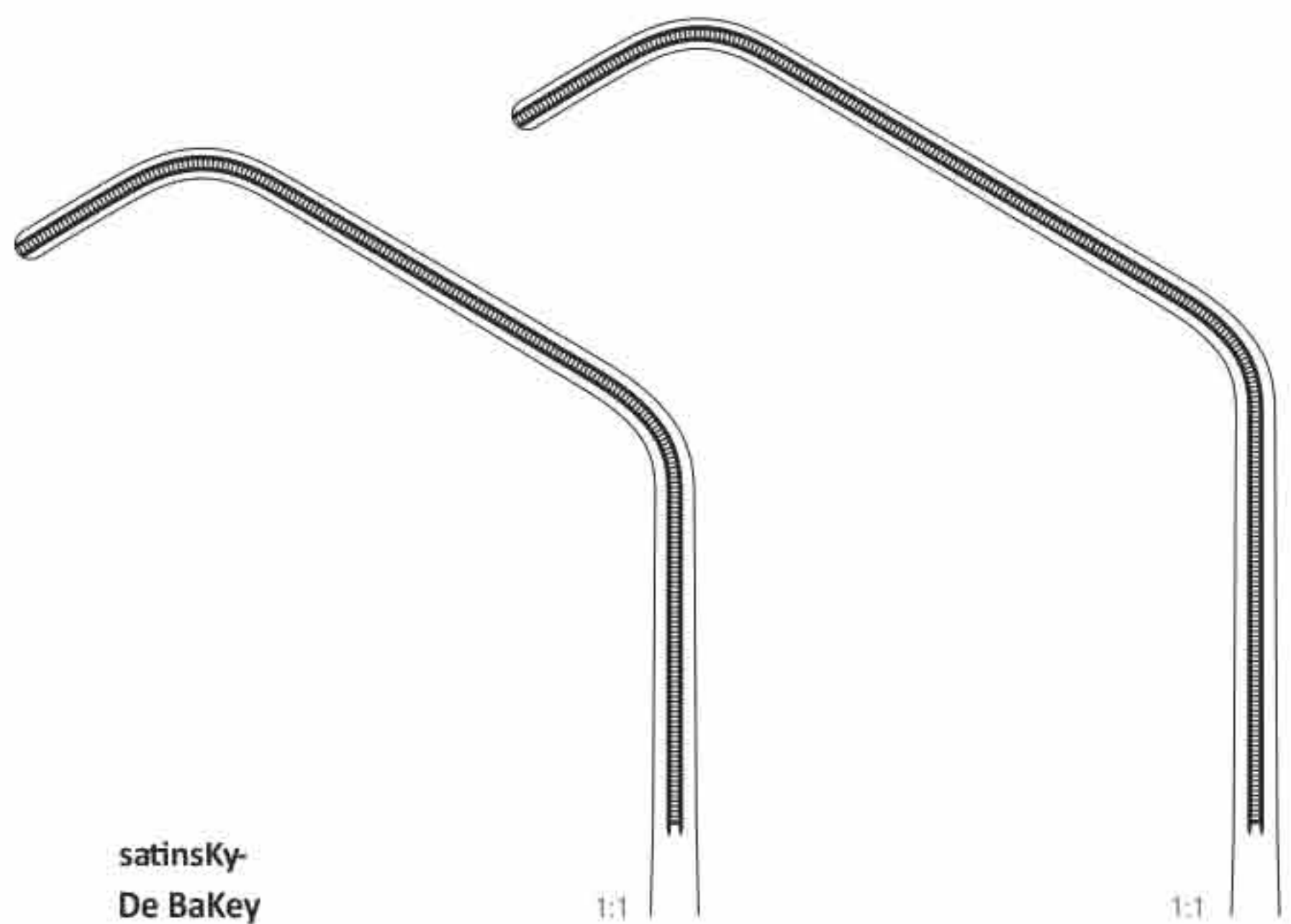

Satinsky-
De BaKey

atrauma	atrauma
265 mm – 10 1/2"	275 mm – 10 3/4"
01-2031-01	01-2031-02

Vascular forceps

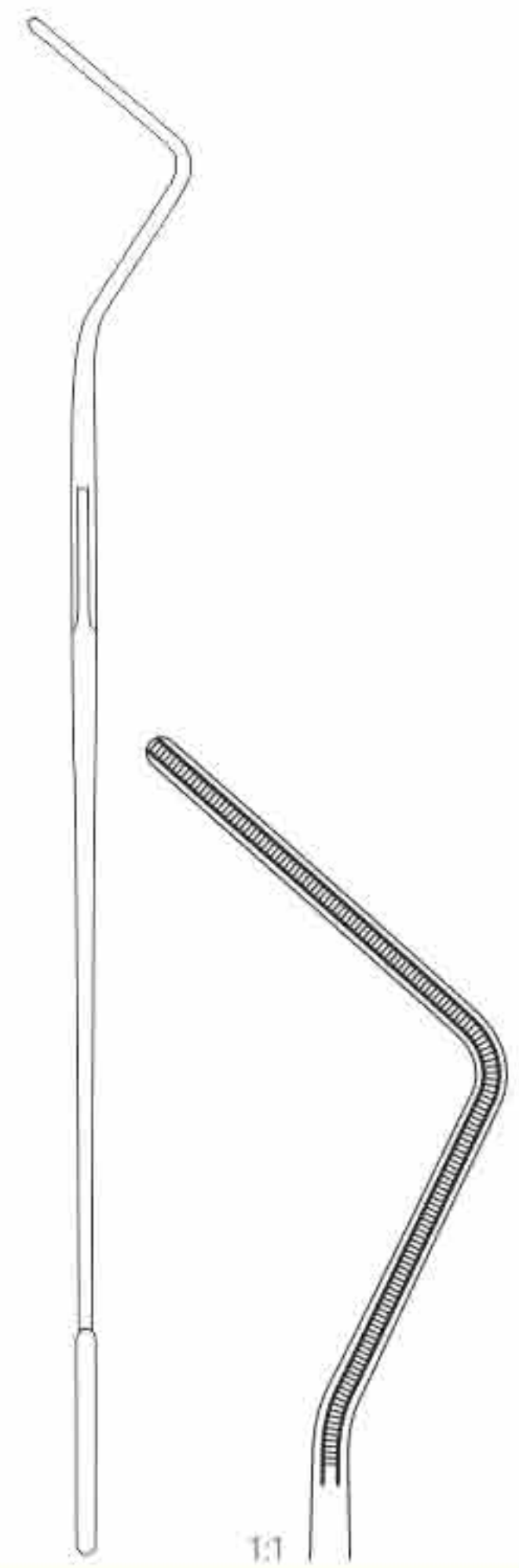
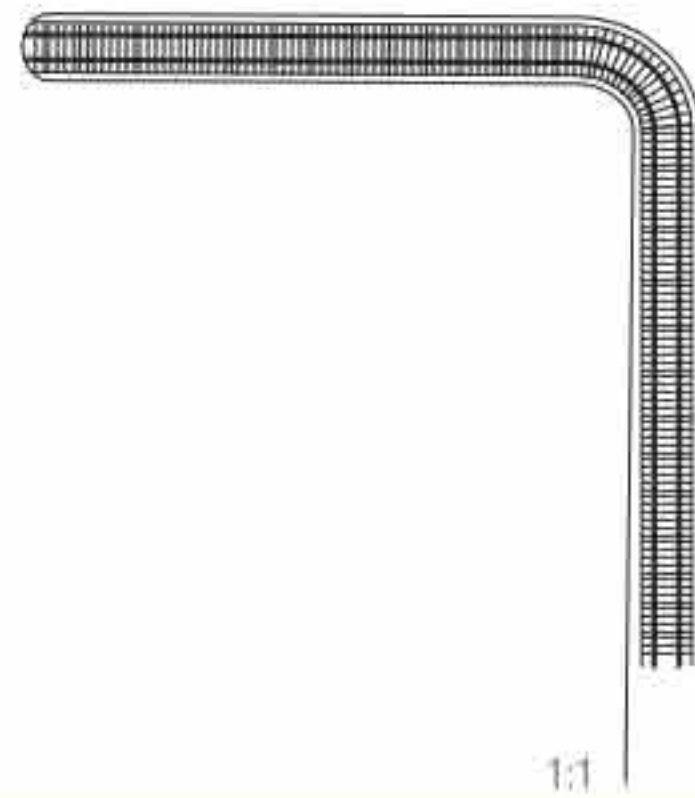
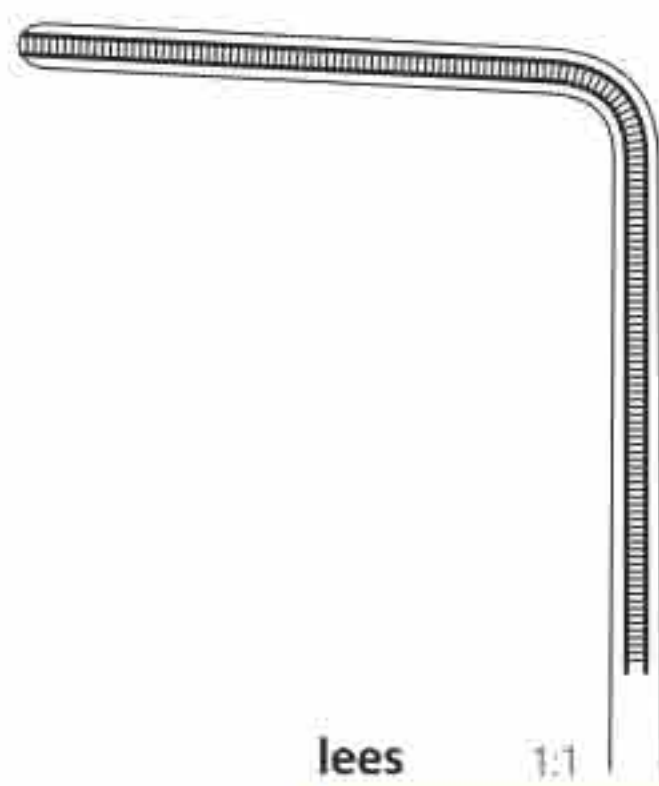

atrauma	atrauma	atrauma
230 mm – 9"	250 mm – 9 ¾"	250 mm – 9 ¾"
01-2032	01-2033	01-2034

Vascular forceps



lamBeRt-Kay

	atrauma	atrauma
200 mm – 8"	01-2035-01	01-2035-02

Vascular forceps

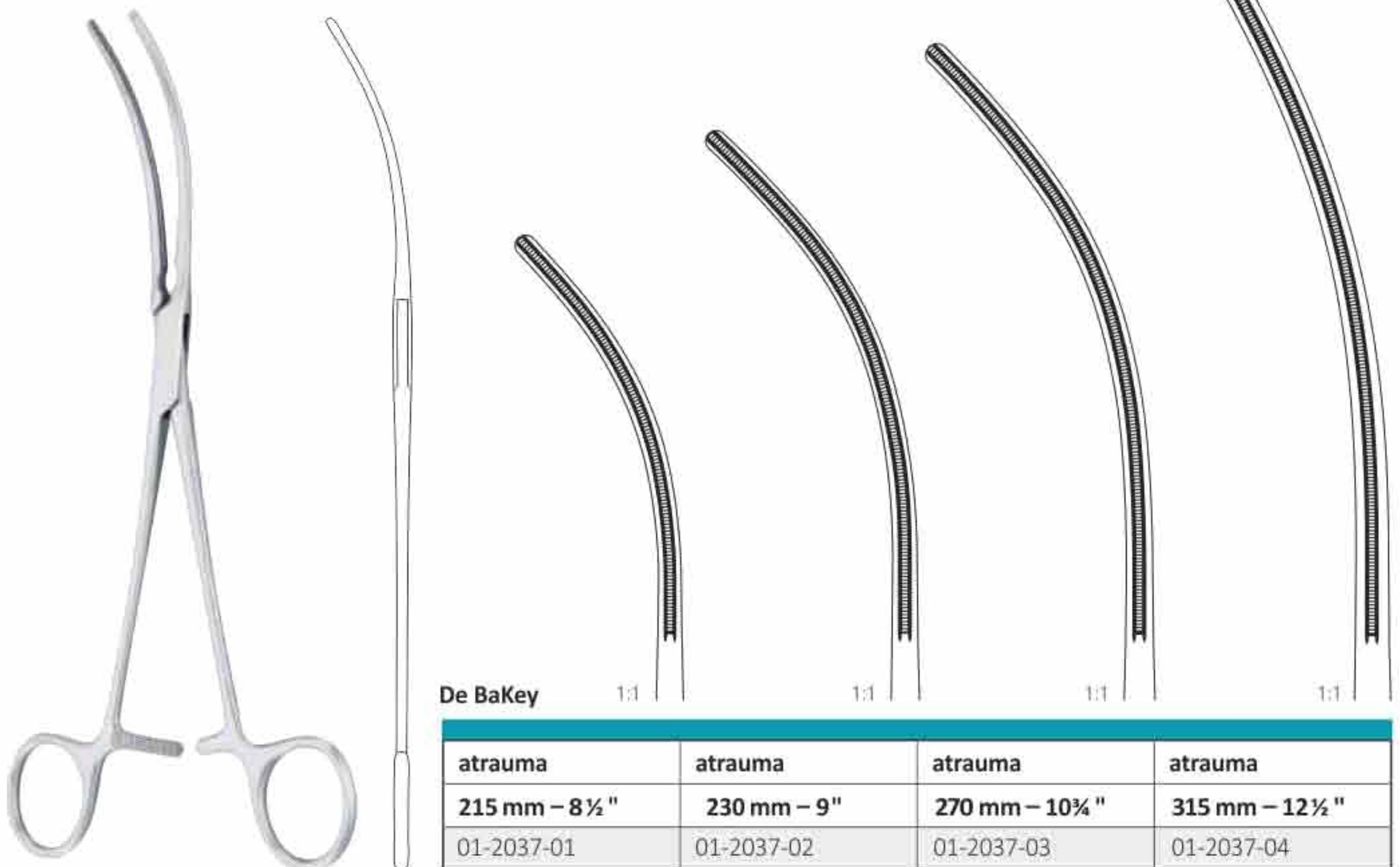
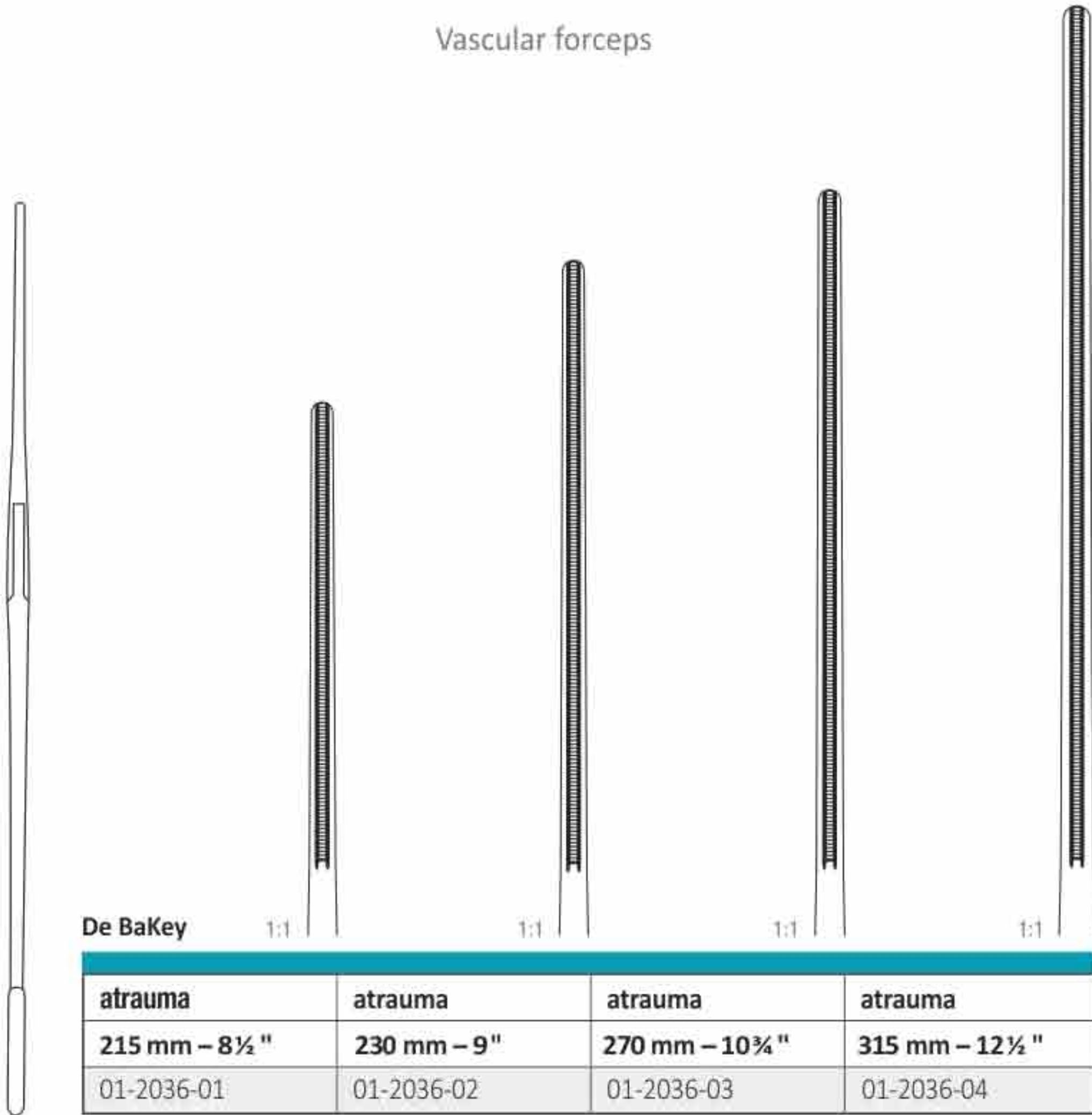

Vascular forceps

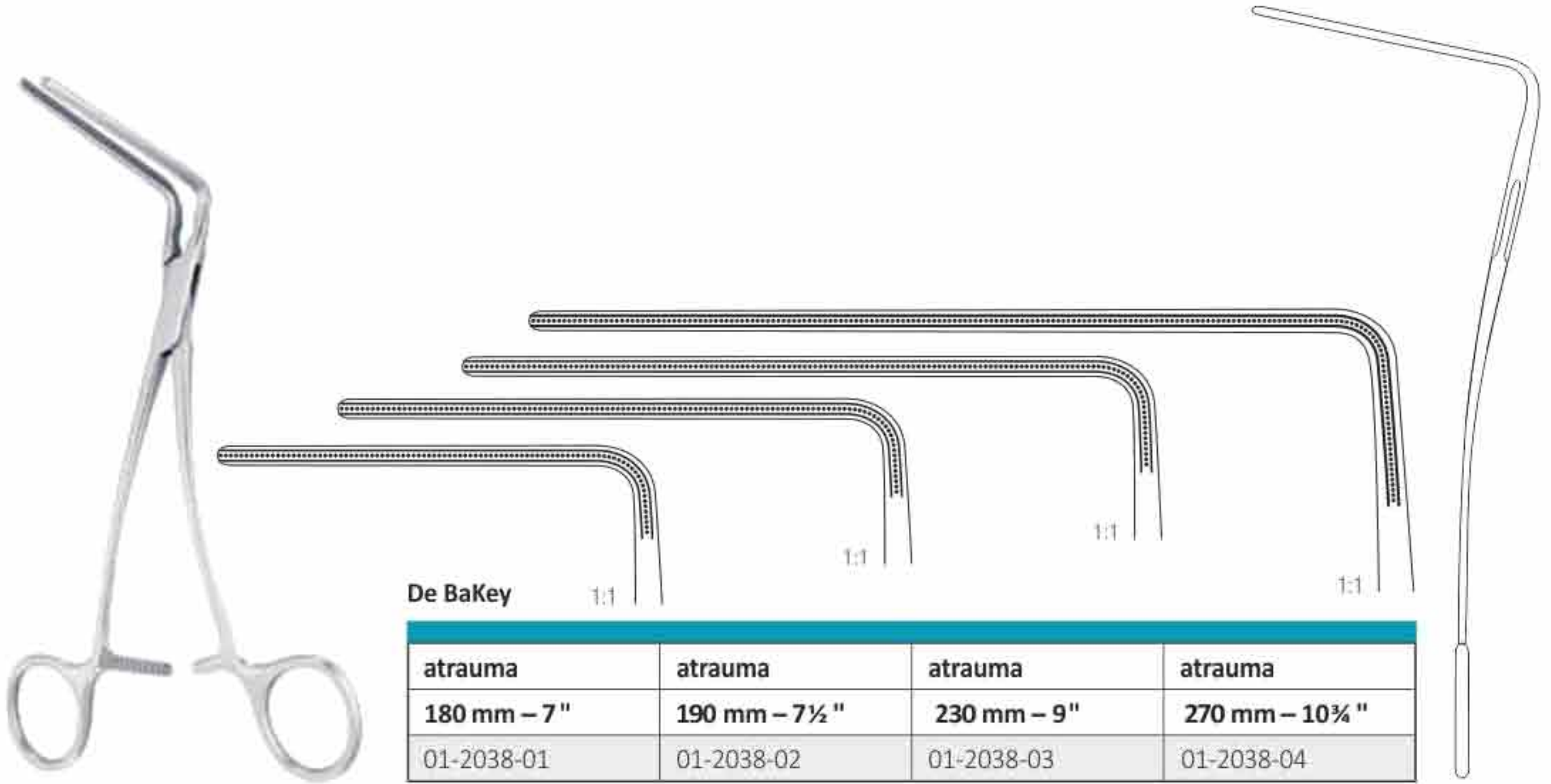

De BaKey

atrauma	atrauma	atrauma	atrauma
180 mm – 7"	190 mm – 7½"	230 mm – 9"	270 mm – 10¾"
01-2038-01	01-2038-02	01-2038-03	01-2038-04

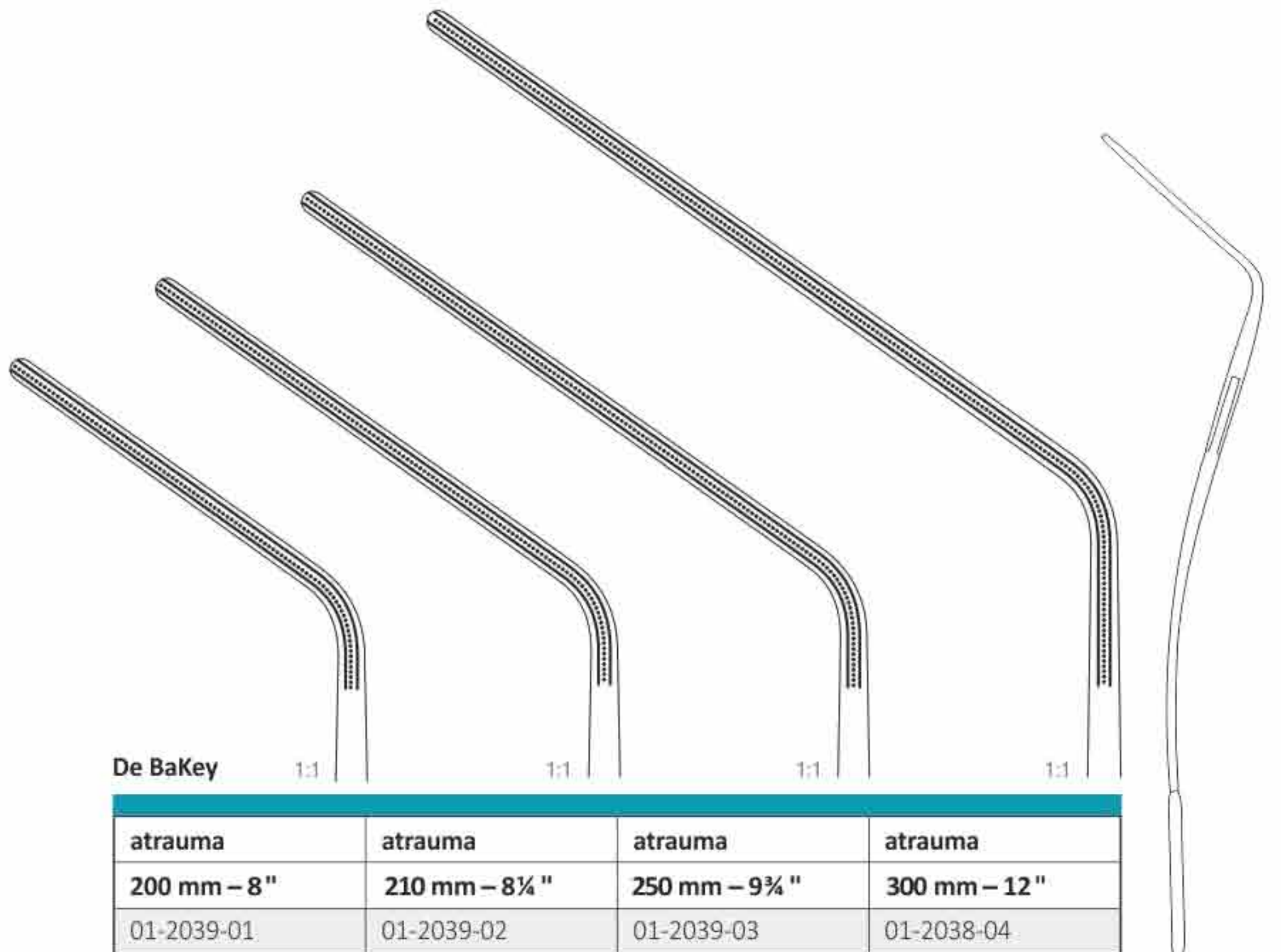

De BaKey

atrauma	atrauma	atrauma	atrauma
200 mm – 8"	210 mm – 8¼"	250 mm – 9¾"	300 mm – 12"
01-2039-01	01-2039-02	01-2039-03	01-2038-04

Vascular forceps

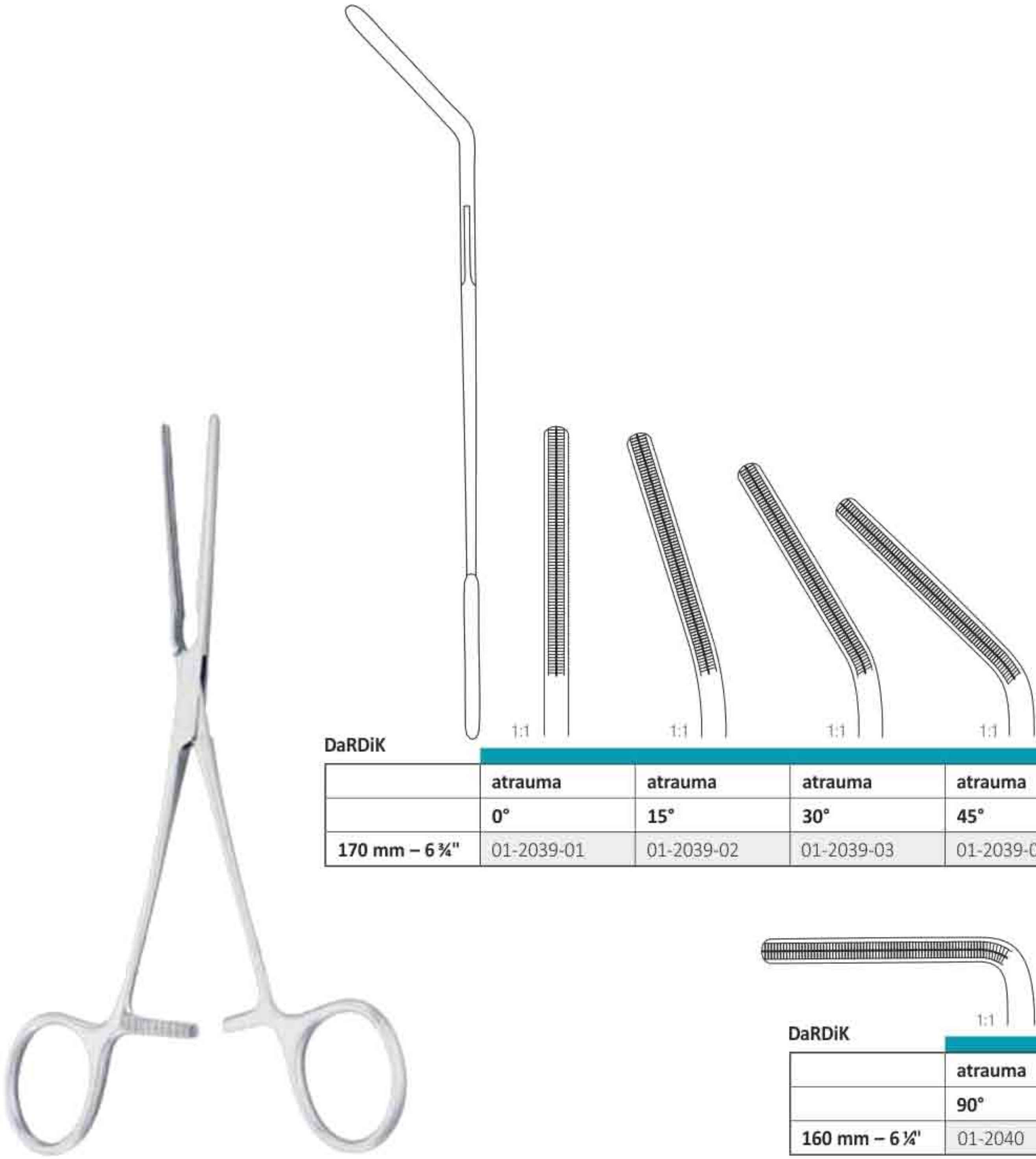

DaRDik

	atrauma	atrauma	atrauma	atrauma
	0°	15°	30°	45°
170 mm - 6 1/4"	01-2039-01	01-2039-02	01-2039-03	01-2039-04

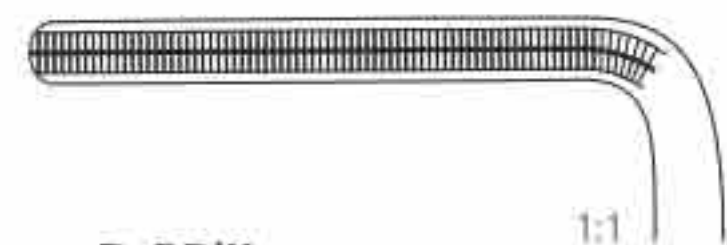

DaRDik

	atrauma
	90°
160 mm - 6 1/4"	01-2040

Vascular forceps

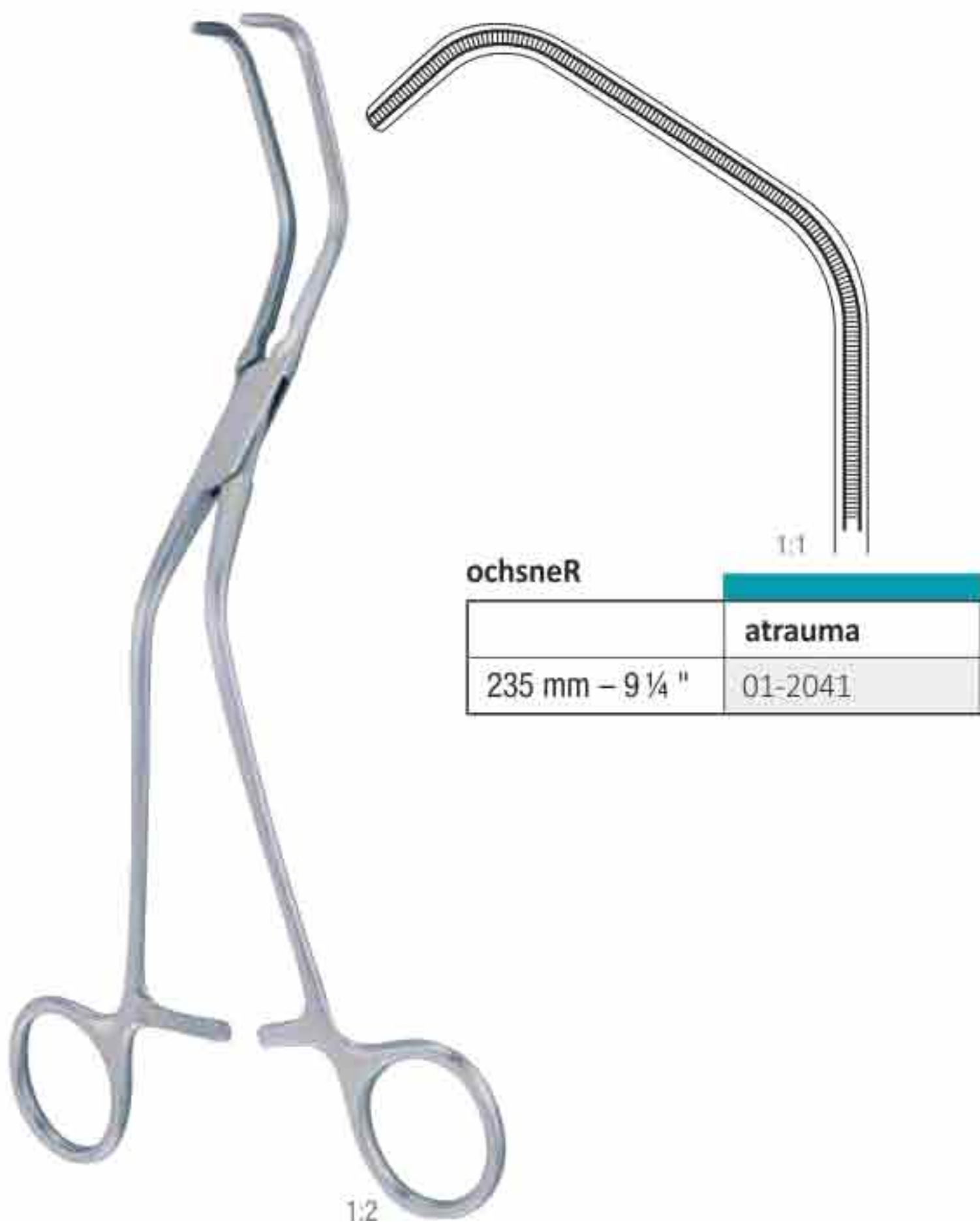

Vascular forceps

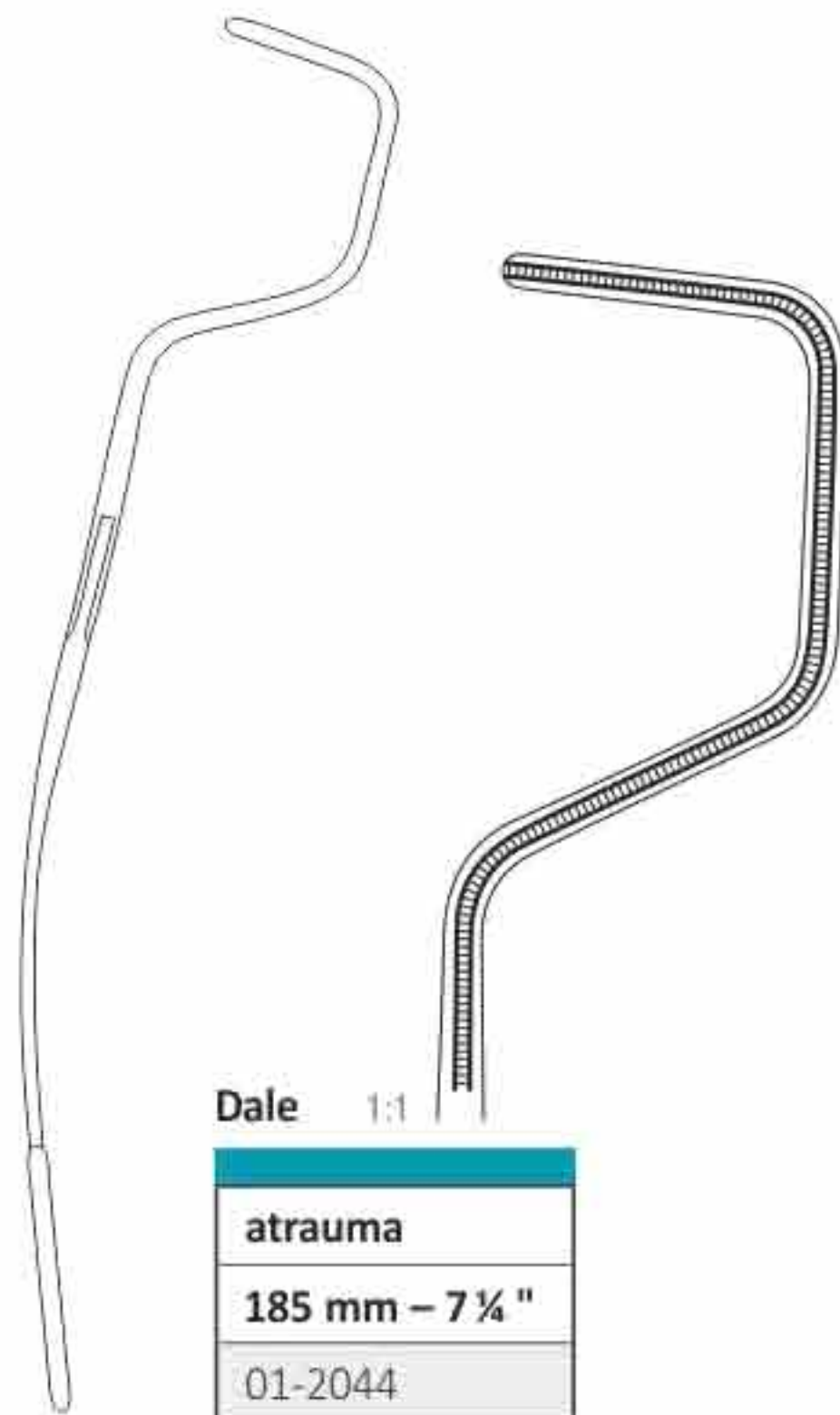
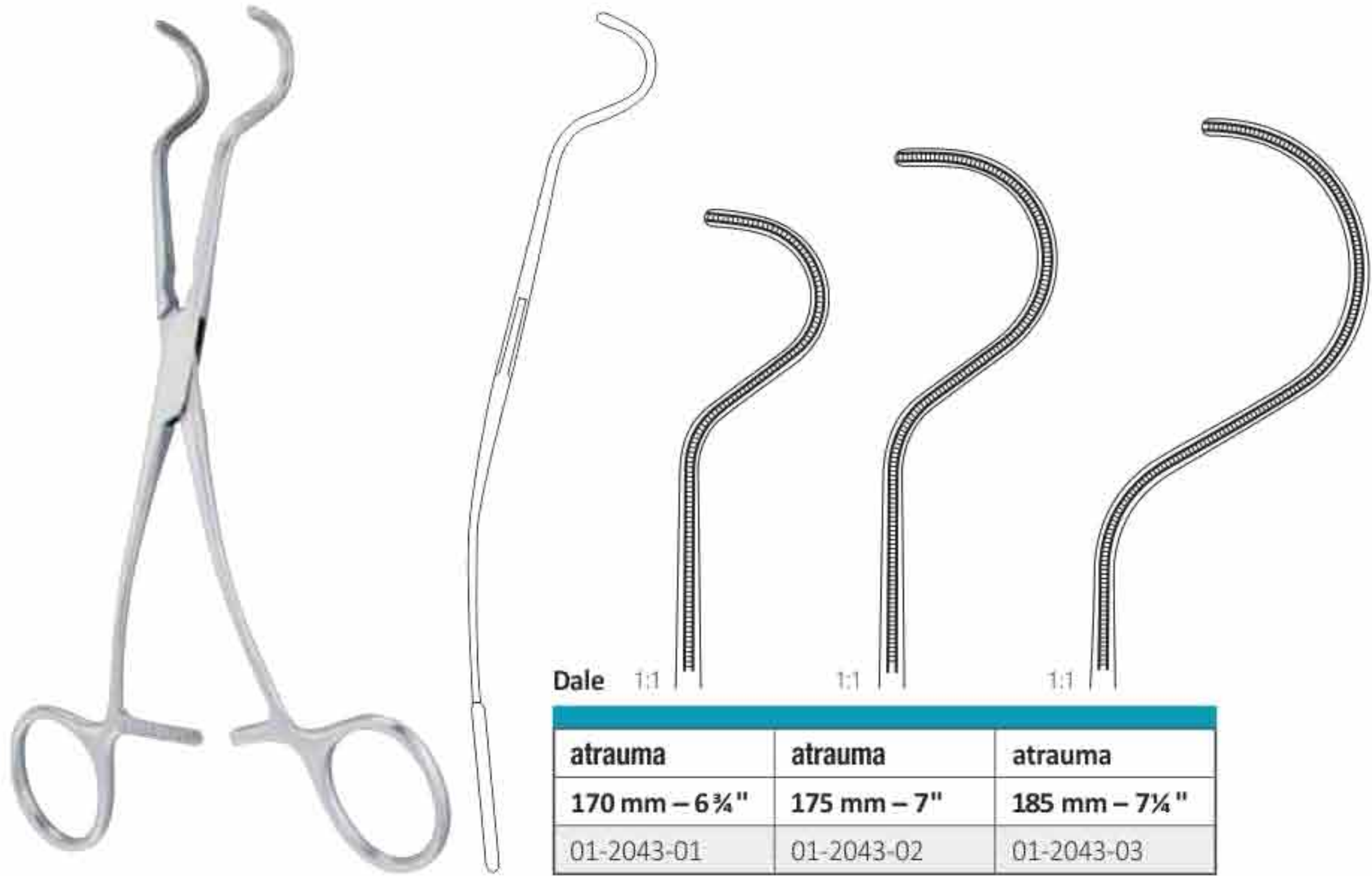

Vascular forceps

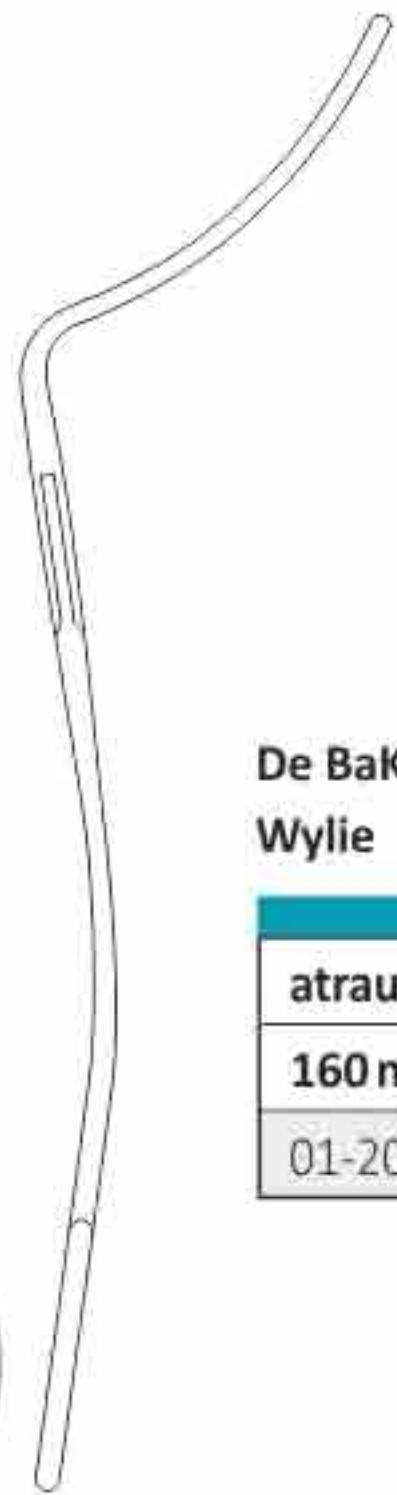

De BaKey-Wylie

1:1

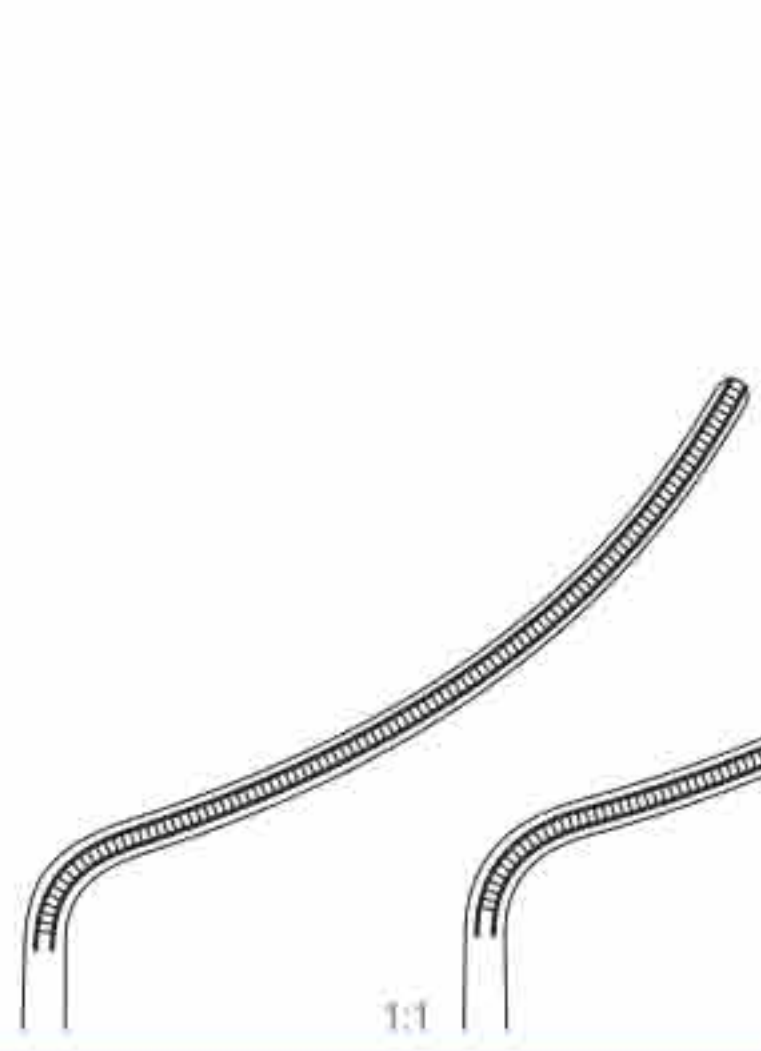

1:1

atrauma	atrauma
160 mm – 6 ¼ "	180 mm – 7 "
01-2045-01	01-2045-02

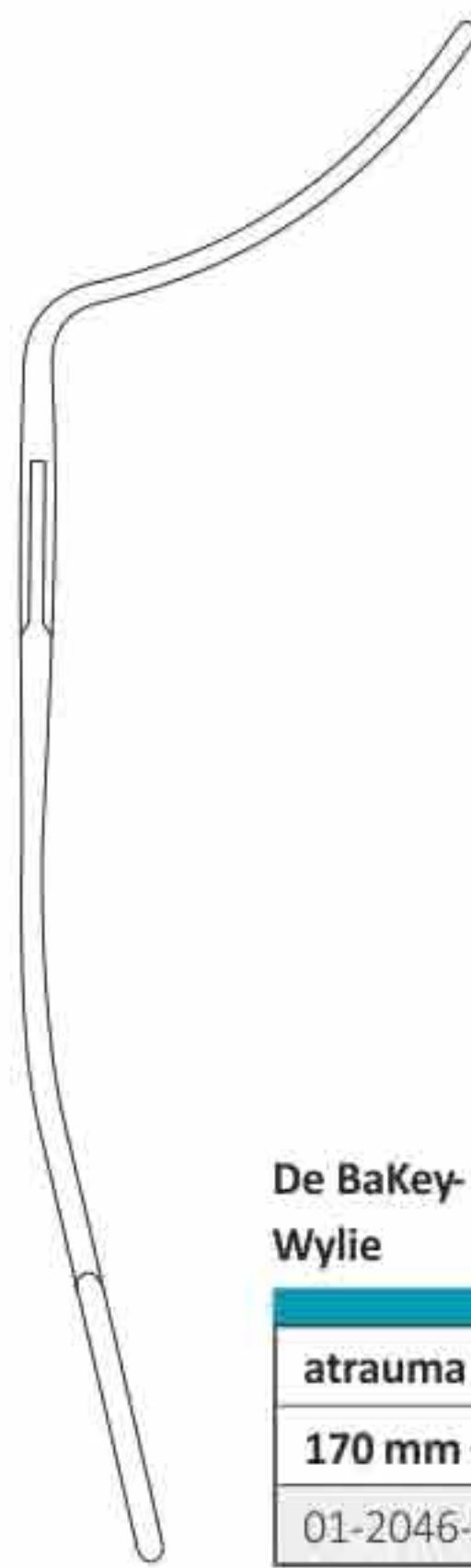

De BaKey-Wylie

1:1

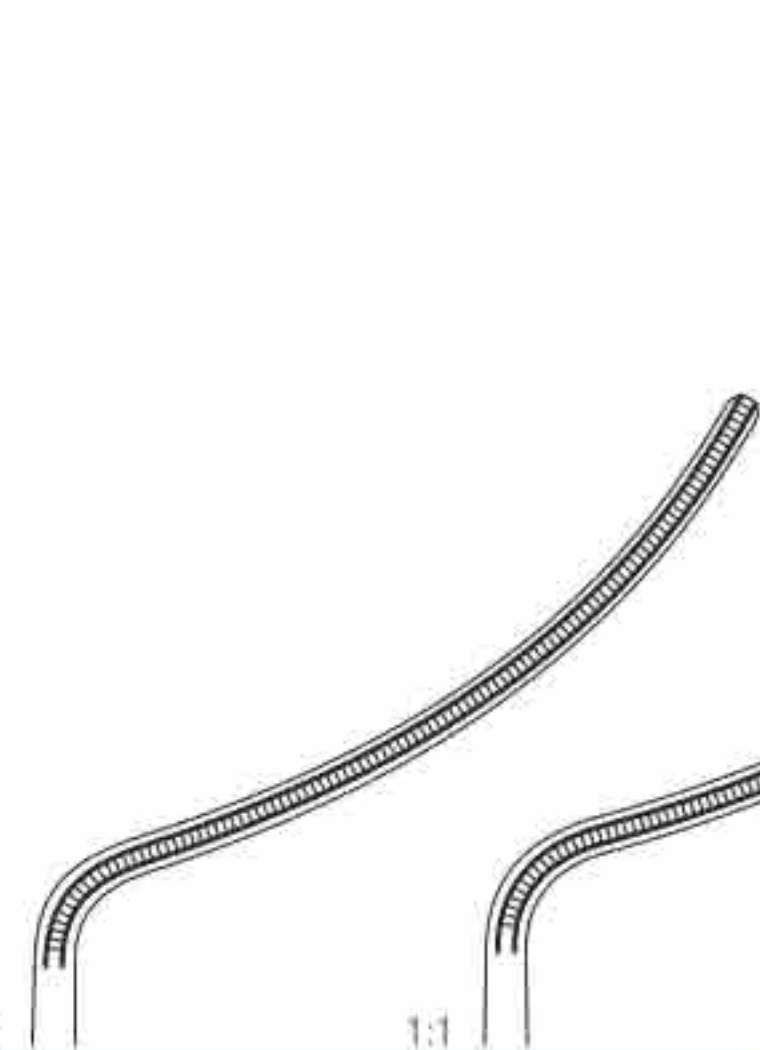

1:1

atrauma	atrauma
170 mm – 6 ¾ "	200 mm – 8 "
01-2046-01	01-2046-02

Vascular forceps



GReGoRy

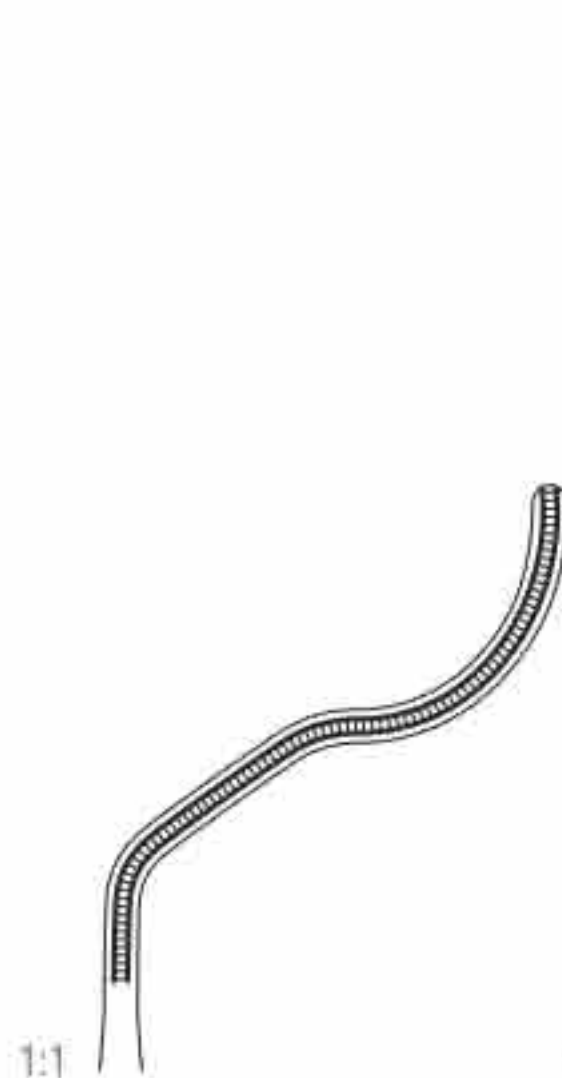

1:1

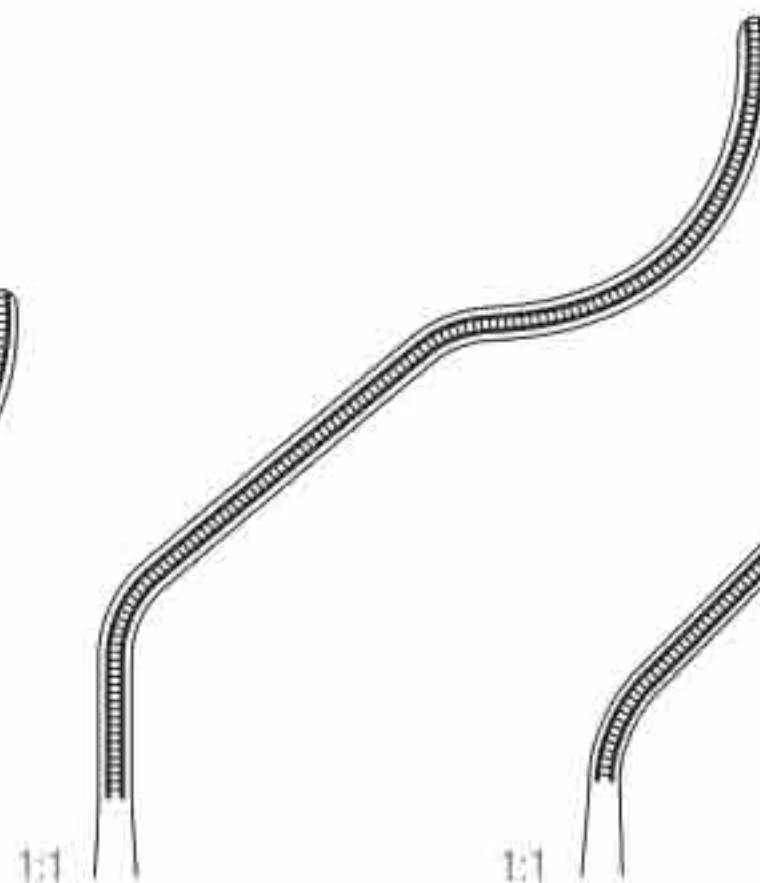

1:1

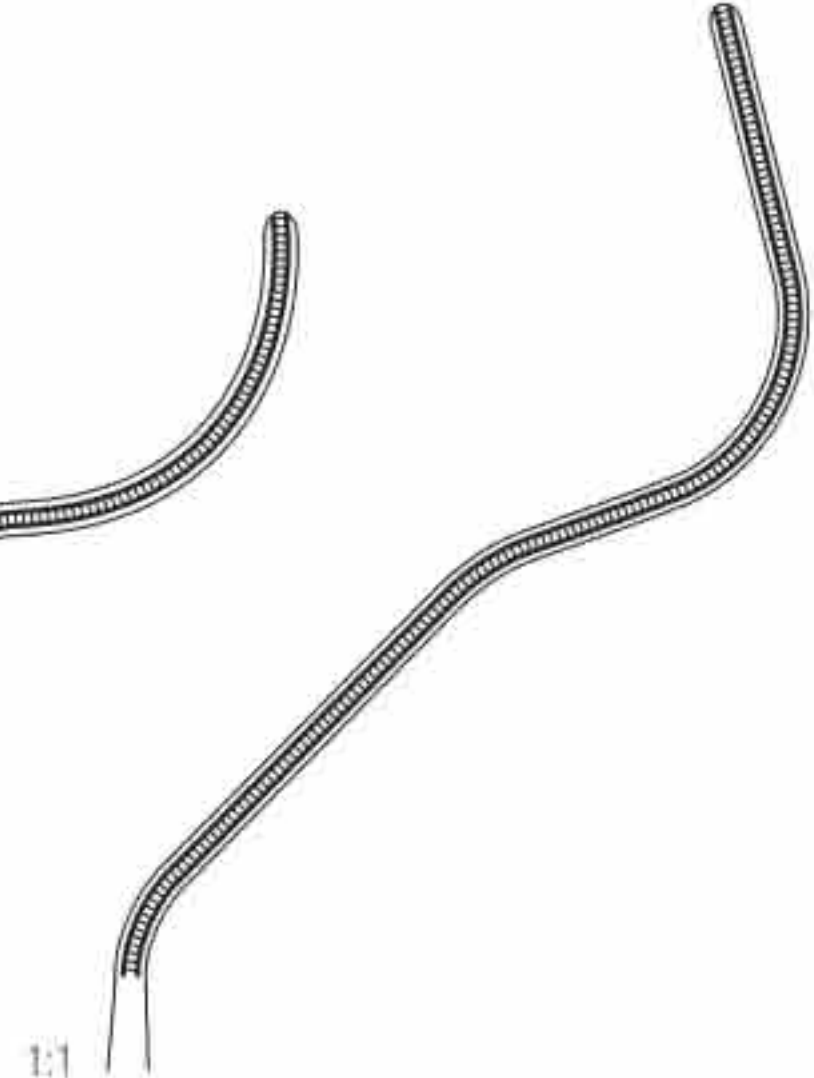

1:1

atrauma	atrauma	atrauma
140 mm – 5 ½ "	160 mm – 6 ¼ "	180 mm – 7 "
01-2047-01	01-2047-02	01-2047-03



JaviD



1:1

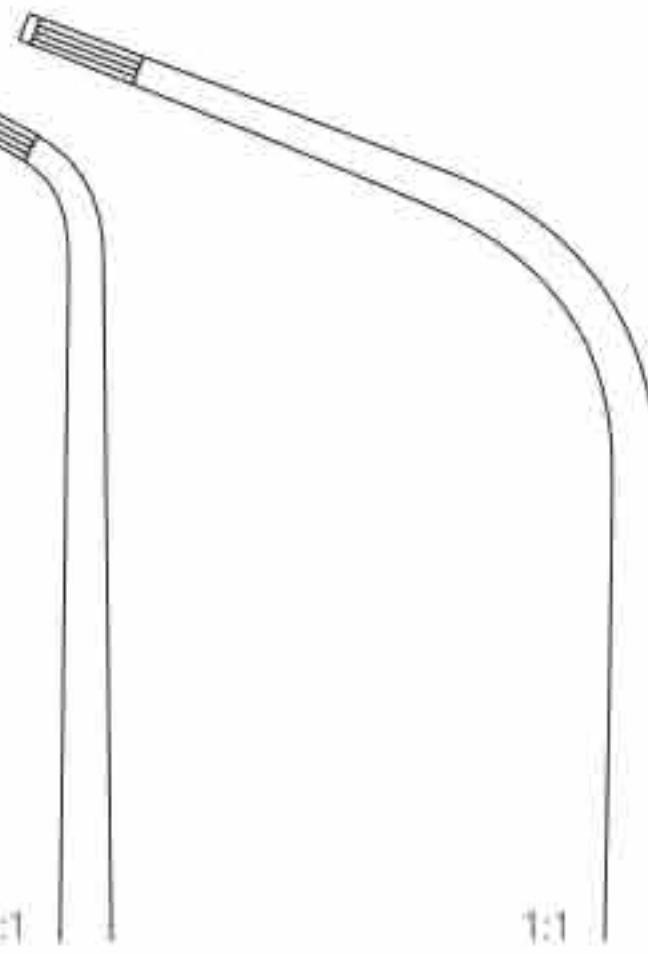

1:1

atrauma	atrauma
160 mm – 6 ¼ "	190 mm – 7 ½ "
01-2048-01	01-2048-02

Vascular forceps

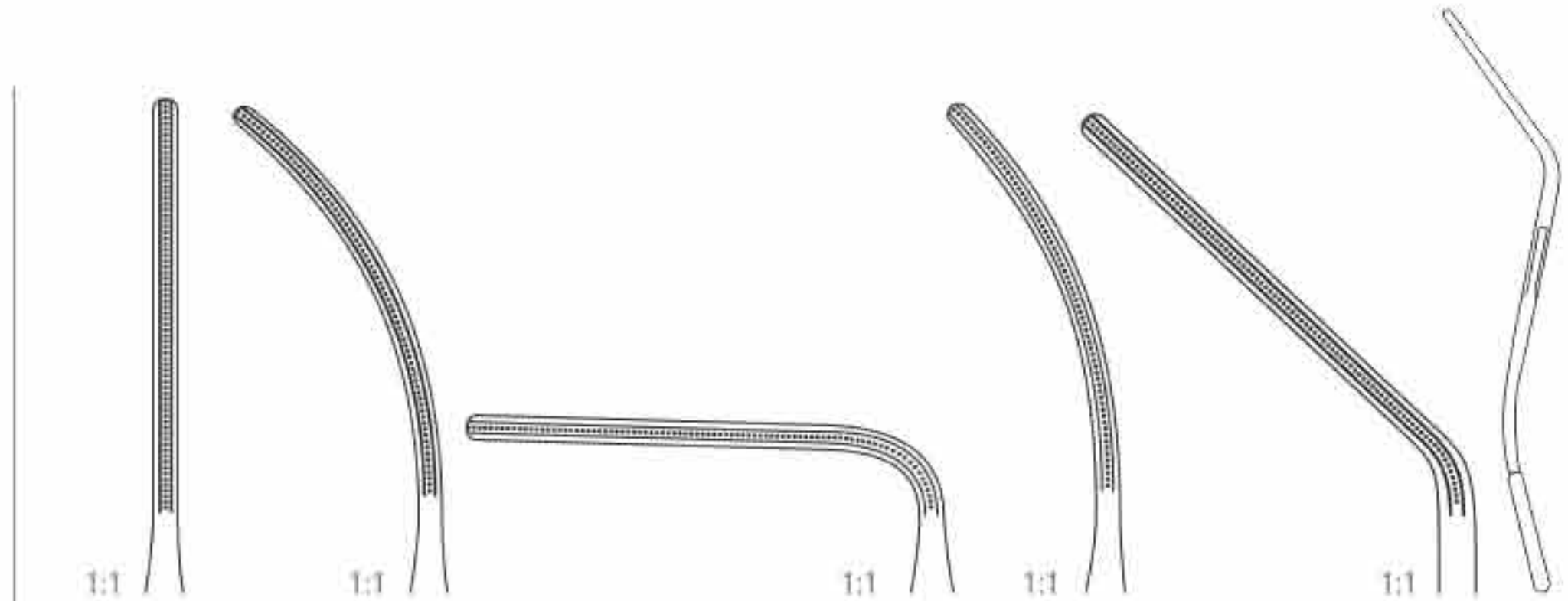

De BaKey

atrauma	atrauma	atrauma	atrauma	atrauma
120 mm – 4 ¾"	110 mm – 4 ¼"	100 mm – 4"	120 mm – 4 ¾"	130 mm – 5"
01-2049	01-2050	01-2051	01-2052	01-2053

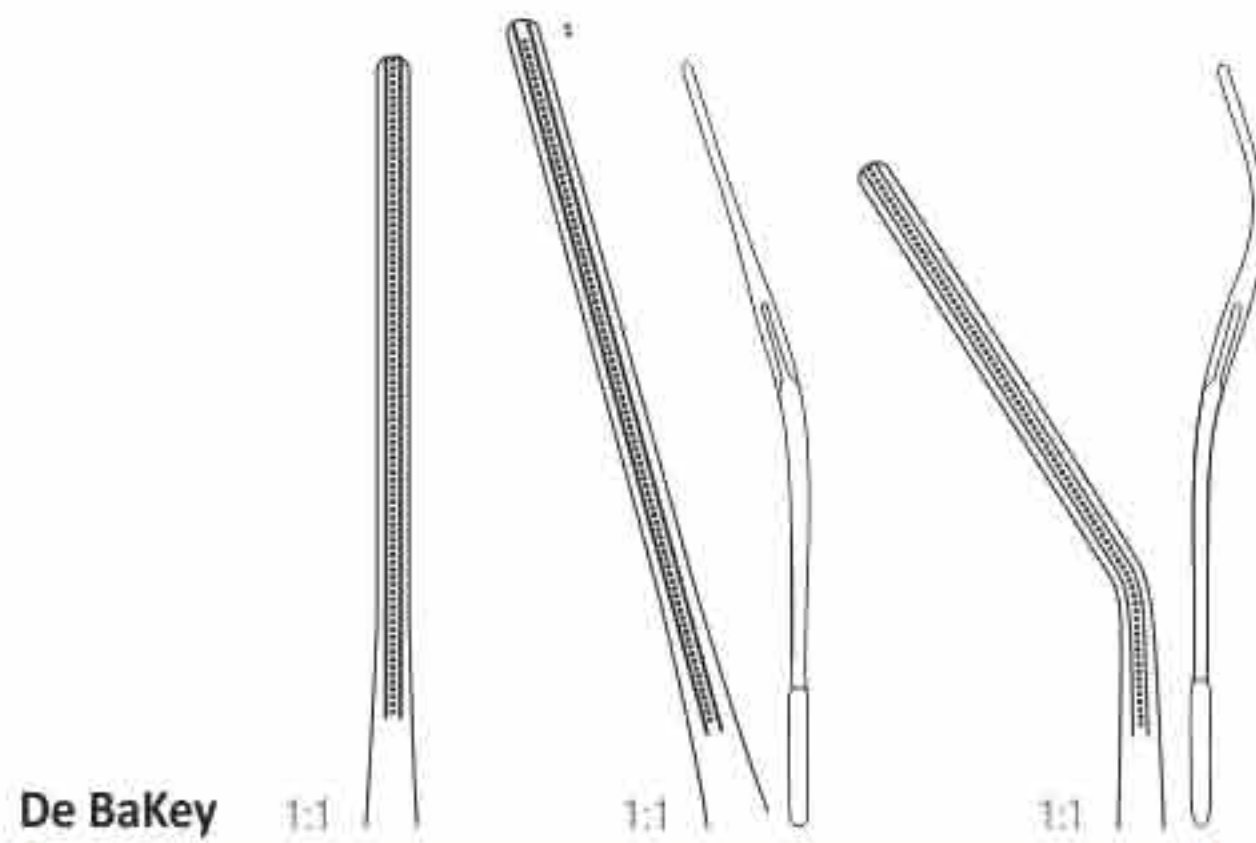

De BaKey

atrauma	atrauma	atrauma
170 mm – 6 ¾"	170 mm – 6 ¾"	160 mm – 6 ¼"
01-2054	01-2055	01-2056

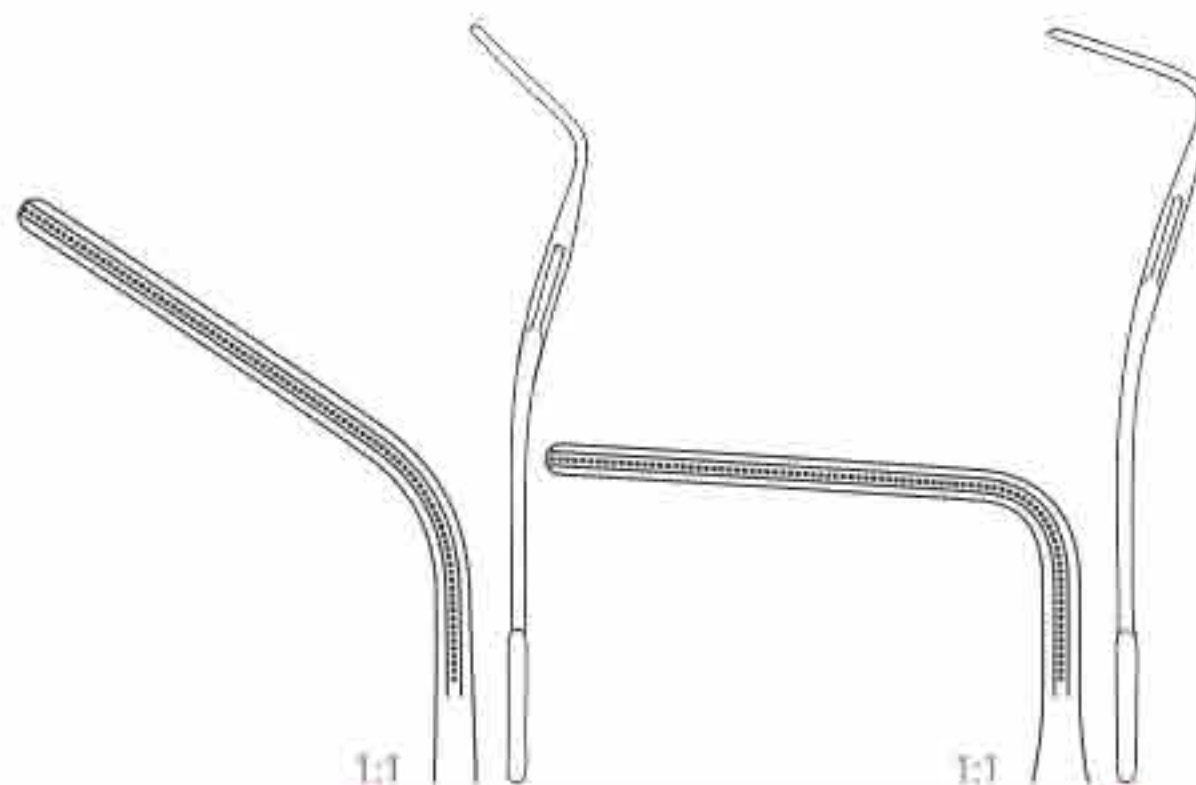

atrauma	atrauma
150 mm – 6"	140 mm – 5 ½"
01-2057	01-2058

Vascular forceps



GloveR

1:1



1:1

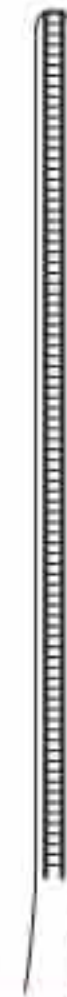

1:1



atrauma	atrauma	atrauma
205 mm – 8"	220 mm – 8¾"	260 mm – 10¼"
01-2059-01	01-2059-02	01-2059-03

GloveR

1:1



1:1

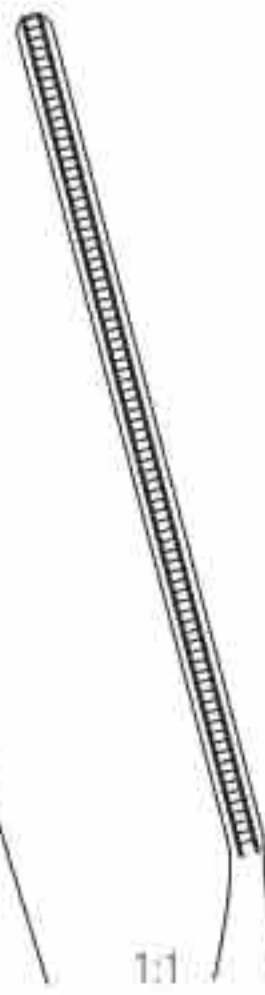

1:1

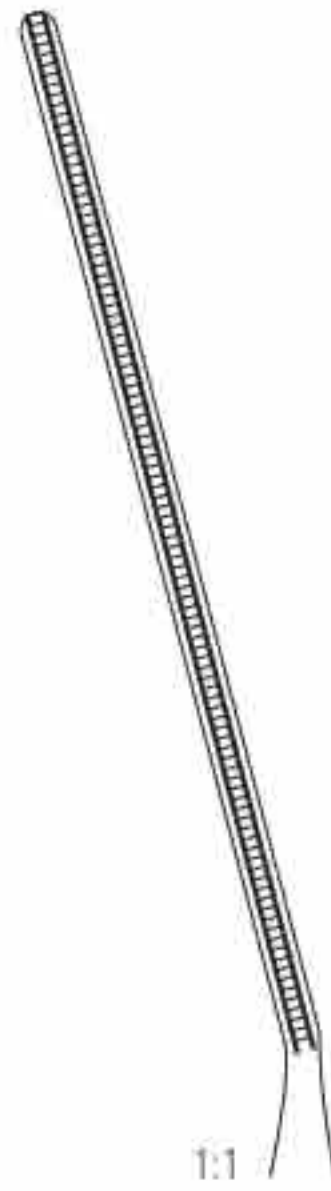

atrauma	atrauma	atrauma
205 mm – 8"	220 mm – 8¾"	260 mm – 10¼"
01-2060-01	01-2060-02	01-2060-03

angled on flat

angled on flat

angled on flat

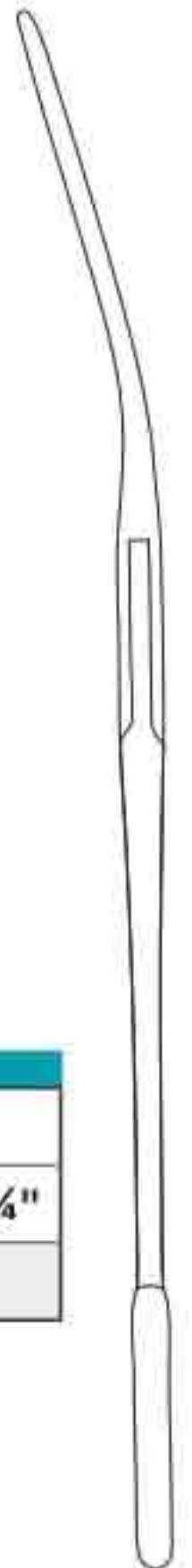

Vascular forceps

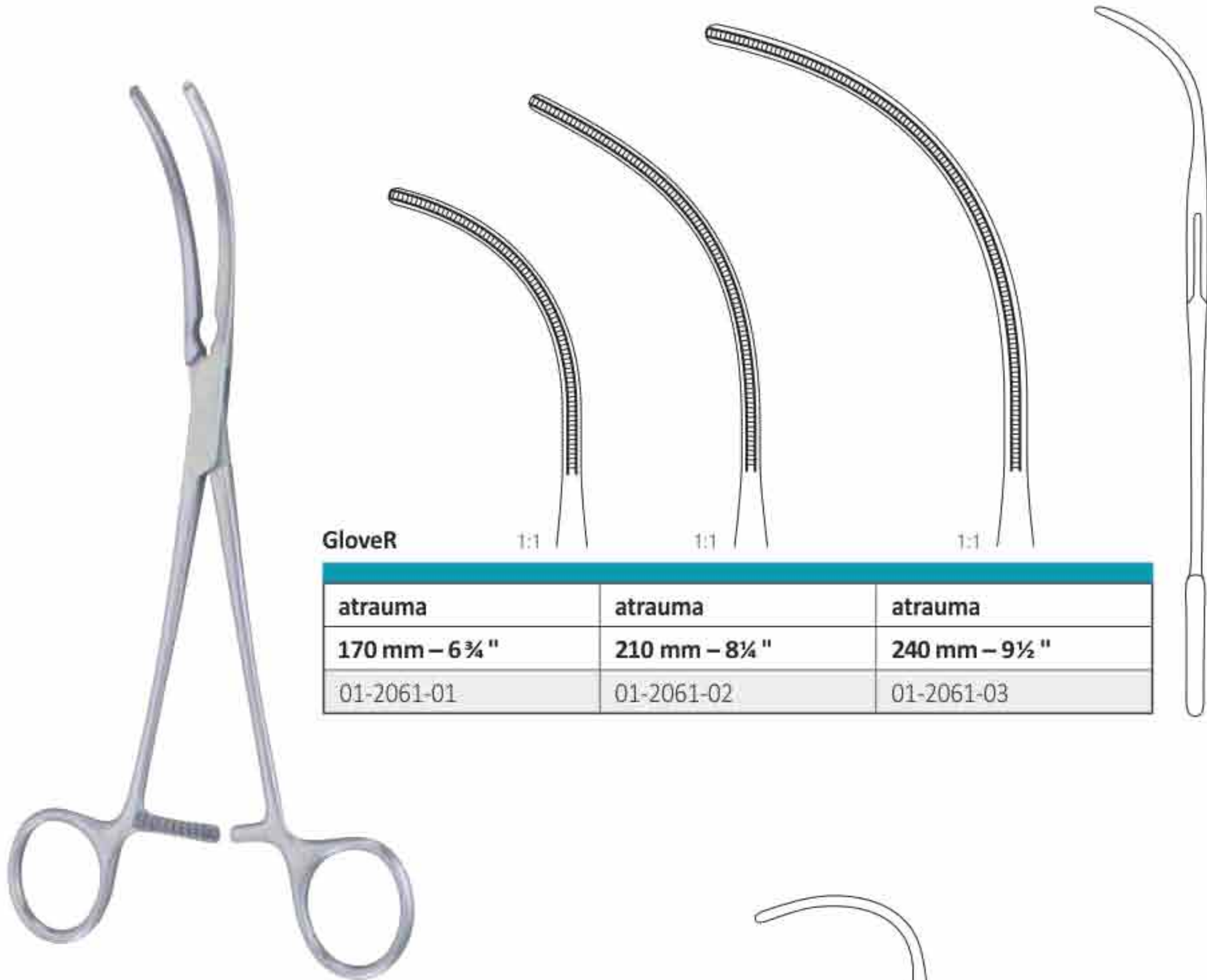

GloveR

1:1

1:1

1:1

atrauma	atrauma	atrauma
170 mm – 6 ¾ "	210 mm – 8 ¼ "	240 mm – 9 ½ "
01-2061-01	01-2061-02	01-2061-03

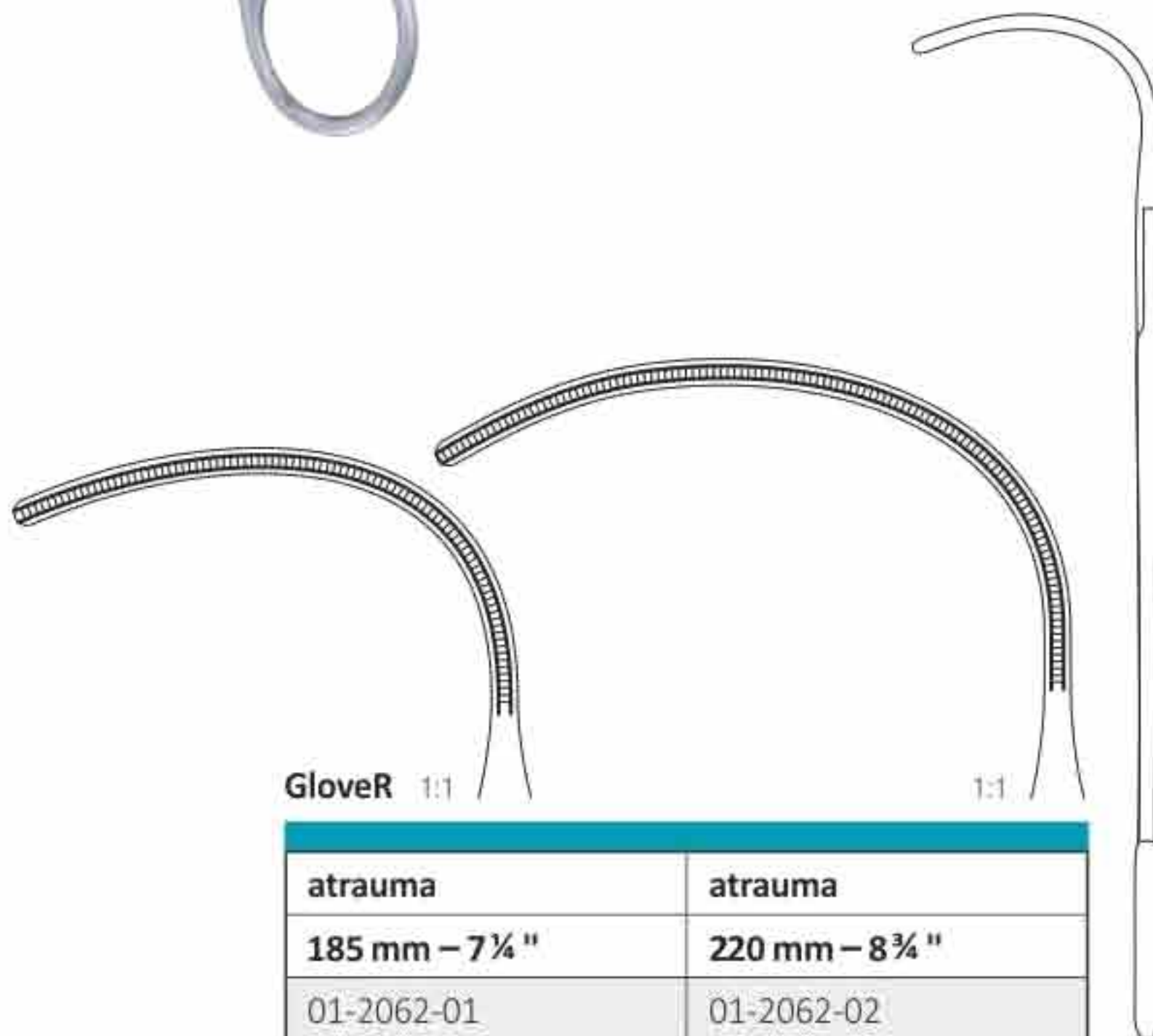

GloveR

1:1

1:1

atrauma	atrauma
185 mm – 7 ¼ "	220 mm – 8 ¾ "
01-2062-01	01-2062-02

Vascular forceps

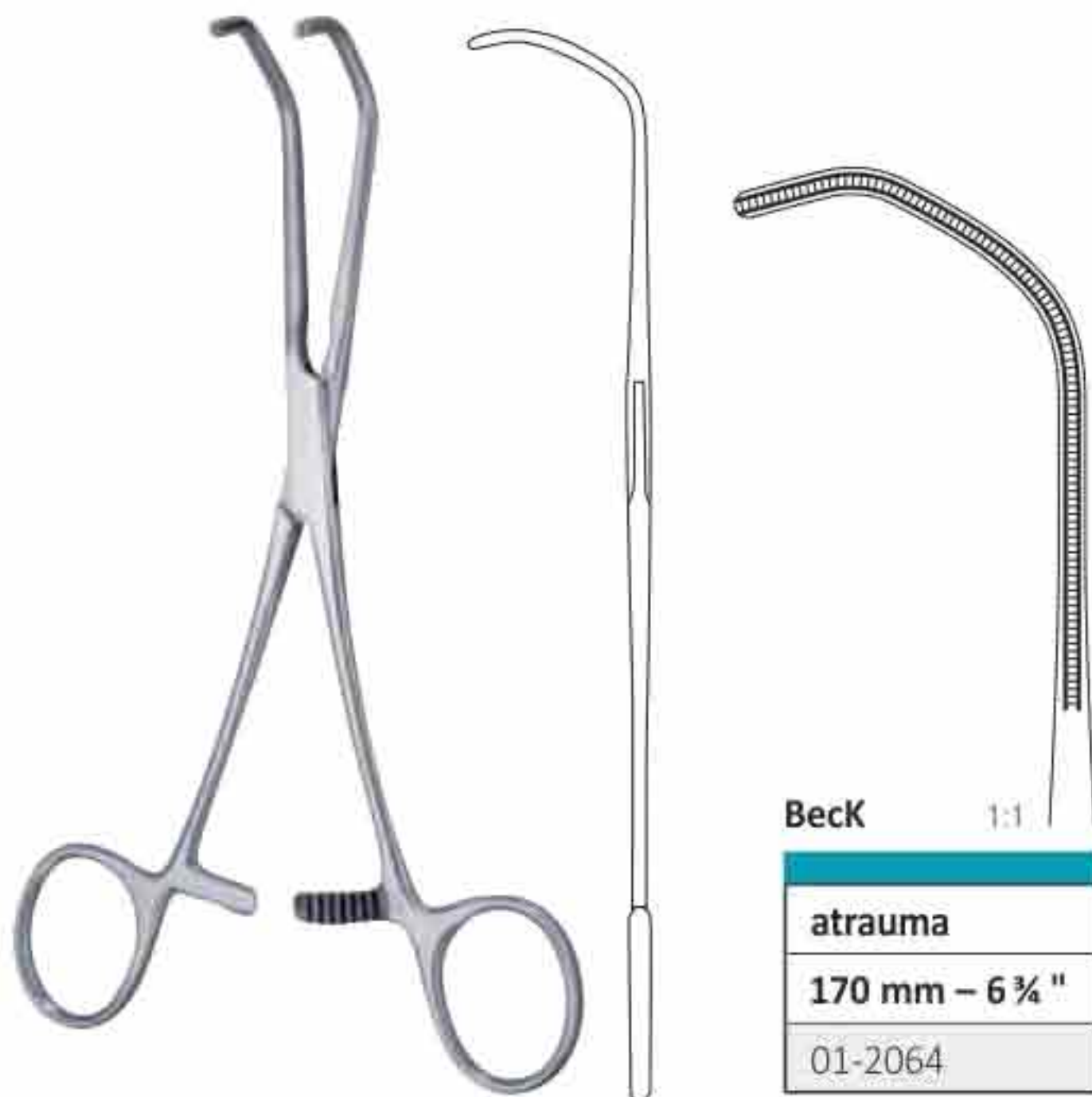
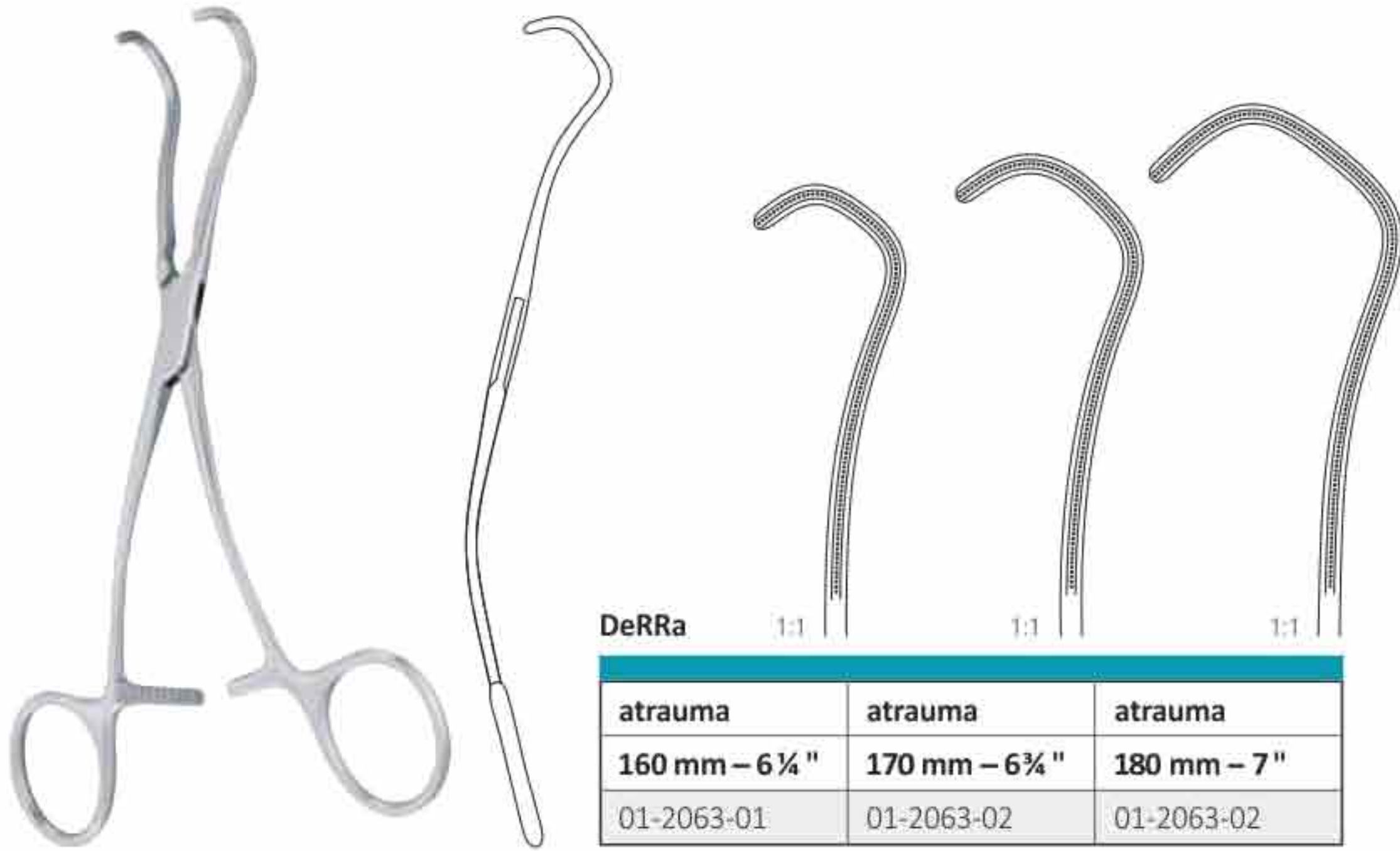

Neonatal and children's clamps, extra delicate patterns

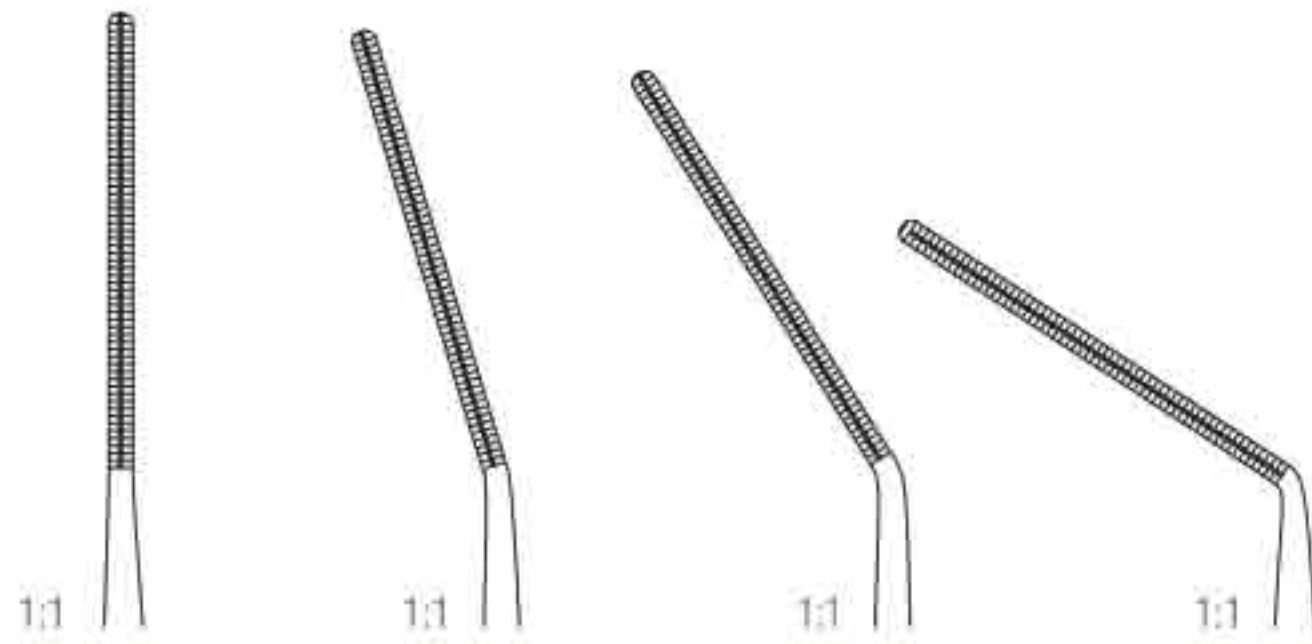

	atrauma	atrauma	atrauma	atrauma
	Fig. 1	Fig. 2	Fig. 3	Fig. 4
115 mm – 4 ½"	01-2065-01	01-2065-02	01-2065-03	01-2065-04
145 mm – 5 ¾"	01-2066-01	01-2066-02	01-2066-03	01-2066-04

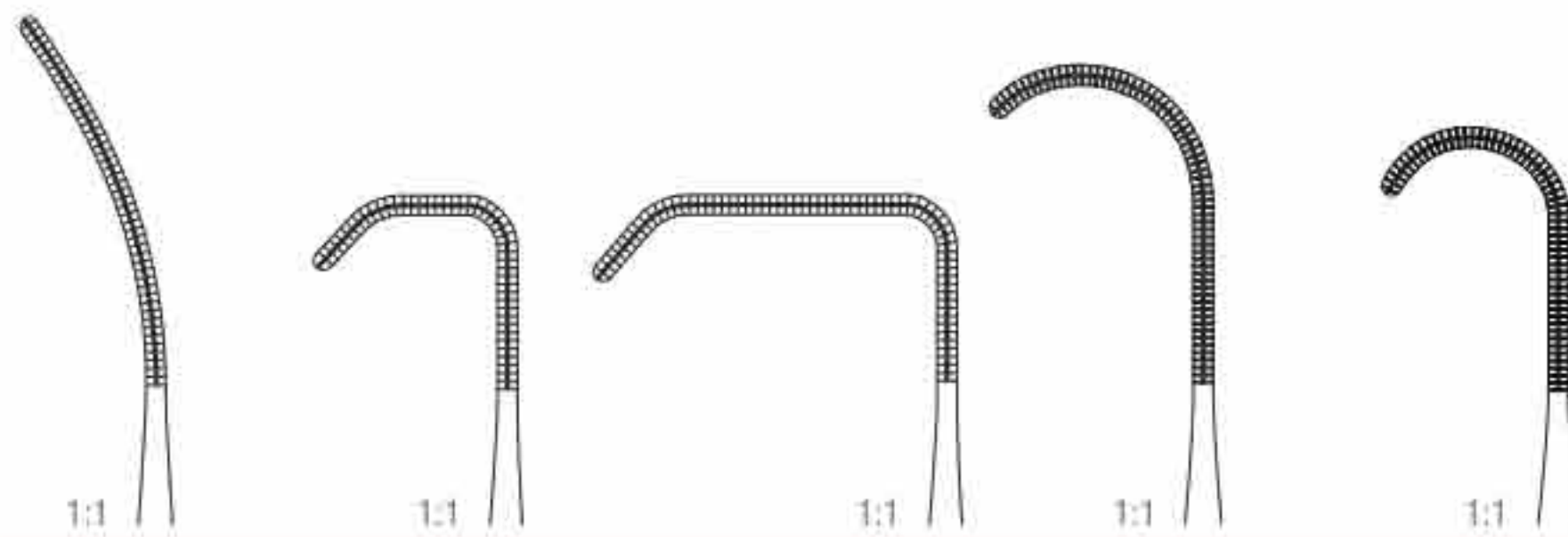

	atrauma	atrauma	atrauma	atrauma	atrauma
	Fig. 5	Fig. 6	Fig. 7	Fig. 8	Fig. 9
115 mm – 4 ½"	01-2067-01	01-2067-02	01-2067-03	01-2067-04	01-2067-05
145 mm – 5 ¾"	01-2068-01	01-2068-02	01-2068-03	01-2068-04	01-2068-05

Neonatal and children's clamps, extra delicate patterns

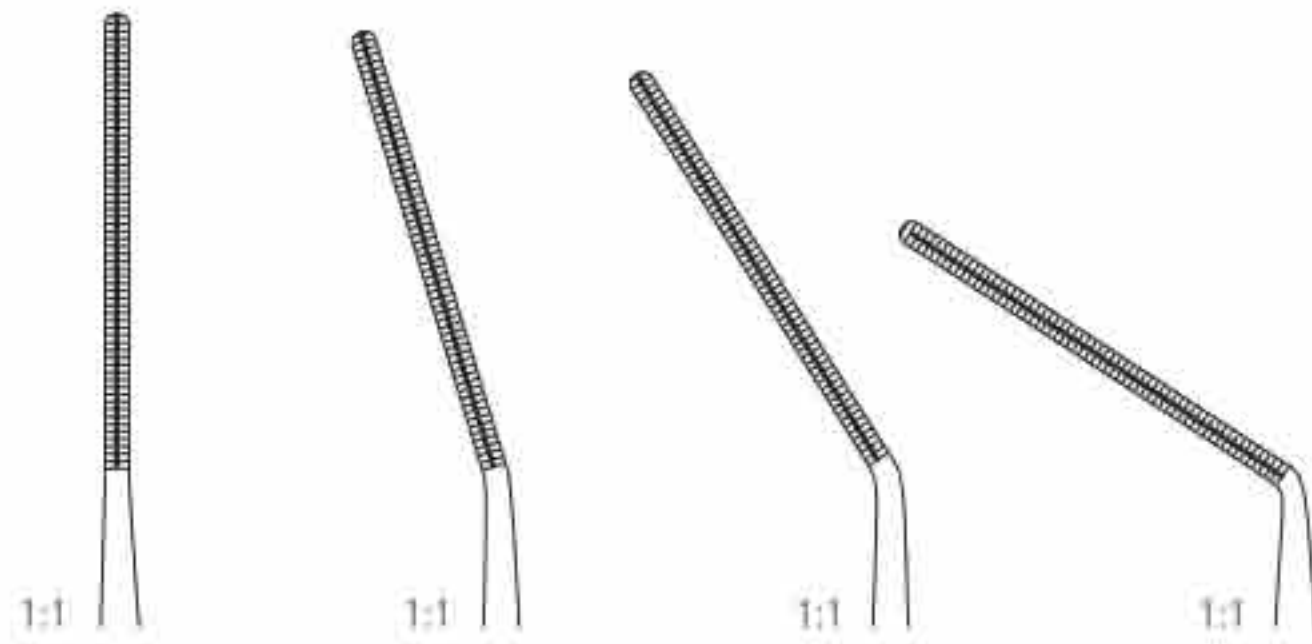

	atrauma	atrauma	atrauma	atrauma
	Fig. 1	Fig. 2	Fig. 3	Fig. 4
115 mm – 4 ½"	01-2069-01	01-2069-02	01-2069-03	01-2069-04
145 mm – 5 ¾"	01-2070-01	01-2070-02	01-2070-03	01-2070-04

curved

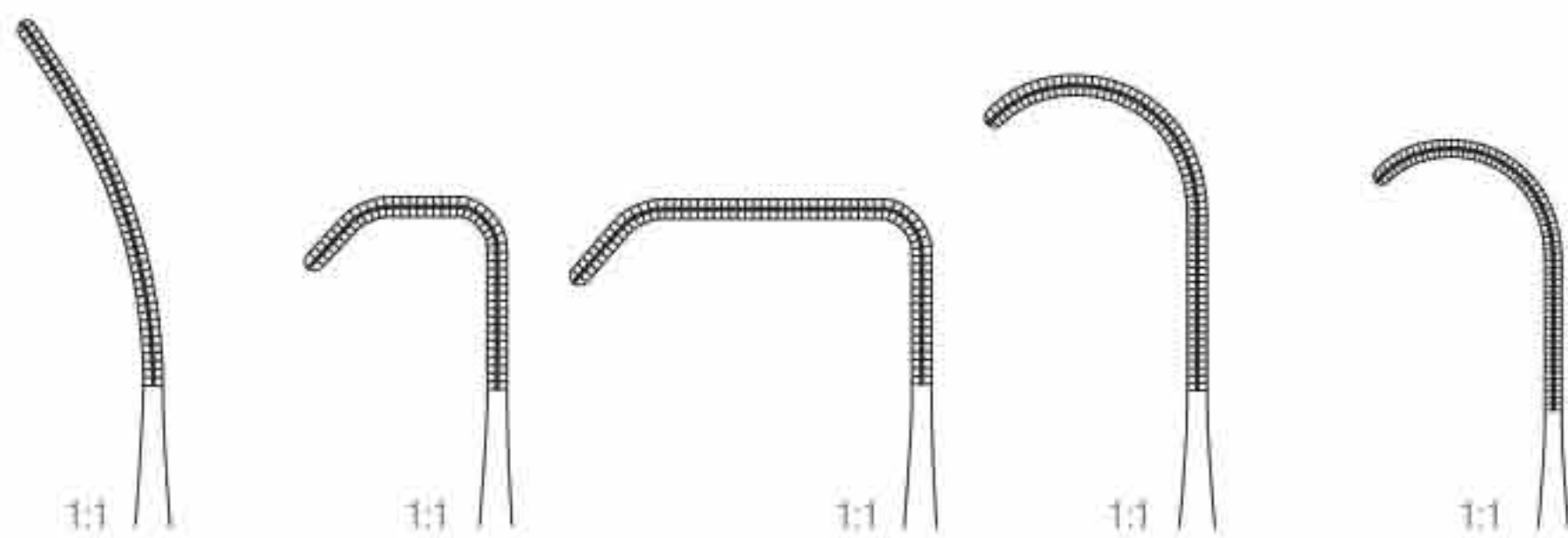

	atrauma	atrauma	atrauma	atrauma	atrauma
	Fig. 5	Fig. 6	Fig. 7	Fig. 8	Fig. 9
115 mm – 4 ½"	01-2071-01	01-2071-02	01-2071-03	01-2071-04	01-2071-05
145 mm – 5 ¾"	01-2072-01	01-2072-02	01-2072-03	01-2072-04	01-2072-05

Neonatal and children's clamps, extra delicate patterns

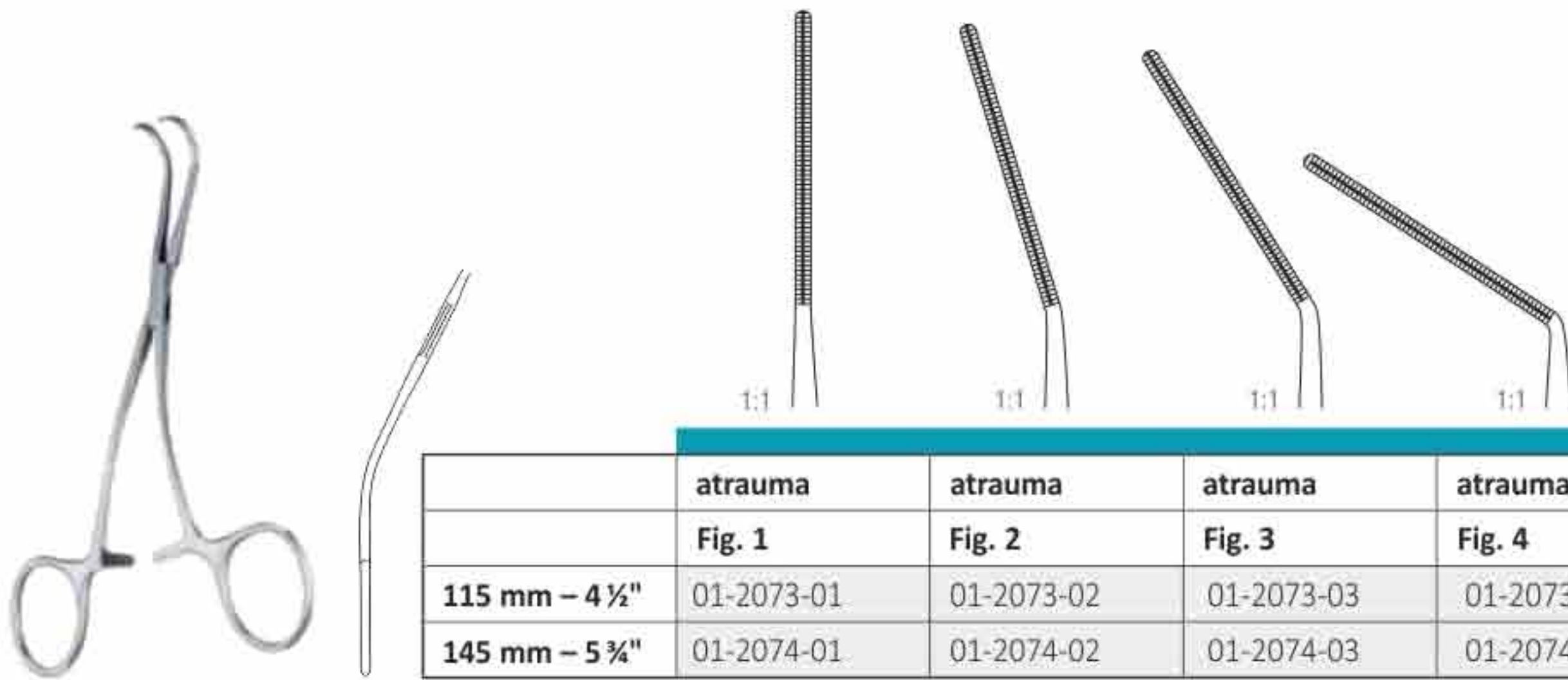

	atrauma	atrauma	atrauma	atrauma
	Fig. 1	Fig. 2	Fig. 3	Fig. 4
115 mm – 4 ½"	01-2073-01	01-2073-02	01-2073-03	01-2073-04
145 mm – 5 ¾"	01-2074-01	01-2074-02	01-2074-03	01-2074-04

angled on flat

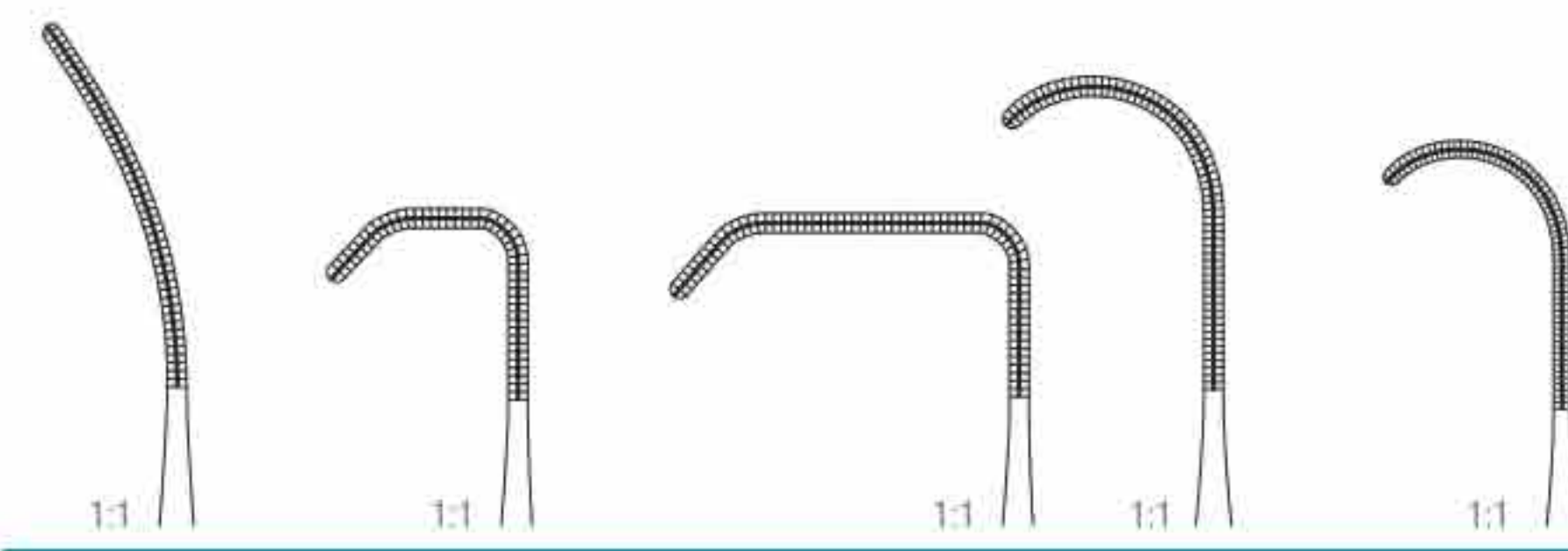

	atrauma	atrauma	atrauma	atrauma	atrauma
	Fig. 5	Fig. 6	Fig. 7	Fig. 8	Fig. 9
115 mm – 4 ½"	01-2075-01	01-2075-02	01-2075-03	01-2075-04	01-2075-05
145 mm – 5 ¾"	01-2076-01	01-2076-02	01-2076-03	01-2076-04	01-2076-05

Neonatal and children's clamps, extra delicate patterns

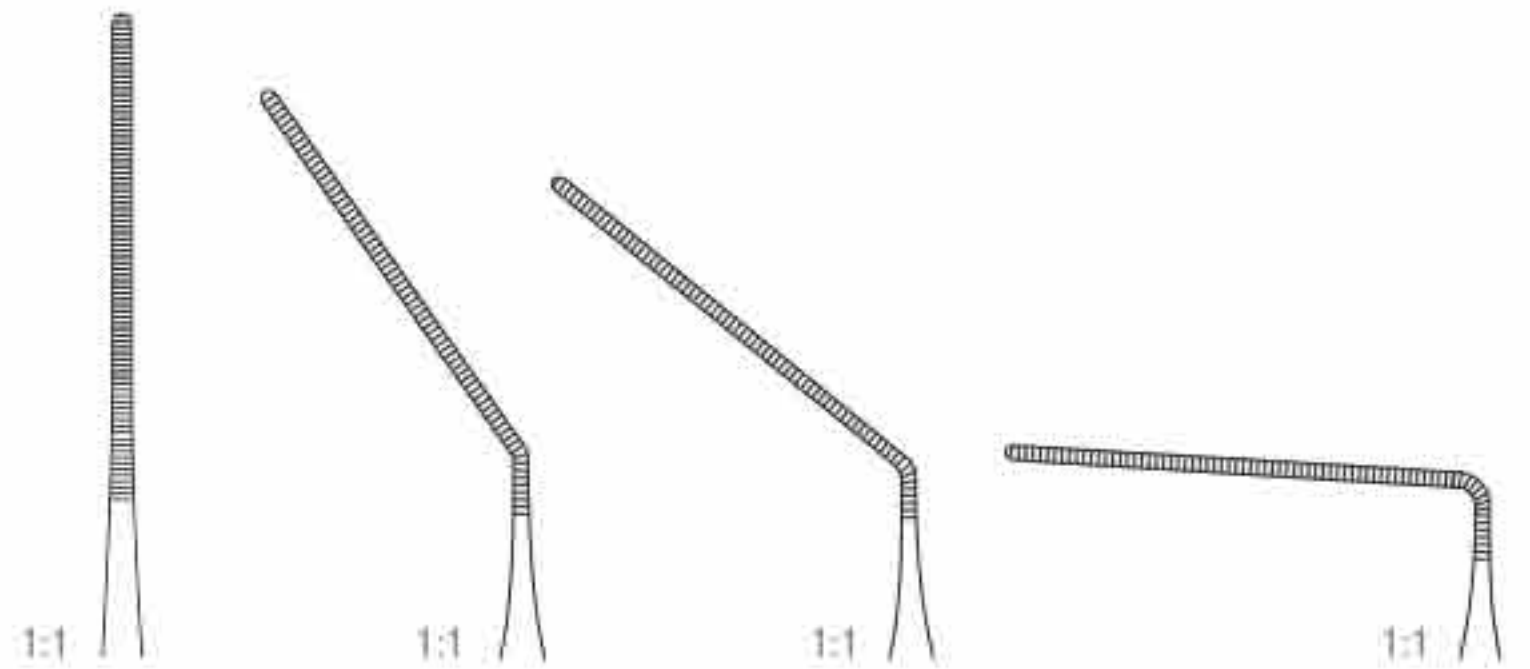

110 mm – 4 ¼ "				01-2077
130 mm – 5 "	01-2078-01	01-2078-02	01-2078-03	

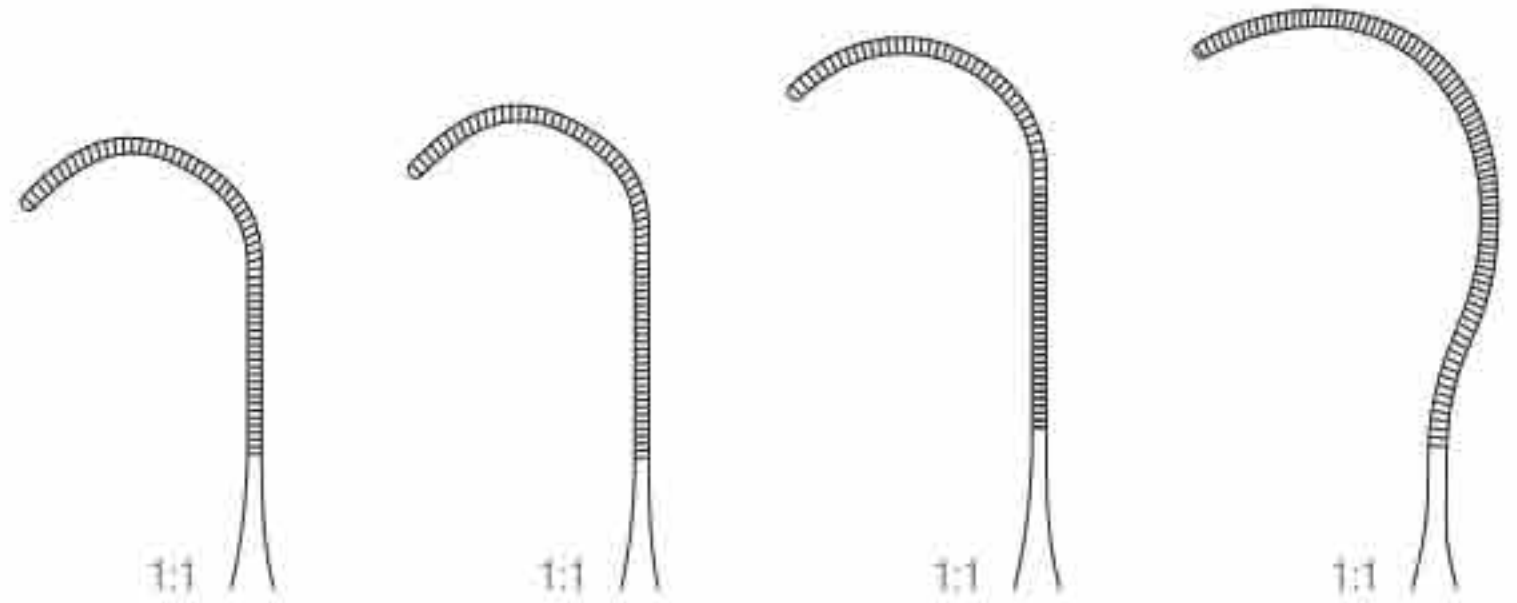

120 mm – 4 ¾ "	01-2079-01	01-2079-02	01-2079-03	01-2079-04
150 mm – 6 "	01-2080-01	01-2080-02	01-2080-03	01-2080-04

Vascular forceps



cooley

	atrauma	atrauma	atrauma
120 mm – 4 3/4 "	01-2081-01	01-2081-02	01-2081-03

straight curved S-curved



cooley

	atrauma	atrauma	atrauma
120 mm – 4 3/4 "	01-2082-01	01-2082-02	01-2082-03

sideways angled angled on flat 90° angled on flat



cooley

atrauma
170 mm – 6 3/4 "
01-2083

sideways angled

Vascular forceps

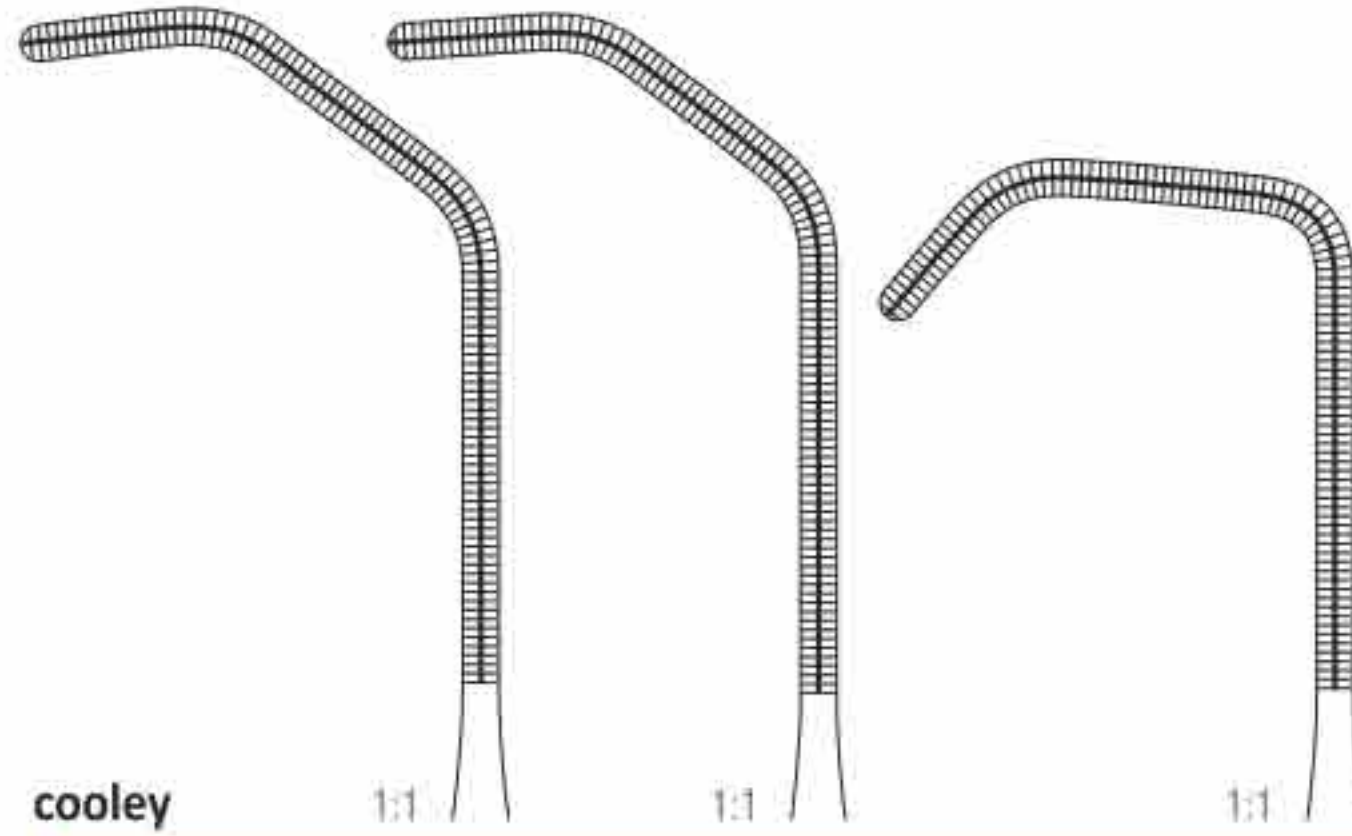

cooley

atrauma	atrauma	atrauma
175 mm – 7"	175 mm – 7"	165 mm – 6½"
01-2084	01-2085	01-2086

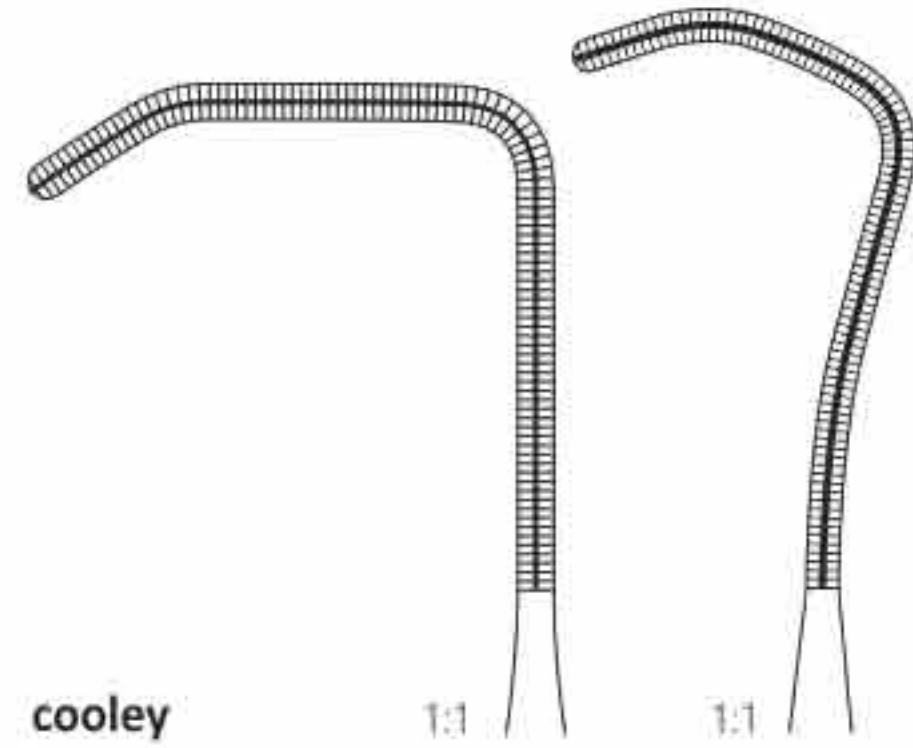

cooley

atrauma	atrauma
165 mm – 6½"	170 mm – 6¾"
01-2087	01-2088

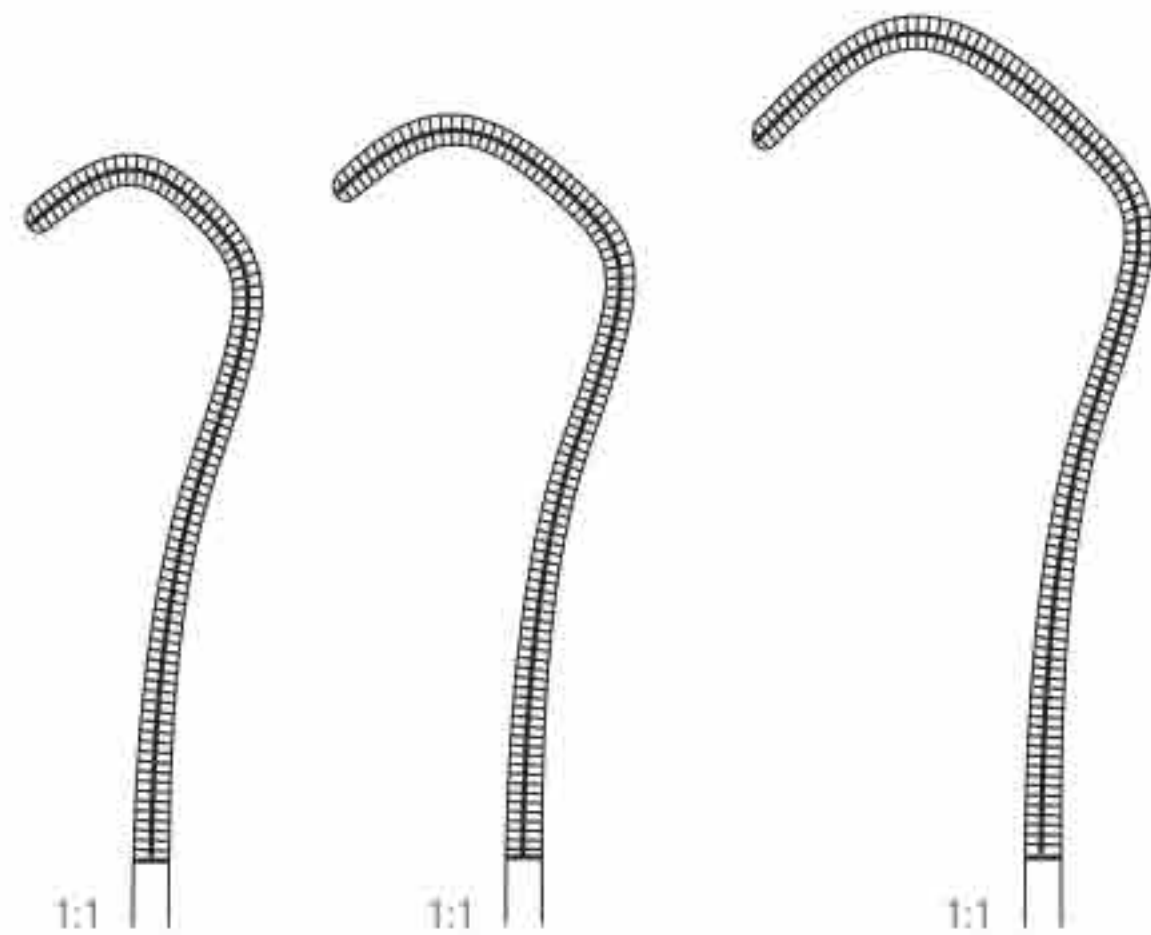

cooley-
DeRra

atrauma	atrauma	atrauma
165 mm – 6½"	170 mm – 6¾"	175 mm – 7"
01-2089-01	01-2089-02	01-2089-03

Vascular forceps



cooley-
Beck

1:1



1:1

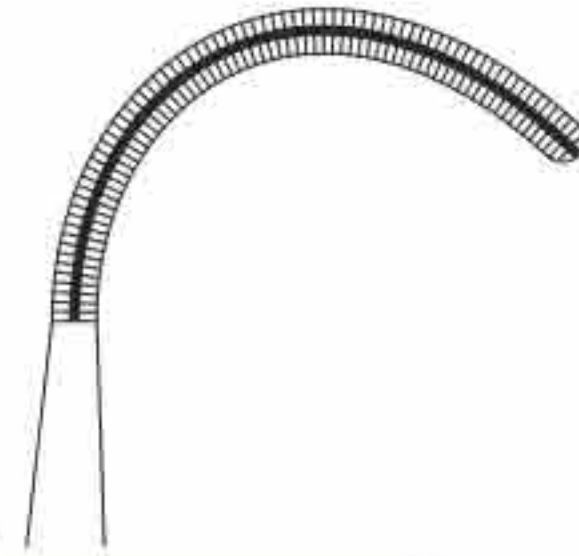

atrauma	
150 mm – 6"	155 mm – 6"
01-2090-01	01-2090-02



cooley

1:1

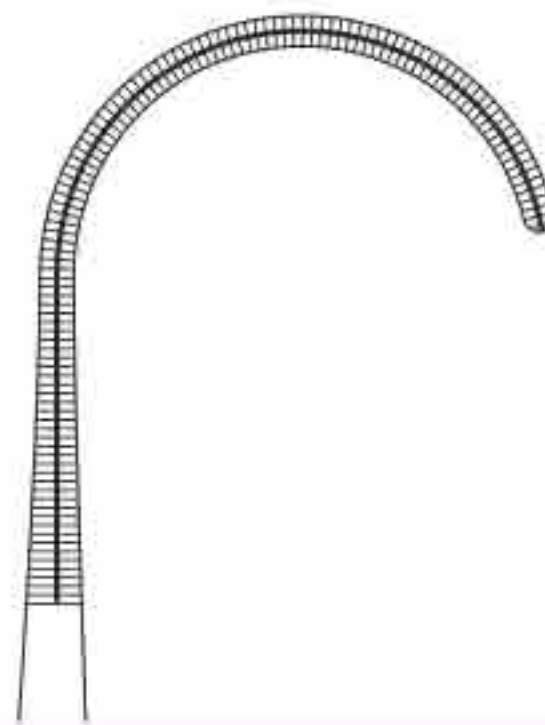

1:1

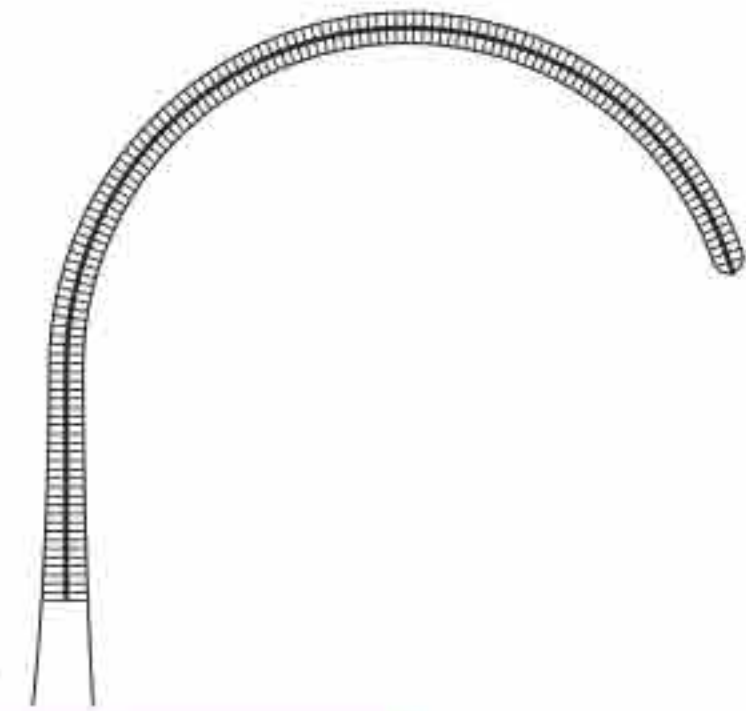

atrauma	
150 mm – 6"	160 mm – 6 ¼"
01-2091-01	01-2091-02

Vascular forceps

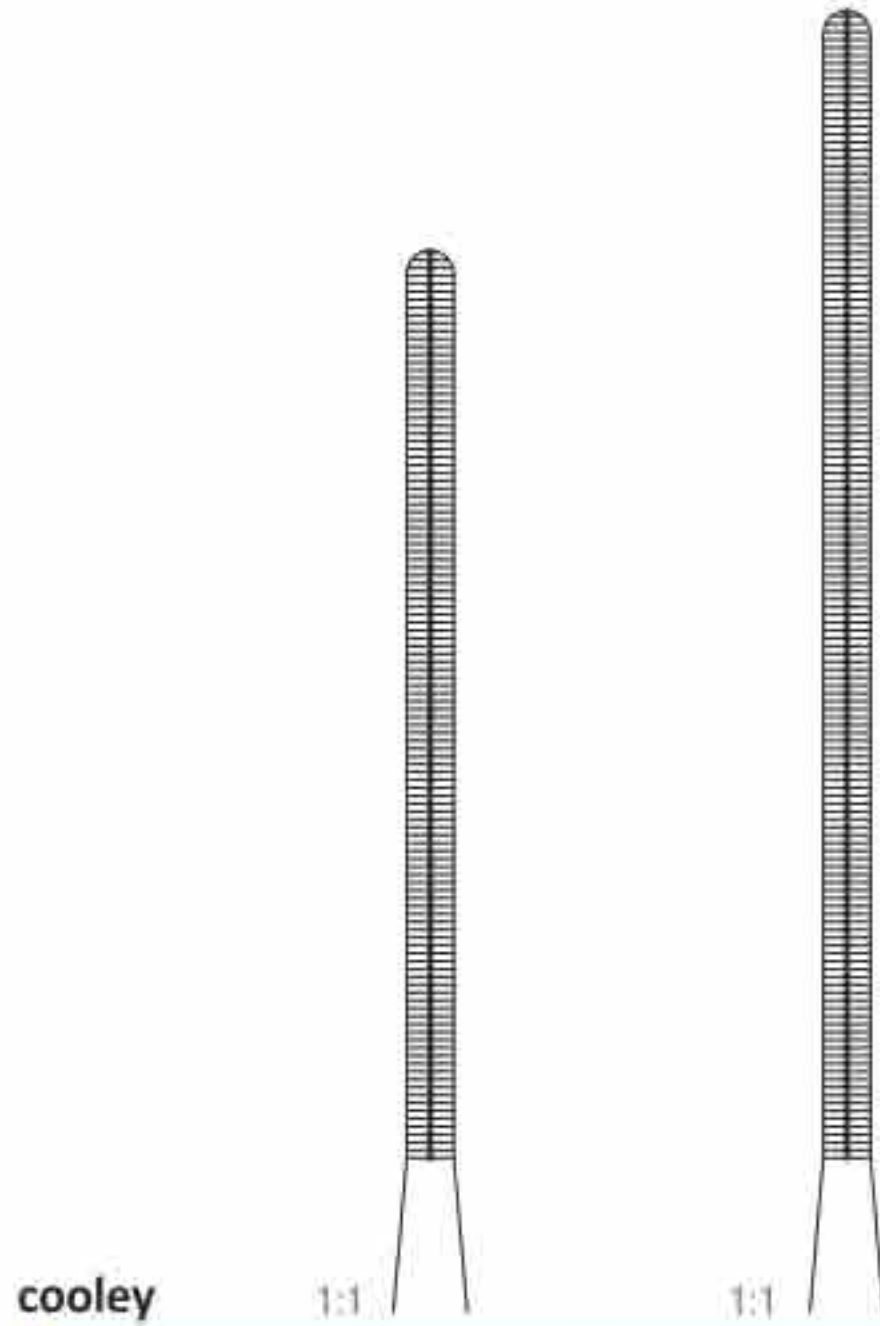

cooley

atrauma	atrauma
210 mm – 8 ¼ "	250 mm – 9 ¾ "
01-2092-01	01-2092-02

sidewards angled on flat sidewards angled on flat

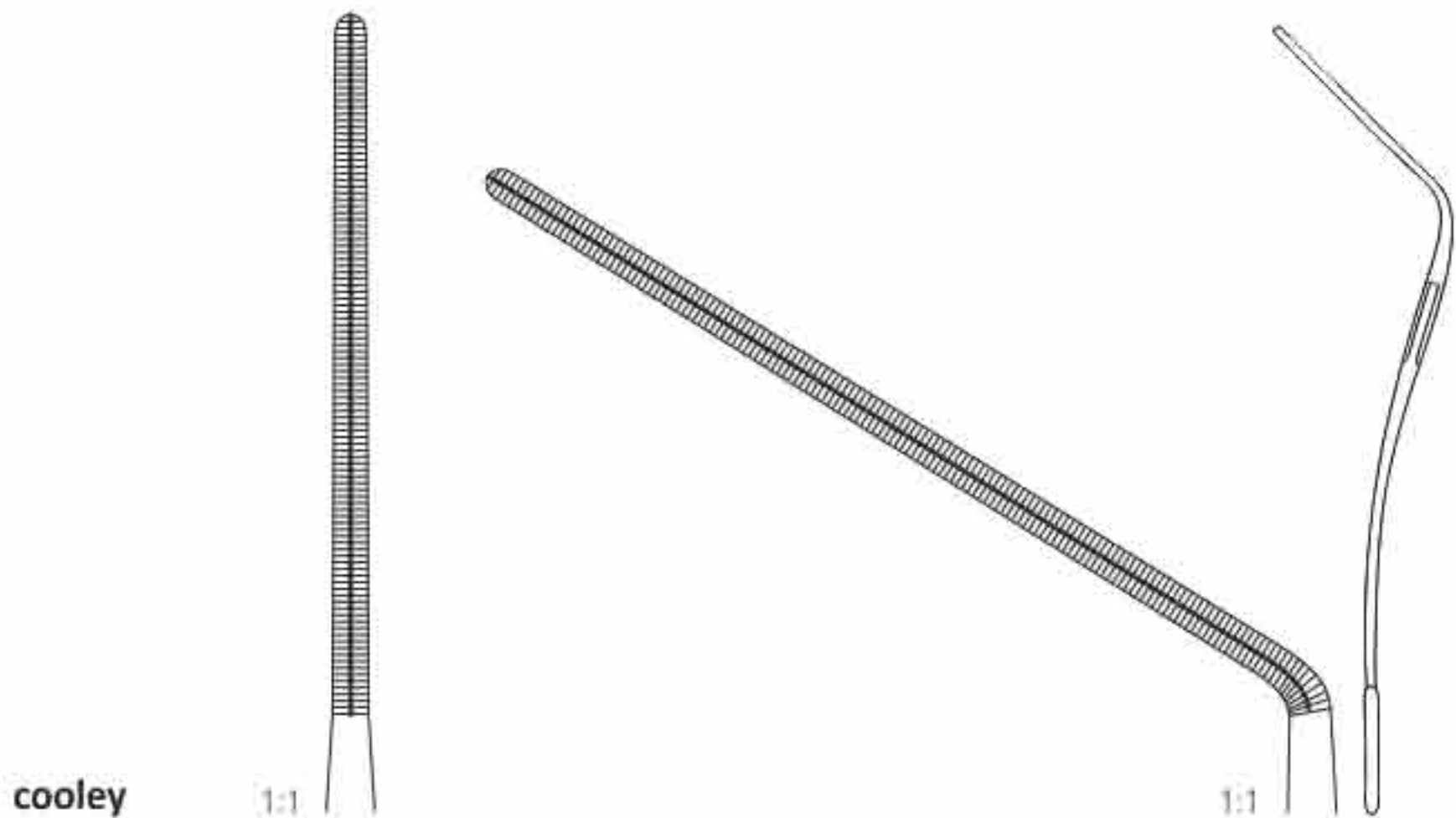

cooley

atrauma	atrauma
180 mm – 7 "	185 mm – 7 ¼ "
01-2093-01	01-2093-02

straight

angled on flat

Vascular forceps

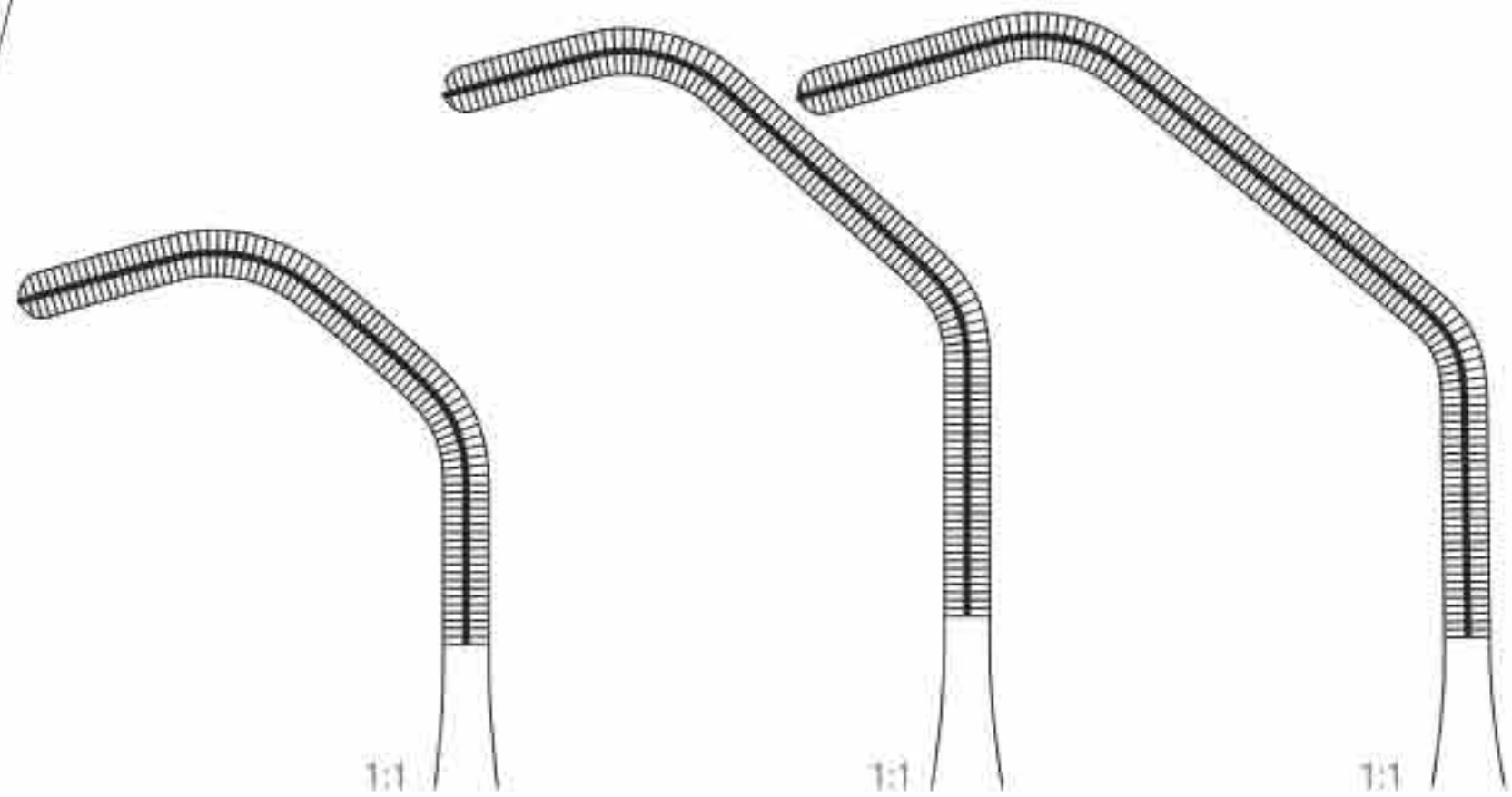

cooley-tanGential

atrauma	atrauma	atrauma
195 mm – 7 ¾ "	255 mm – 10	260 mm – 10 ¼ "
01-2094-01	01-2094-02	01-2094-03

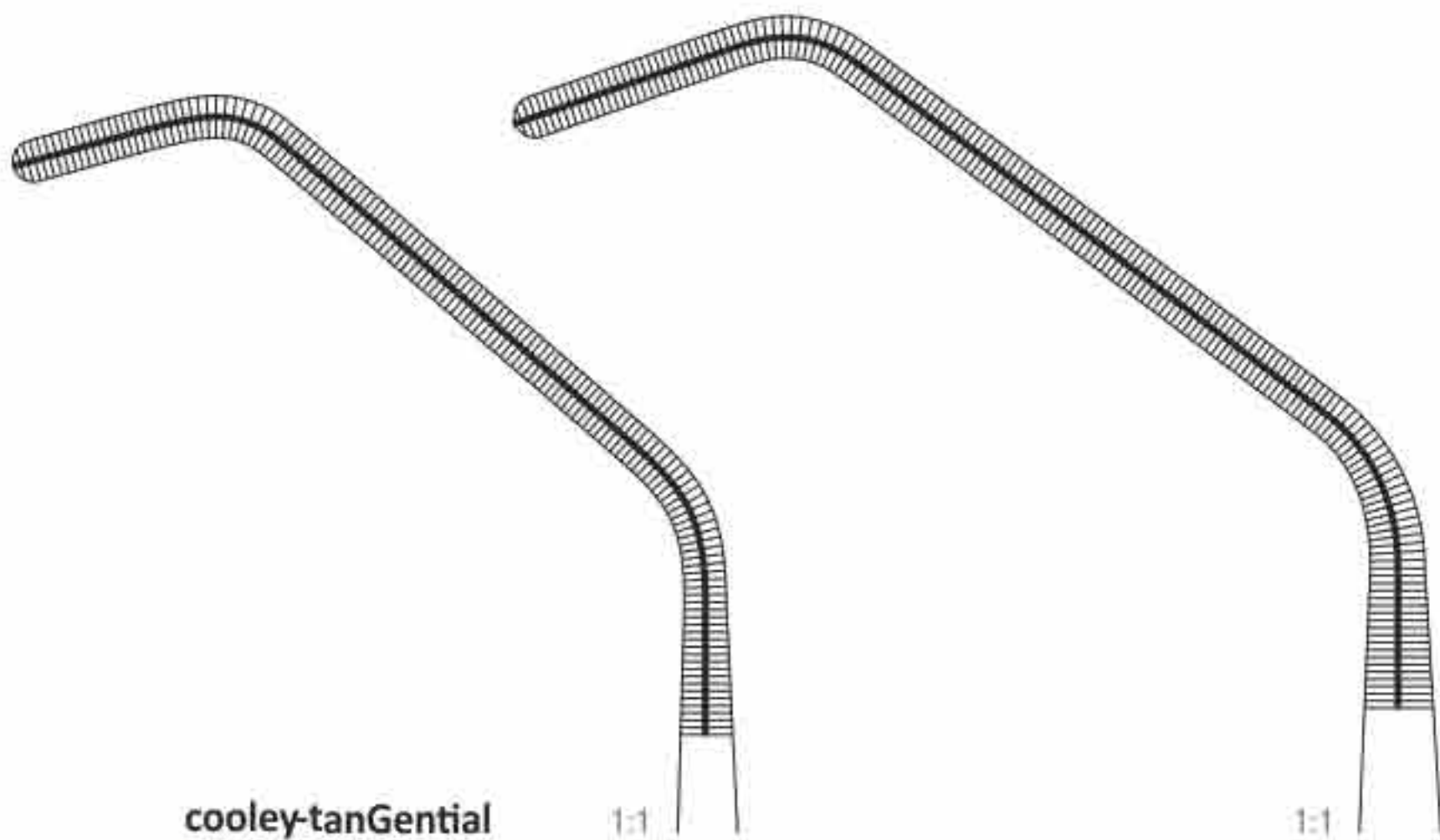

cooley-tanGential

atrauma	atrauma
265 mm – 10 ½ "	270 mm – 10 ¾ "
01-2095-01	01-2095-02

Multi-purpose clamps, pediatric, graduated

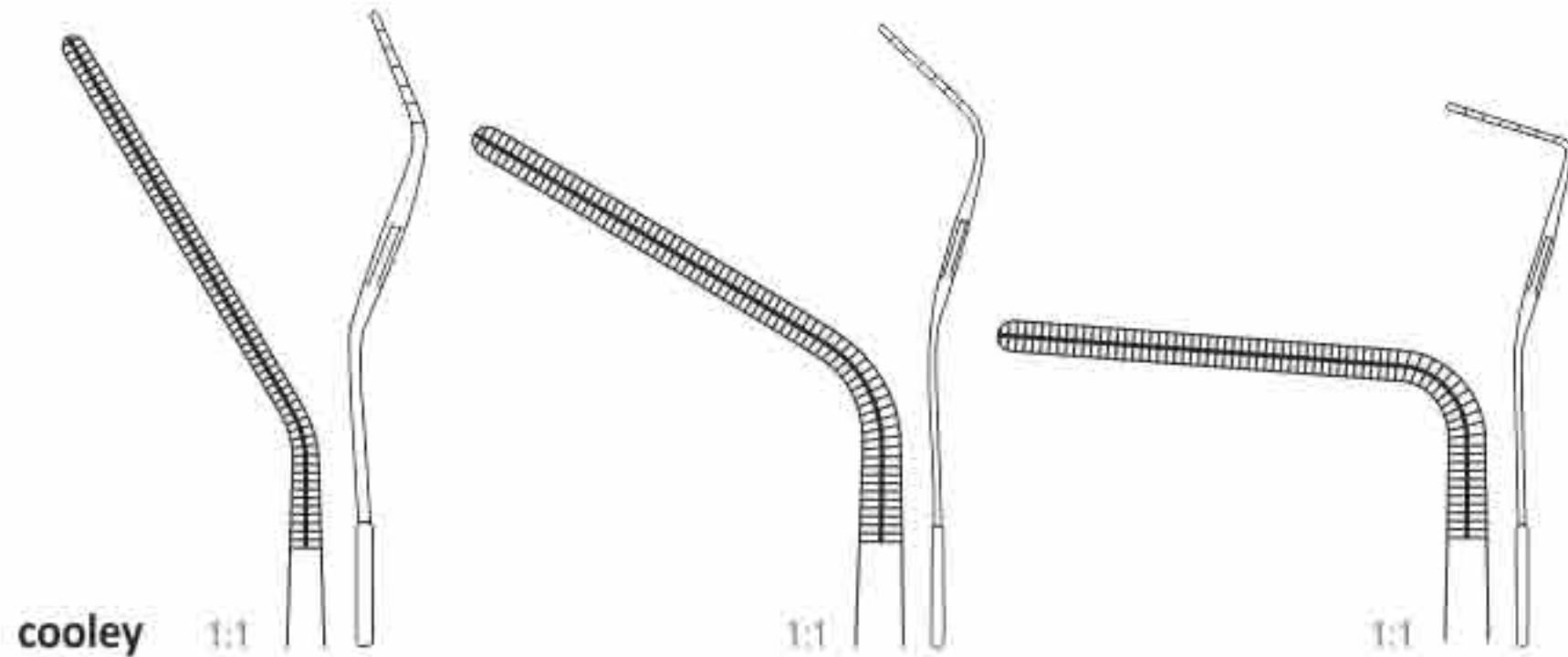

cooley		
atrauma	atrauma	atrauma
25°	45°	90°
165 mm – 6 ½ "	160 mm – 6 ¼ "	145 mm – 5 ¾ "
01-2096-01	01-2096-02	01-2096-03

cooley
patent Ductus clamp



160 mm – 6 ¼ "	01-2097-01	01-2098-01
170 mm – 6 ¾ "	01-2097-02	01-2098-02
200 mm – 8 "	01-2097-03	01-2098-03
230 mm – 9 "	01-2097-04	01-2098-04
250 mm – 10 "		01-2098-05

angled on flat, graduated

Multi-purpose clamps, pediatric, graduated

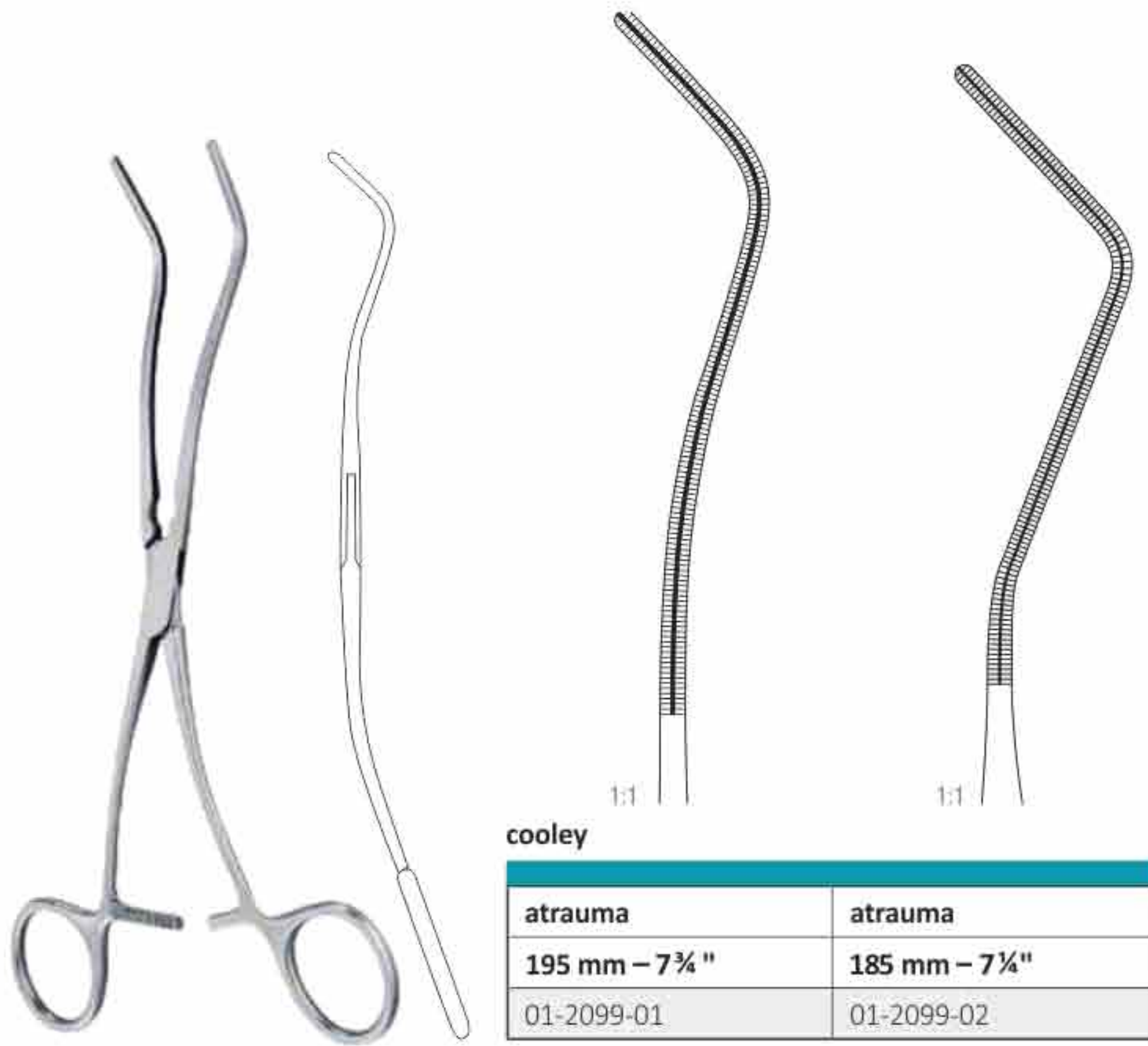

cooley

cooley	
atrauma	atrauma
195 mm – 7¾"	185 mm – 7¼"
01-2099-01	01-2099-02

Multi-purpose clamps



cooley

atrauma
315 mm – 12 ½"
01-2102

S-curved

cooley

atrauma	atrauma
265 mm – 10 ½"	335 mm – 13 ¼"
01-2100-01	01-2101-02

Polypus and dressing forceps



Gross-Maier

200 mm – 8"	01-2110-01	01-2111-01
220 mm – 8 ¾"	01-2110-02	01-2111-02
250 mm – 9 ¾"	01-2110-03	01-2111-03
270 mm – 10 ¾"	01-2110-04	01-2111-04

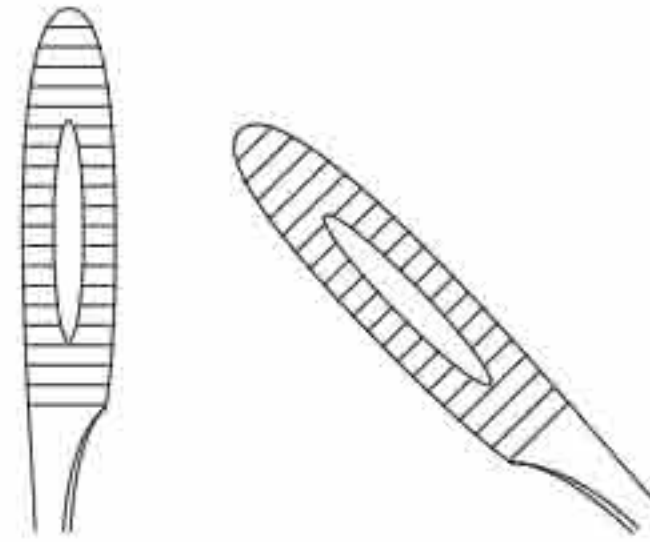

Maier

200 mm – 8"	01-2112-01	01-2113-01
250 mm – 9 ¾"	01-2112-02	01-2113-02

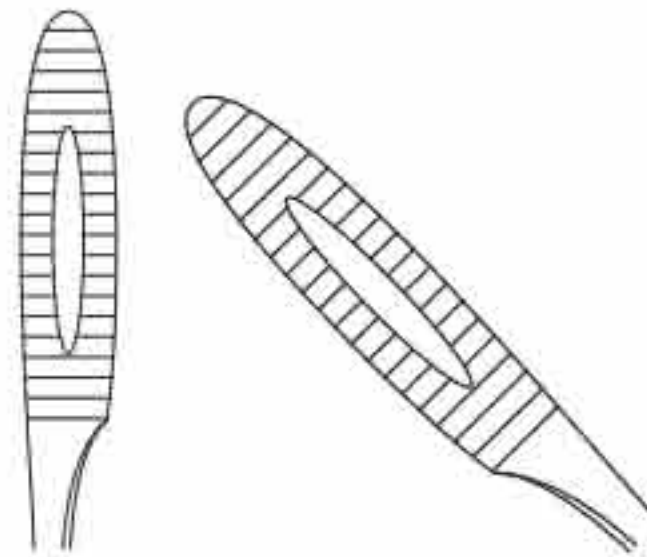

Ulrich

220 mm – 8 ¾"	01-2114-01	01-2115-01
250 mm – 9 ¾"	01-2114-02	01-2115-02
270 mm – 10 ¾"	01-2114-03	01-2115-03

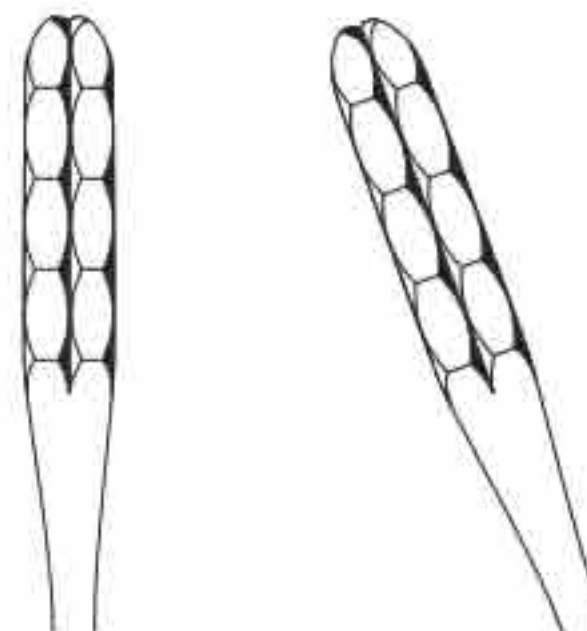

Sponge holding forceps



raMpley

180 mm – 7"	01-2116-01	
250 mm – 9 ¾"	01-2116-02	01-2117

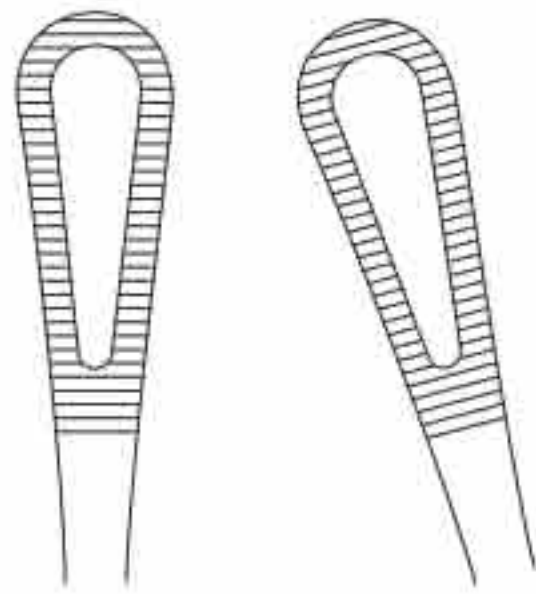

collin

250 mm – 9 ¾"
01-2118



1:2

Sponge holding forceps

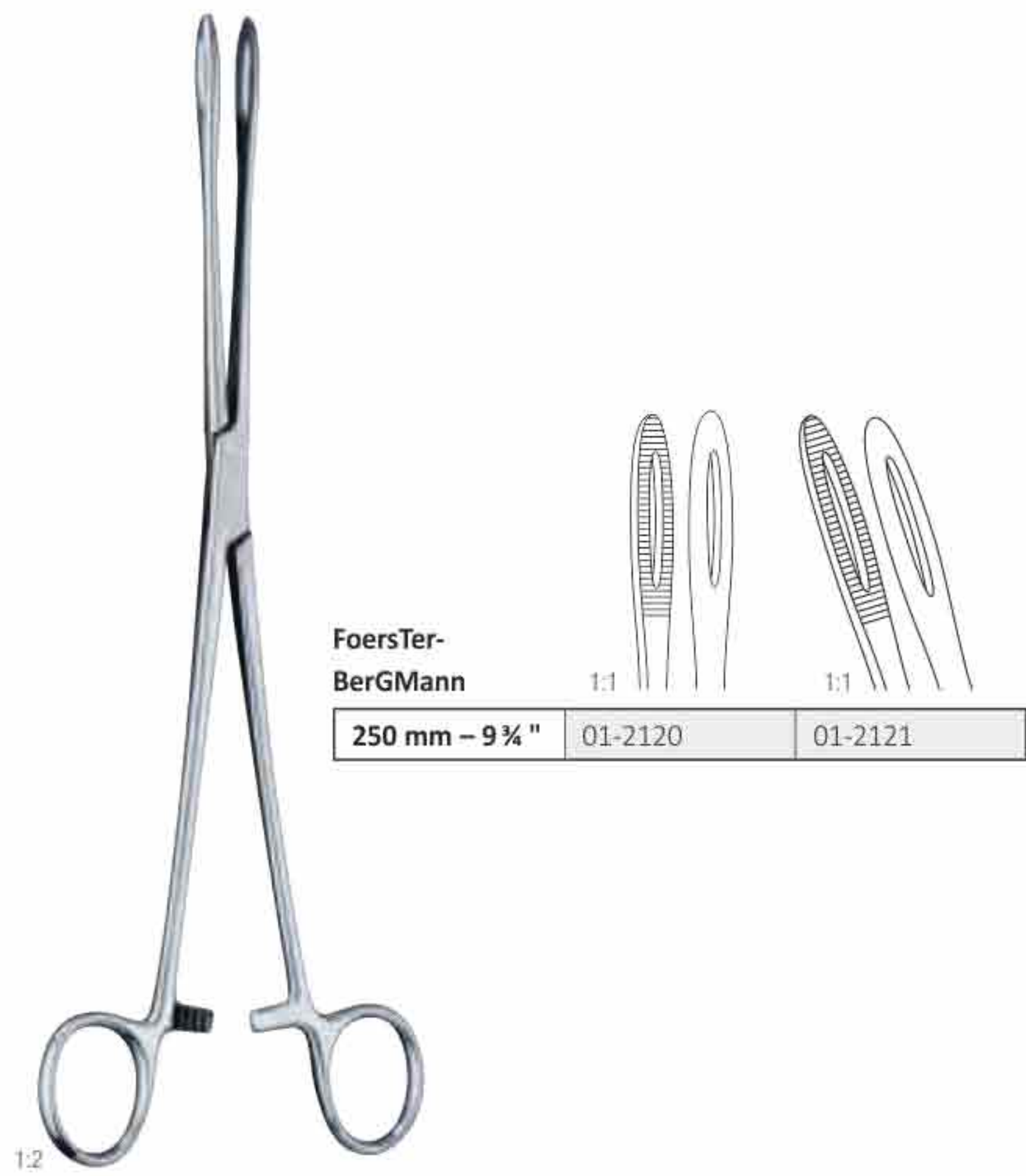
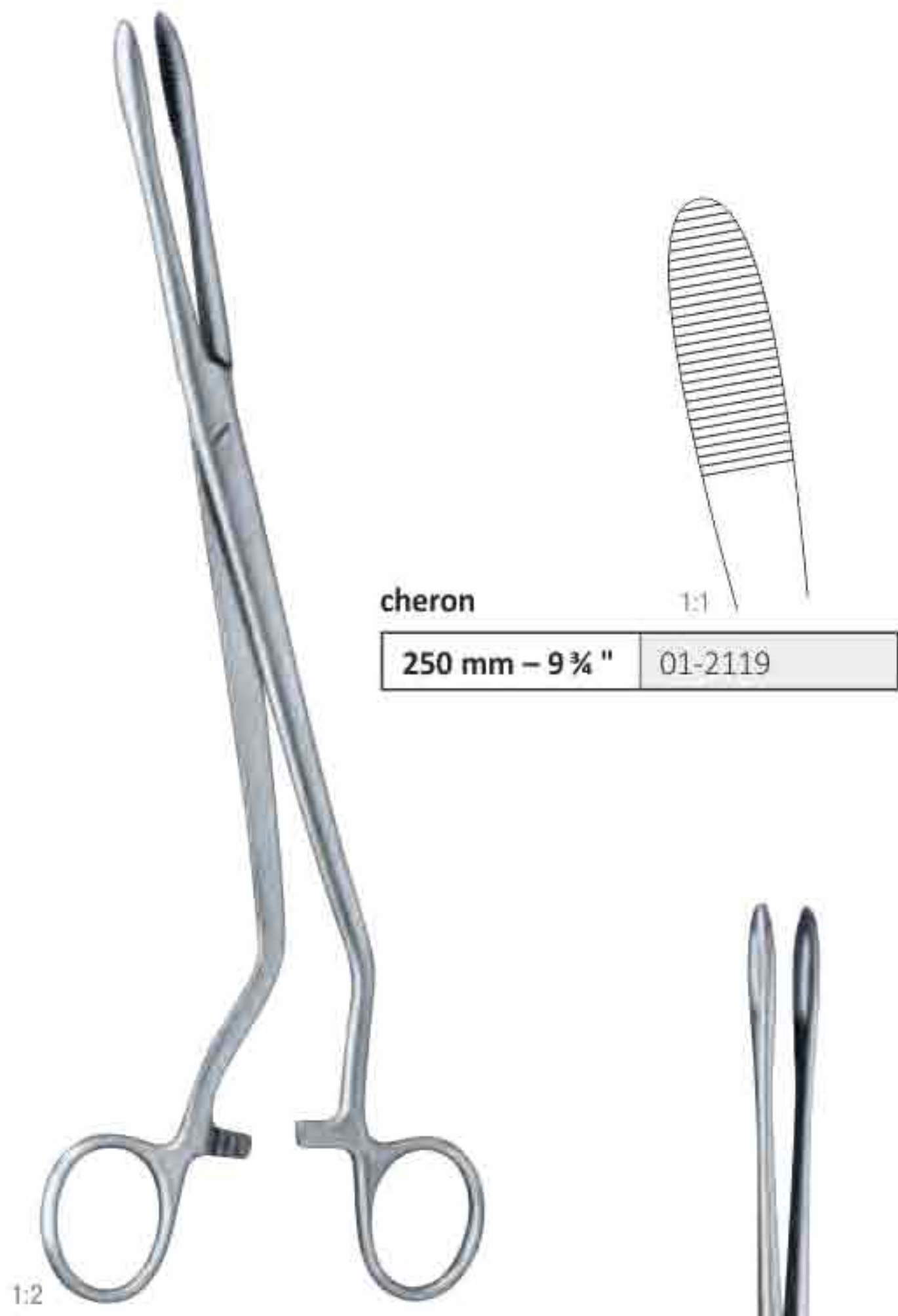

Sponge holding forceps

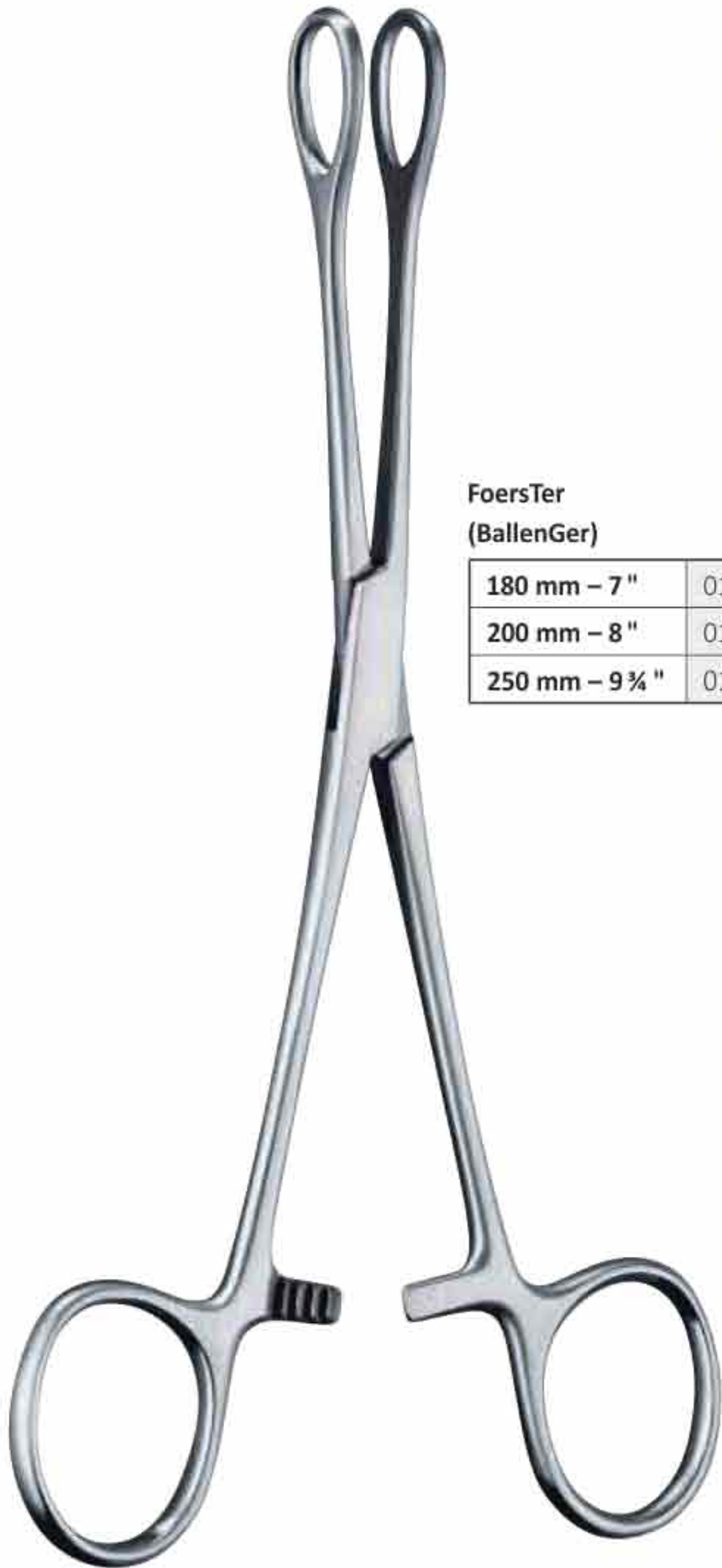

**Foerster
(Ballenger)**

180 mm – 7"	01-2122-01	01-2123-01	01-2124-01	01-2125-01
200 mm – 8"	01-2122-02	01-2123-02	01-2124-02	01-2125-02
250 mm – 9 ¼"	01-2122-03	01-2123-03	01-2124-03	01-2125-03

Sponge holding forceps



BozeMann 1:1
260 mm – 10 ¼"
01-2126
S-curved



BozeMann-
DoUGlas 1:1
260 mm – 10 ¼"
01-2127
S-curved

Polypus and dressing forceps – Sponge holding forceps



pelKMan

250 mm – 9 3/4 "	01-2128-01	01-2128-02
------------------	------------	------------

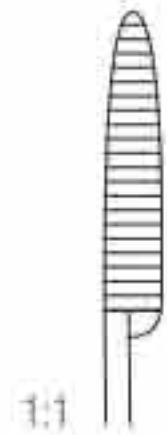

1:1



1:1

curved



MarTin

170 mm – 6 3/4 "	01-2129-01	01-2130-01
255 mm – 10 "	01-2129-02	01-2130-02



Polypus and dressing forceps – Sponge holding forceps



Sinus forceps

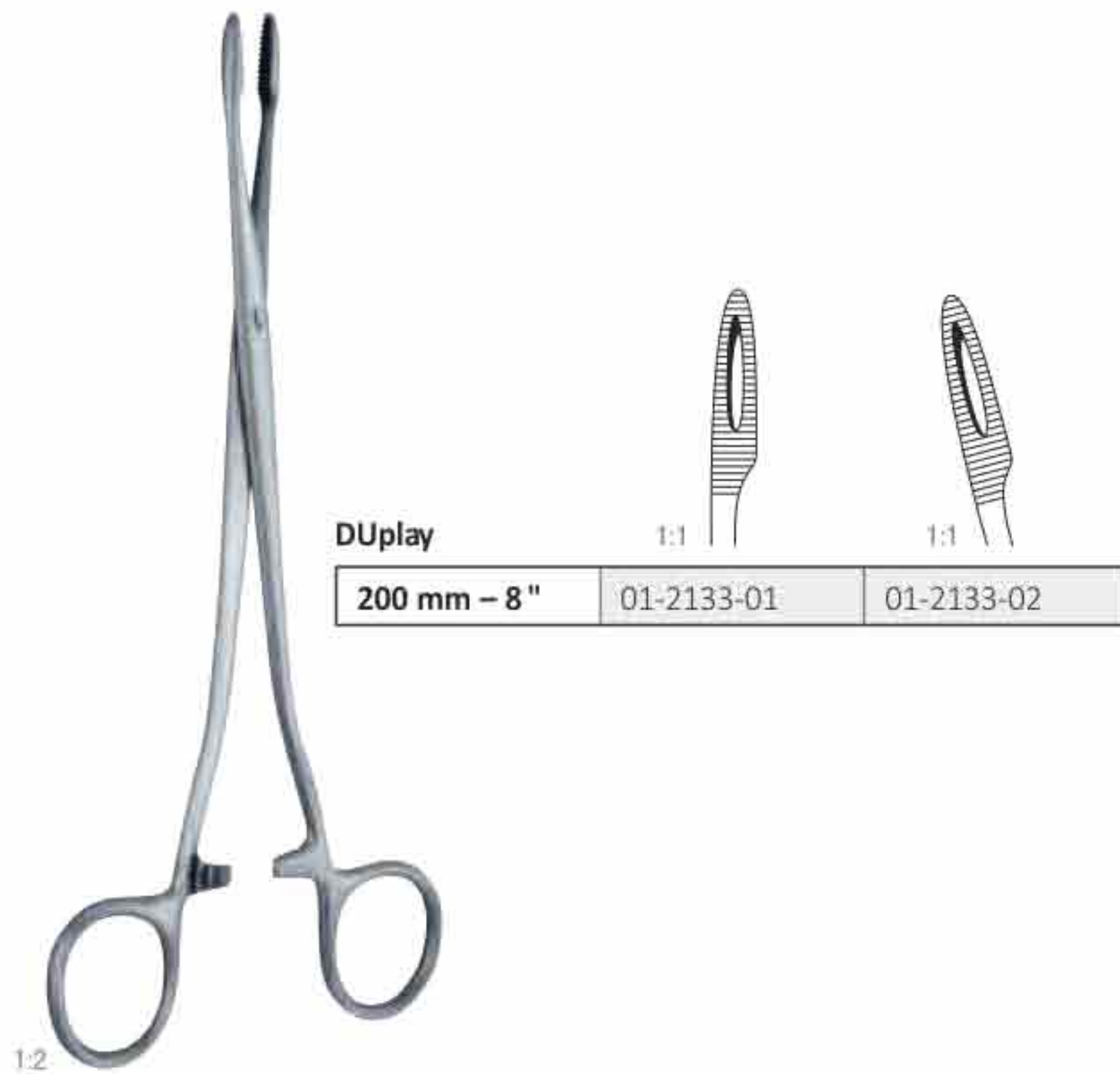

Needle holders.



Crile-Murray

		T.C
150 mm – 6 "	01-2140-01	01-2141-01
180 mm – 7 "	01-2140-02	01-2141-02
200 mm – 8 "	01-2140-03	01-2141-03



BauMGartNER

		T.C
120 mm – 4 ¾ "	01-2142-01	01-2142-01
140 mm – 5 ¾ "	01-2142-02	01-2142-02



Needle holders



Crile-Wood



BaBy-Crile-Wood

		T.C	T.C
150 mm – 6"	01-2143-01	01-2144-01	01-2145-01
180 mm – 7"	01-2143-02	01-2144-02	01-2145-02
200 mm – 8"	01-2143-03	01-2144-03	01-2145-03
230 mm – 9"		01-2144-04	01-2145-04
260 mm – 10 ¼"		01-2144-05	01-2145-05
300 mm – 12"		01-2144-06	01-2145-06

	T.C
150 mm – 6"	01-2146

smooth

Needle holders.



BROWN

130 mm – 5"	01-2147-01
180 mm – 7"	01-2147-02

heavy pattern, diagonally serrated jaw



COLLIER

125 mm – 5"	01-2148
-------------	---------



1:2
DERF



1:2



1:2
DERF (WRIGHT)

		T.C
125 mm – 5"	120 mm – 4 ¾"	120 mm – 4 ¾"
01-2149	01-2150	01-2151

Needle holders



WEBSTER

		T.C	T.C
130 mm – 5"	01-2152	01-2153	01-2154

smooth

smooth

serrated

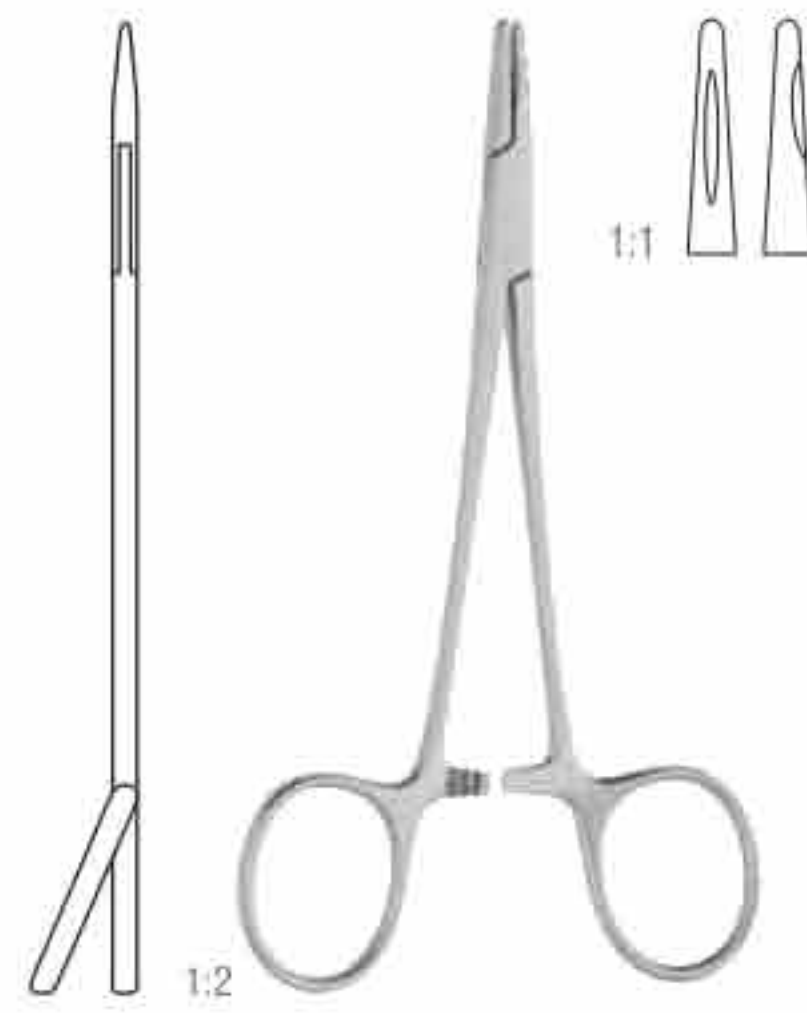

NEIVERT

125 mm – 5"	01-2155
--------------------	---------

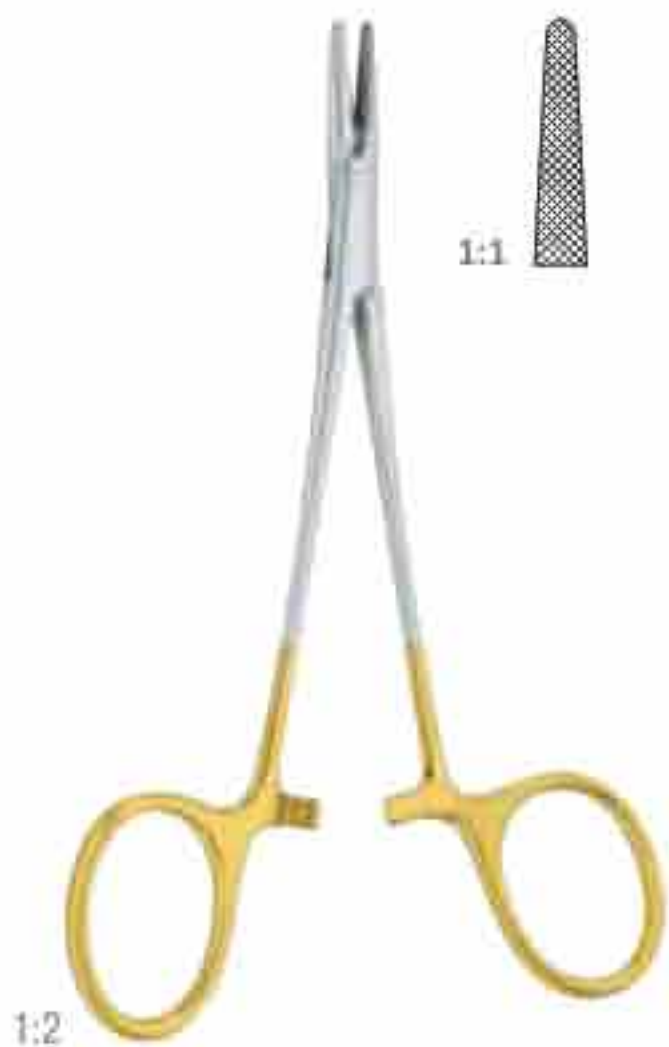

NEIVERT (MASING)

	T.C
130 mm – 5"	01-2156

one ring angled

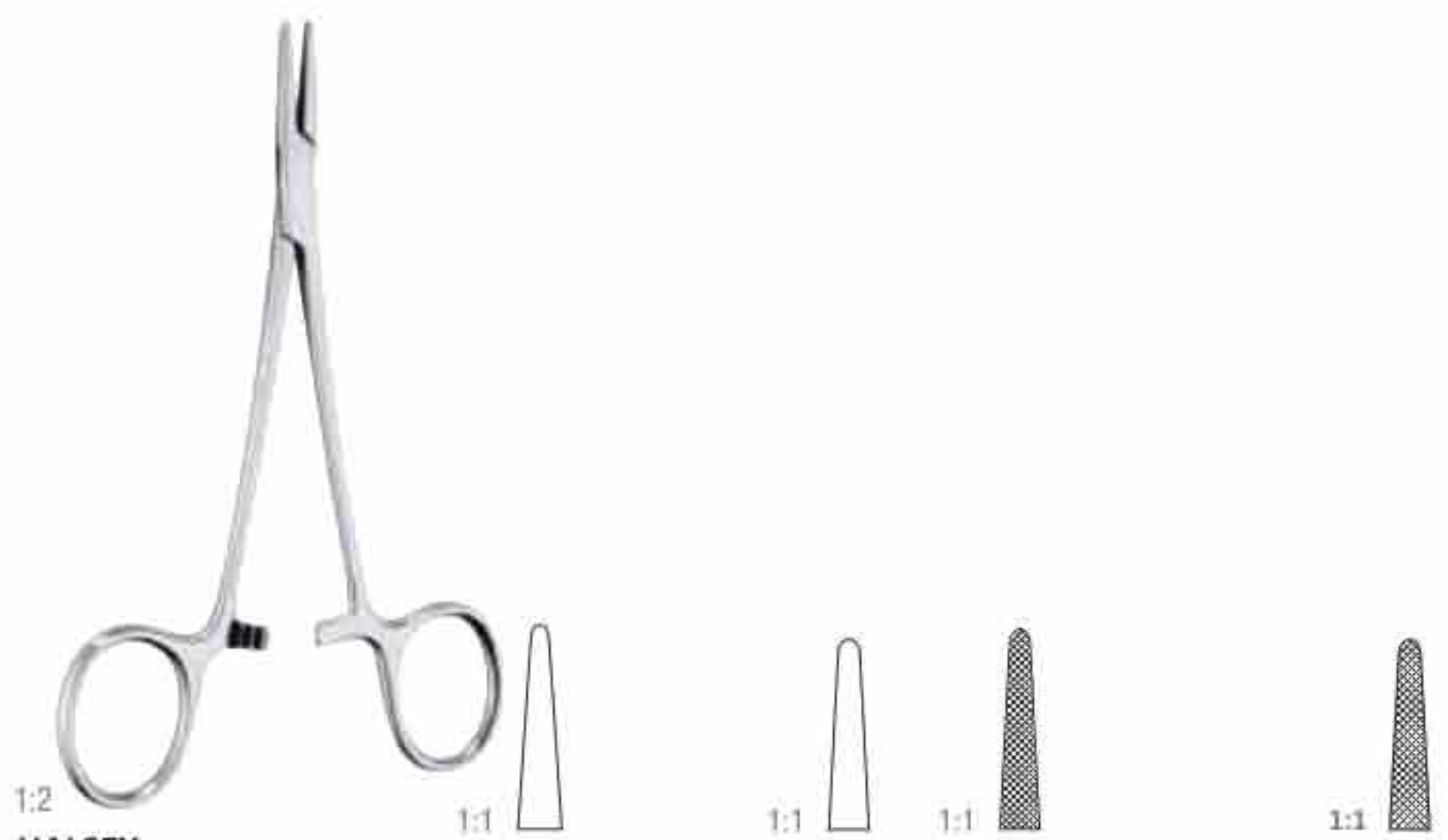

HALSEY

		T.C		T.C
130 mm – 5"	01-2157	01-2158	01-2159	01-2160

smooth

smooth

serrated

serrated

Needle holders



Mayo-HEGar

140 mm – 5 ½ "	160 mm – 6 ¼ "	180 mm – 7 "	200 mm – 8 "	240 mm – 9 ½ "	260 mm – 10 ¼ "	300 mm – 12 "
01-2161-01	01-2161-02	01-2161-03	01-2161-04	01-2161-05	01-2161-06	01-2161-07

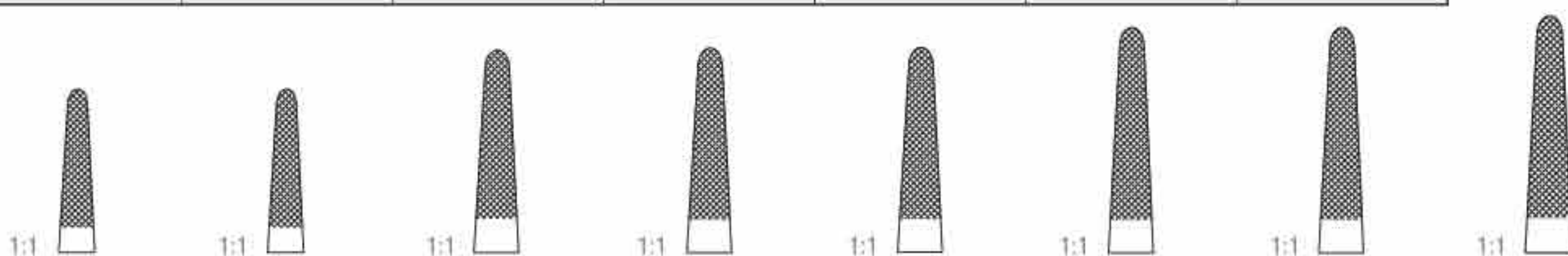

Mayo-HEGar

T.C	T.C	T.C	T.C	T.C	T.C	T.C	T.C
140 mm – 5 ½ "	160 mm – 6 ¼ "	180 mm – 7 "	200 mm – 8 "	240 mm – 9 ½ "	260 mm – 10 ¼ "	300 mm – 12 "	340 mm – 13 ½ "
01-2162-01	01-2162-02	01-2162-03	01-2162-04	01-2162-05	01-2162-06	01-2162-07	01-2162-08

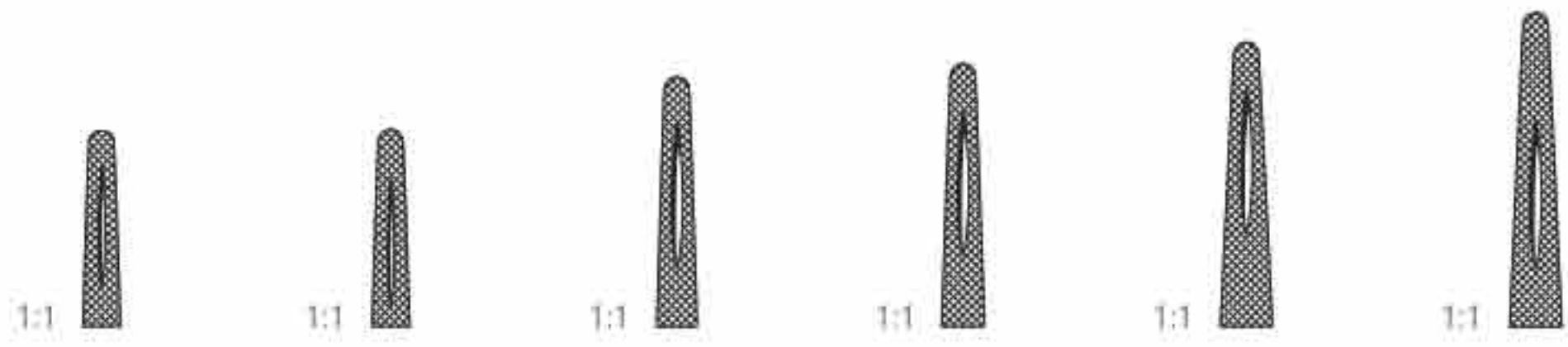

Mayo-HEGar

140 mm – 5 ½ "	160 mm – 6 ¼ "	180 mm – 7 "	200 mm – 8 "	240 mm – 9 ½ "	260 mm – 10 ¼ "
01-2163-01	01-2163-02	01-2163-03	01-2163-04	01-2163-05	01-2163-06

delicate pattern

Mayo-HEGar

T.C	T.C	T.C	T.C	T.C	T.C
140 mm – 5 ½ "	160 mm – 6 ¼ "	180 mm – 7 "	200 mm – 8 "	240 mm – 9 ½ "	260 mm – 10 ¼ "
01-2164-01	01-2164-02	01-2164-03	01-2164-04	01-2164-05	01-2164-06

delicate pattern

Mayo-HEGar

T.C	T.C
240 mm – 9 ½ "	260 mm – 10 ¼ "
01-2165-01	01-2165-02

curved



Needle holders.



HEGAR

		T.C
150 mm – 6 "	01-2166-01	01-2167-01
175 mm – 7 "	01-2166-02	01-2167-02
205 mm – 8 "	01-2166-03	01-2167-03
240 mm – 9 ½ "		01-2167-04

heavy pattern

Needle holders



HEaNEy

		T.C
160 mm – 6 ¼ "	01-2168-01	01-2169-01
180 mm – 7 "	01-2168-02	01-2168-02
200 mm – 8 "	01-2168-03	01-2168-03

Needle holders



sarot

		T.C
180 mm – 7"	01-2169-01	01-2170-01
200 mm – 8"		01-2170-02
260 mm – 10 ¼"	01-2169-02	01-2170-03

JaMEsoN

1:2

		T.C
235 mm – 9 ¼"	01-2171	01-2172

Needle holders



1:2

MassoN

		T.C
270 mm – 10 ¾ "	01-2173	01-2174

1:2

FiNoCHiEtto

		T.C
200 mm – 8 "	01-2175-01	01-2176-01
270 mm – 10 ¾ "	01-2175-02	01-2176-02

Needle holders.

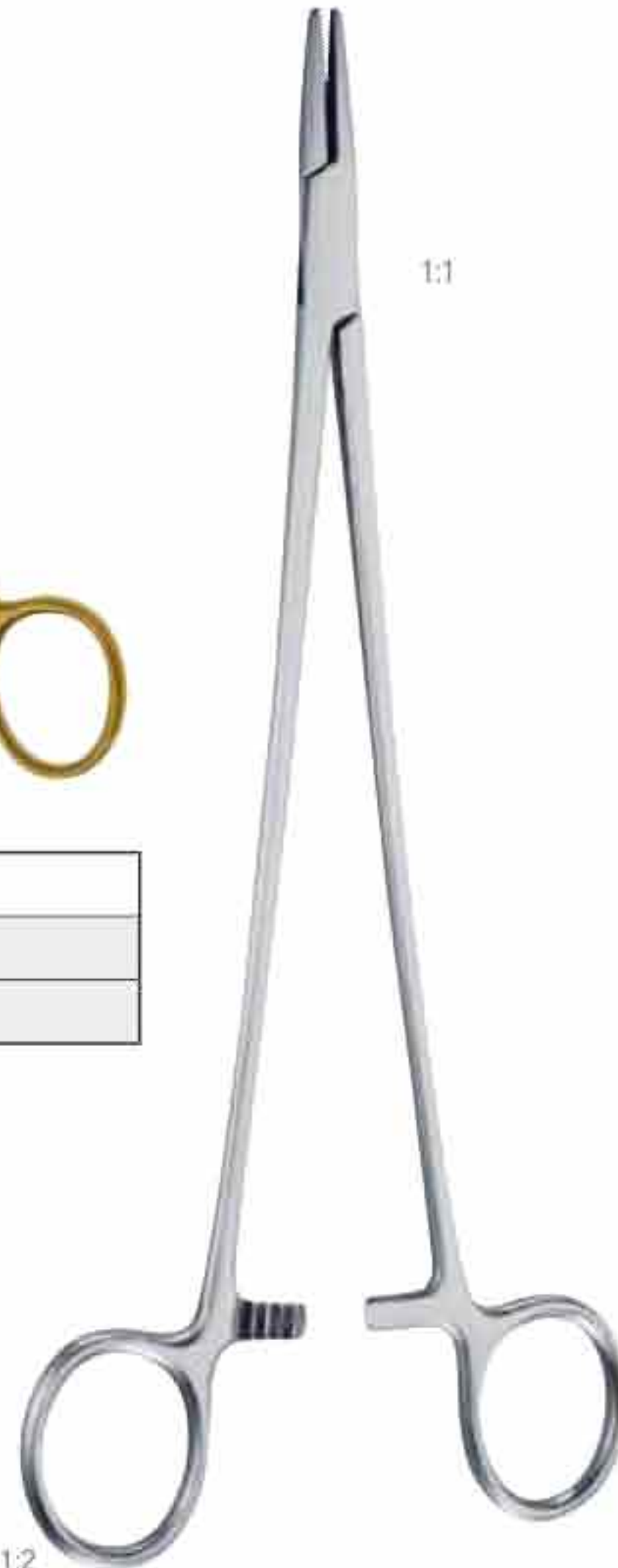

strattE

		T.C
210 mm – 8 ¼"		01-2178-01
230 mm – 9"	01-2177	01-2178-02

1:2
WaNGENstEEN

		T.C
270 mm – 10 ¾"	01-2179	01-2180

Needle holders



BOZEMANN (WERTHEIM)

		T.C
200 mm – 8"	01-2181-01	01-2182-01
240 mm – 9 1/2"	01-2181-02	01-2182-02
260 mm – 10 1/4"		01-2182-03
300 mm – 12"		01-2182-04



1:2
**THOMSON-WALKER
(BOZEMANN)**

200 mm – 8"	01-2183
-------------	---------

Needle holders

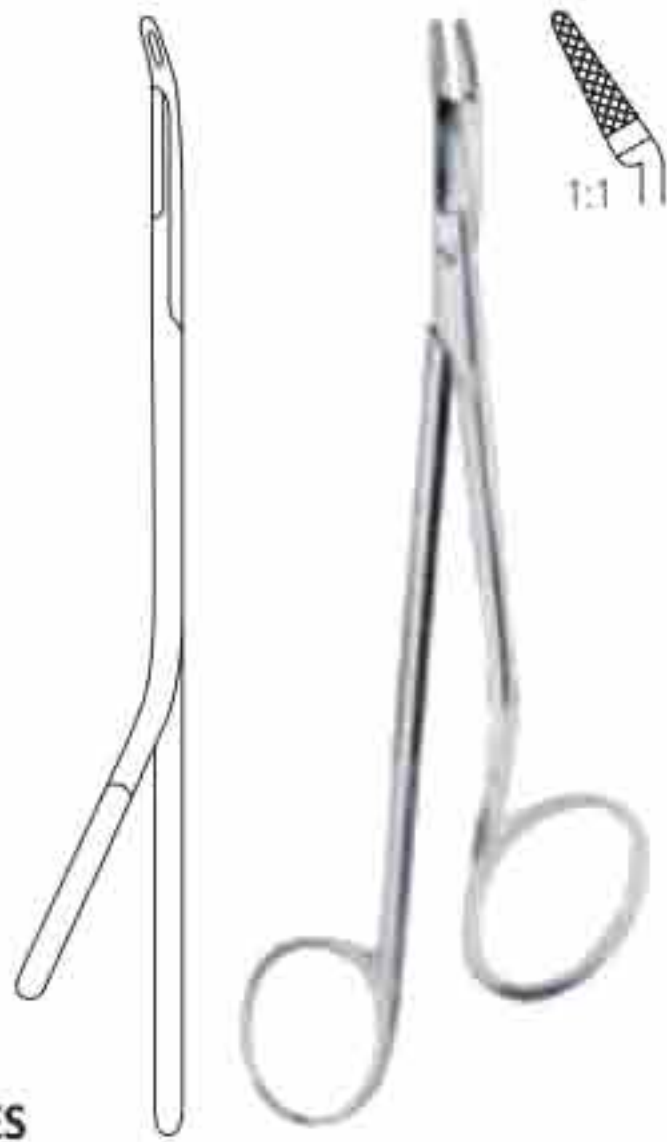

GILLIES

145 mm – 5 ¾ "	01-2183
----------------	---------







GILLIES

		T.C
130 mm – 5 "		01-2185-01
160 mm – 6 ¼ "	01-2184	01-2185-02



1:2

FOSTER-GILLIES

	 1:2	 1:2	 1:2	 1:2
	T.C	T.C	T.C	T.C
120 mm – 4 ¾ "	01-2186	01-2187	01-2188	01-2189

straight, serrated

straight, smooth

curved, serrated

curved, smooth

Needle holders.



OLSEN-HEGAR

		T.C
115 mm – 4 ½"	01-2190-01	01-2191-01
140 mm – 5 ½ "	01-2190-02	01-2191-02
160 mm – 6 ¼ "	01-2190-03	01-2191-03
180 mm – 7 "	01-2190-04	01-2191-04

Needle holders.



MATHIEU



140 mm – 5 ½ "	01-2192-01	01-2193-01	01-2194-01
170 mm – 6 ¾ "	01-2192-02	01-2193-02	01-2194-02
200 mm – 8 "	01-2192-03	01-2193-03	01-2194-03
240 mm – 9 ½ "	01-2192-04		

grooved jaw

delicate pattern



MATHIEU

T.C	T.C	T.C	T.C
140 mm – 5 ½ "	170 mm – 6 ¾ "	200 mm – 8 "	240 mm – 9 ½ "
01-2195	01-2196	01-2197	01-2198



MATHIEU

T.C	T.C	T.C	T.C
140 mm – 5 ½ "	170 mm – 6 ¾ "	200 mm – 8 "	240 mm – 9 ½ "
01-2199	01-2200	01-2201	01-2202

delicate pattern

Needle holders



MATHIEU-OLSEN

		T.C
140 mm - 5 1/2 "	01-2203-01	01-2204-01
170 mm - 6 3/4 "	01-2203-02	01-2204-02
200 mm - 8 "	01-2203-03	01-2204-03



MATHIEU

			T.C
140 mm - 6 3/4 "			01-2207-01
170 mm - 6 3/4 "	01-2205-01	01-2206-01	01-2207-02
200 mm - 8 "	01-2205-02	01-2206-02	01-2207-03

grooved jaw

Needle holders



CASTROVIEJO-
JACOBSON



140 mm – 5 ½ "	01-2208-01	01-2209-01	01-2210-01	01-2211-01
180 mm – 7 "	01-2208-02	01-2209-02	01-2210-02	01-2211-02
210 mm – 8 ¼ "	01-2208-03	01-2209-03	01-2210-03	01-2211-03

smooth jaws straight, without ratchet straight, with ratchet curved, without ratchet curved, with ratchet



CASTROVIEJO-
JACOBSON

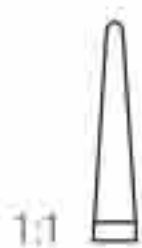

	T.C	T.C	T.C	T.C
140 mm – 5 ½ "	01-2212-01	01-2213-01	01-2214-01	01-2215-01
180 mm – 7 "	01-2212-02	01-2213-02	01-2214-02	01-2215-02
210 mm – 8 ¼ "	01-2212-03	01-2213-03	01-2214-03	01-2215-03

smooth jaws straight, without ratchet straight, with ratchet curved, without ratchet curved, with ratchet

Needle holders

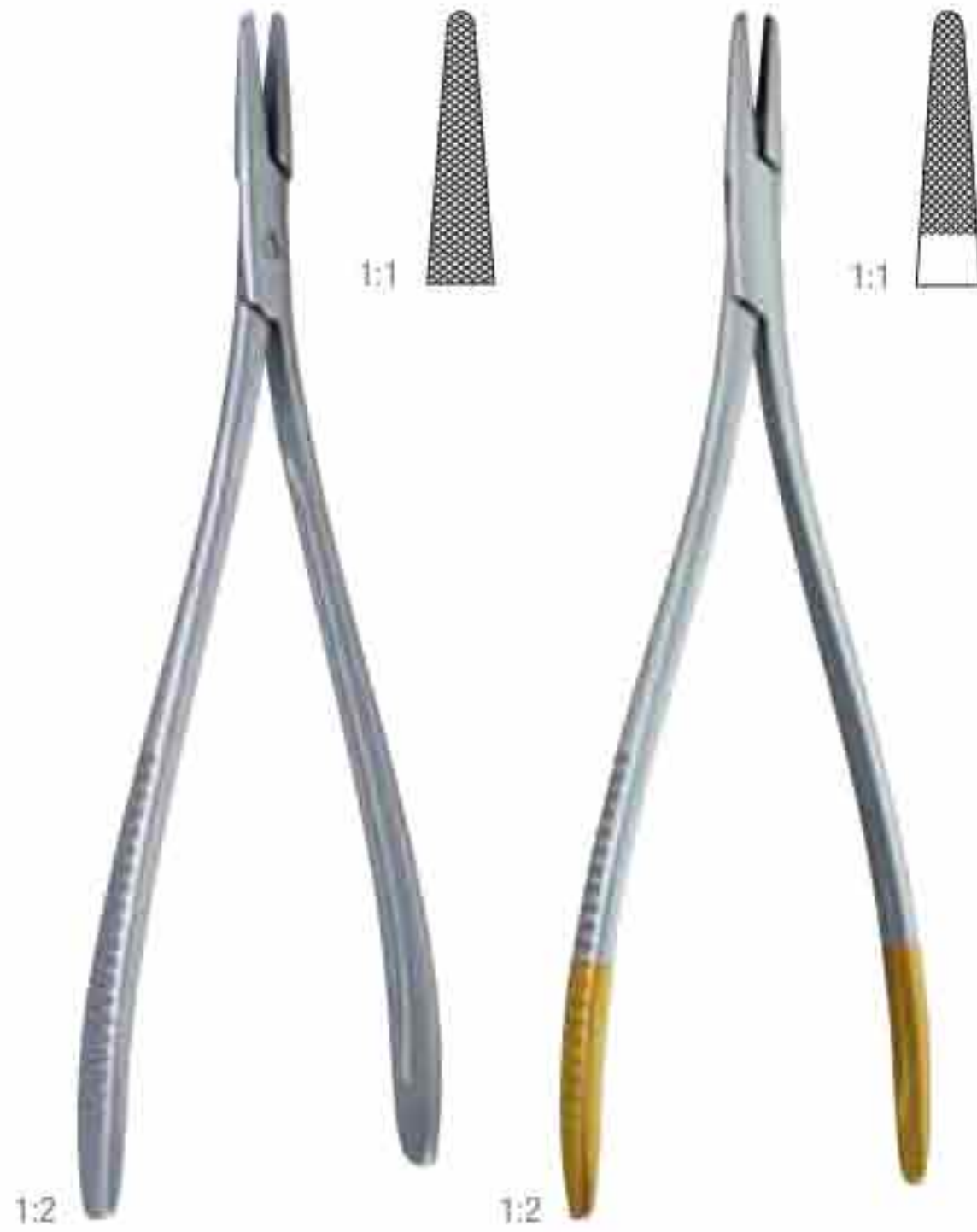

TOENNIS

		T.C
180 mm – 7"	01-2216	01-2217

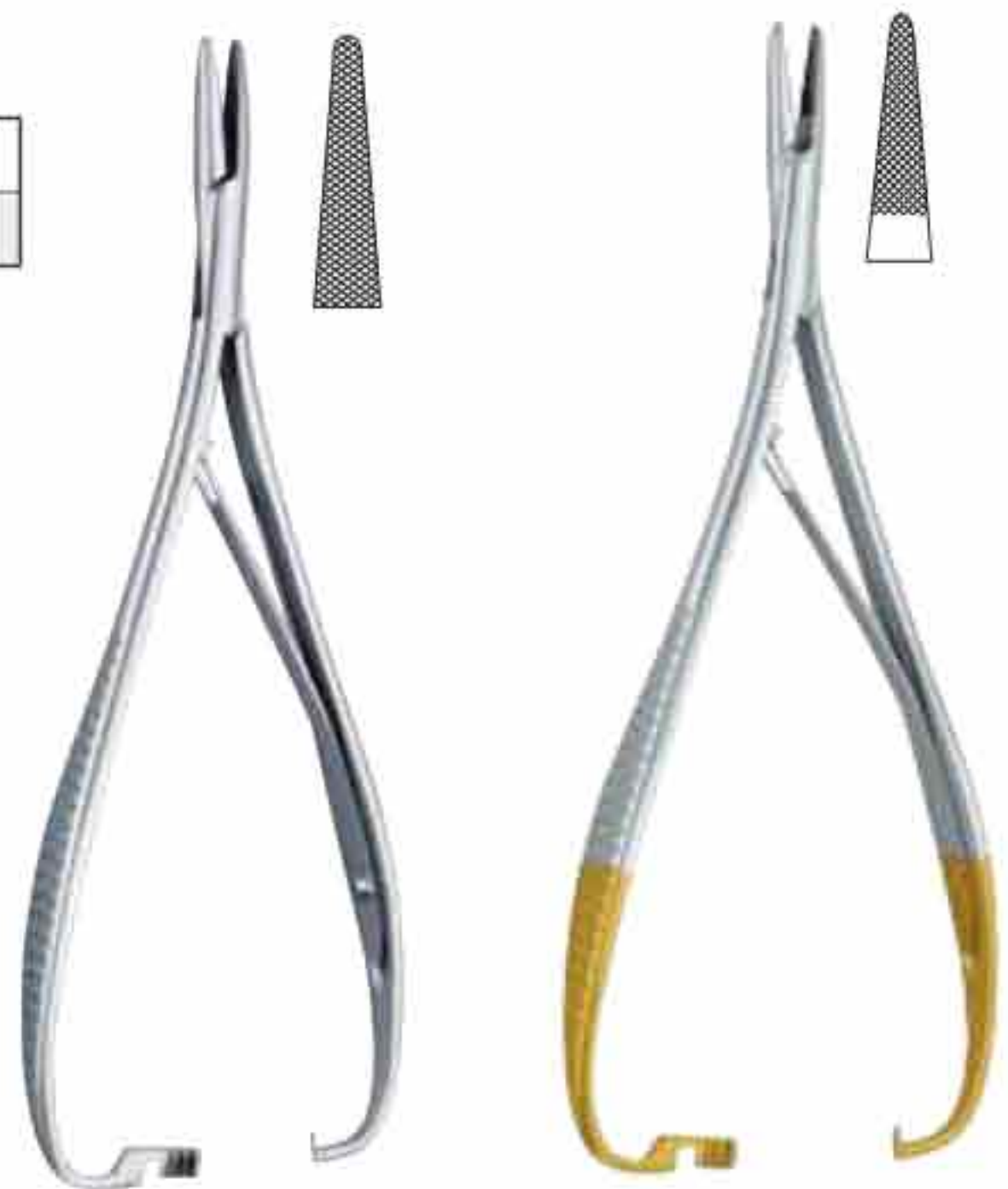

LICHTENBERG

		T.C
140 mm – 5 ½"		01-2219-01
170 mm – 6 ¾"	01-2218-01	01-2219-02
200 mm – 8"	01-2218-02	01-2219-03

Needle holders

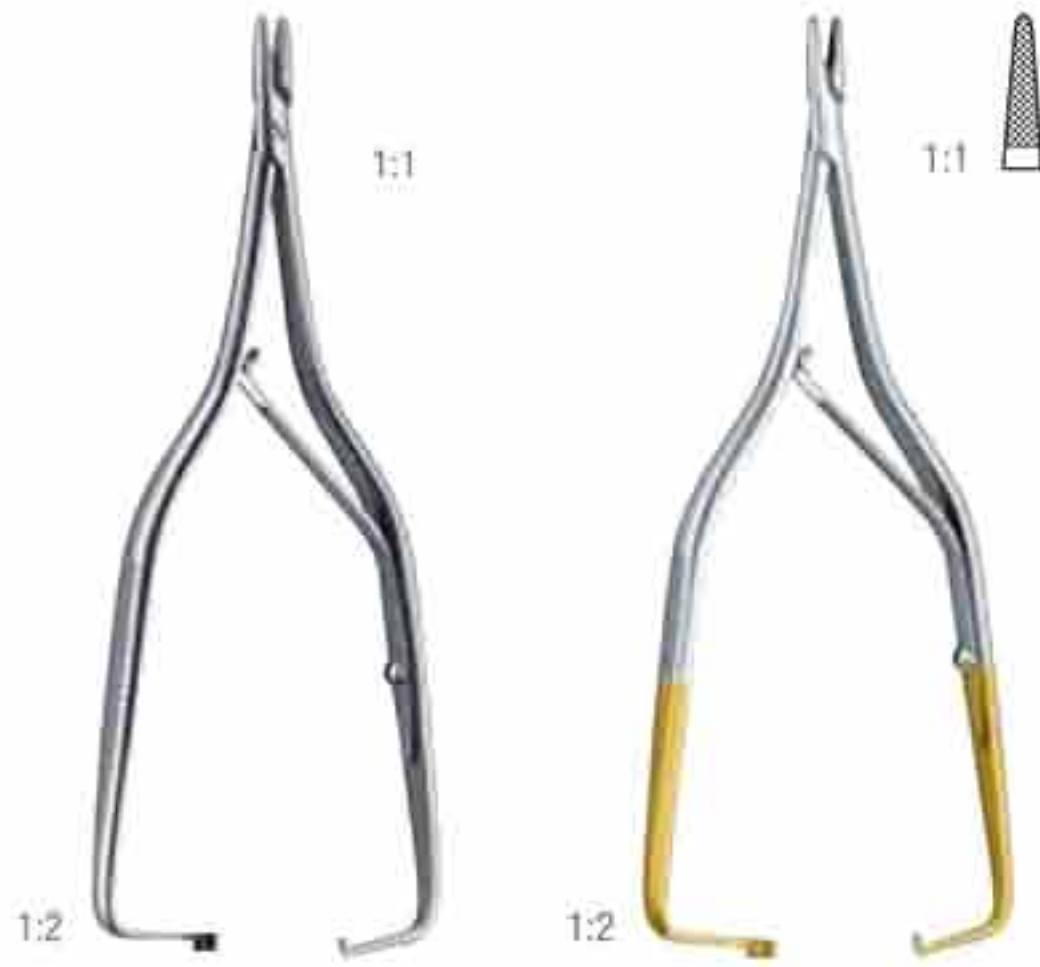

BOYNTON

		T.C
120 mm – 4 ¾ "	01-2220	01-2221

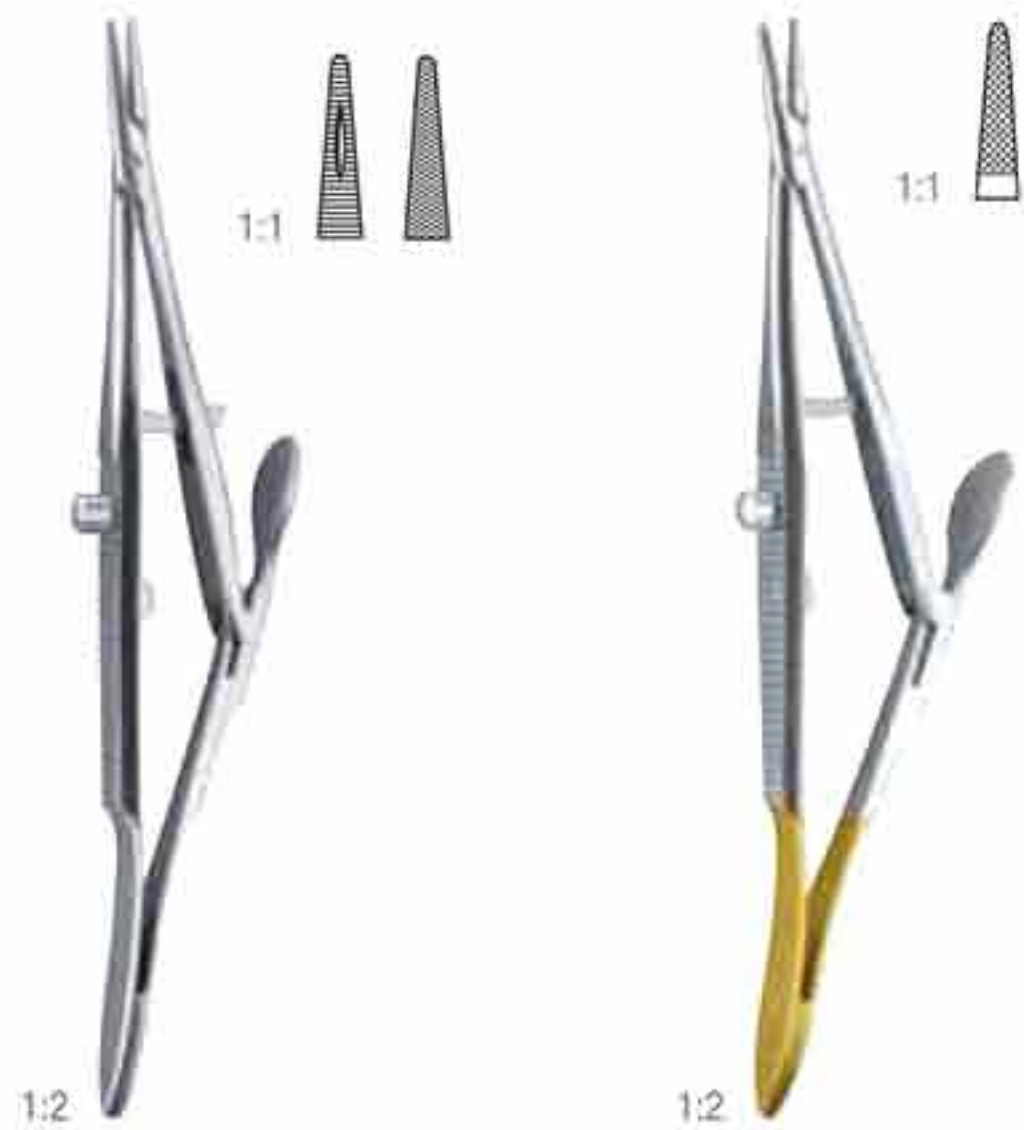

KALT

		T.C
140 mm – 5 ½ "	01-2222	01-2223



ARRUGA

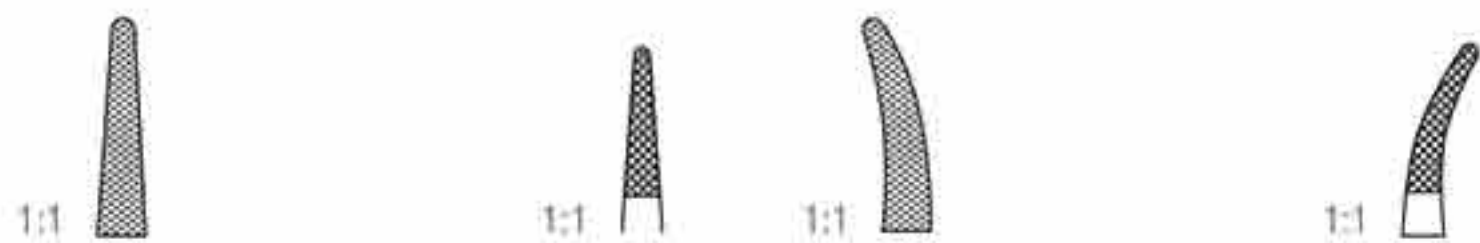

		T.C		T.C
160 mm – 6 ¼ "	01-2224	01-2225	01-2226	01-2227

straight

straight

curved

curved

Needle holders



RYDER

	T.C
130 mm – 5"	01-2228-01
150 mm – 6"	01-2228-02
180 mm – 7"	01-2228-03
200 mm – 8"	01-2228-04
230 mm – 9"	01-2228-05
260 mm – 10 ¼"	01-2228-06

MINI-RYDER



T.C
01-2229-01
01-2229-02
01-2229-03
01-2229-04
01-2229-05
01-2229-06

Needle holders



KILNER

		T.C
135 mm – 5 ¼ "	01-2230-01	01-2230-00
160 mm – 6 ¼ "	01-2230-02	



1:2

CONVERSE

	T.C
130 mm – 5 "	01-2231



HÖSEL

T.C	T.C
200 mm – 8 "	250 mm – 9 ¾ "
01-2232	01-2233

with long neck



T.C	T.C
205 mm – 8 "	260 mm – 10 ¼ "
01-2234	01-2235

with long neck

Needle holders

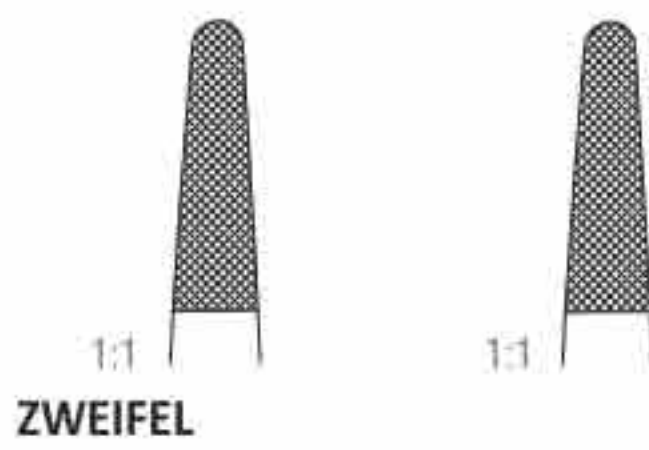

T.C	T.C
200 mm – 8"	230 mm – 9"
01-2236-01	01-2236-02



LANGENBECK

	T.C
140 mm – 5 ½"	01-2237-01
160 mm – 6 ¼"	01-2237-02
180 mm – 7"	01-2237-03
200 mm – 8"	01-2237-04
230 mm – 9"	01-2237-05

Needle holders

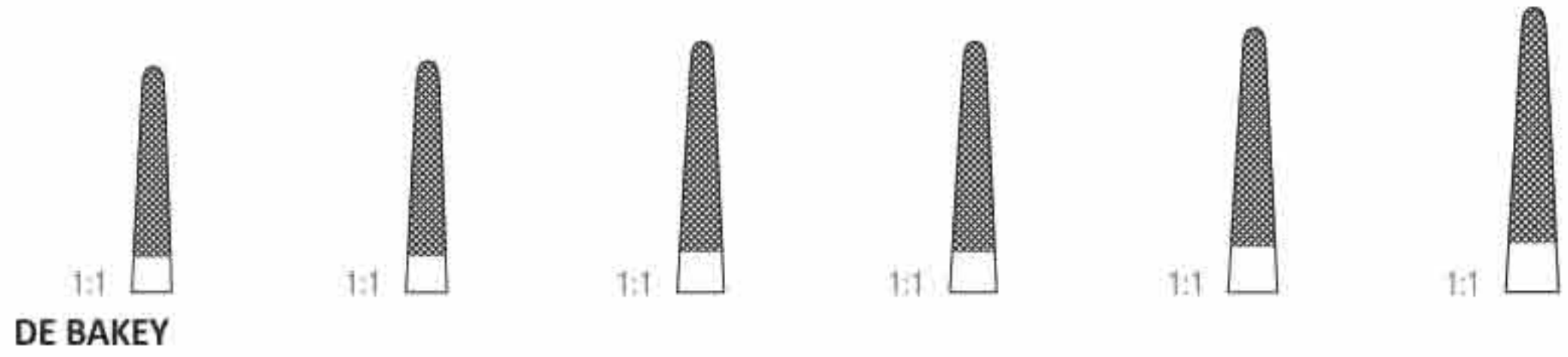

DE BAKEY

T.C	T.C	T.C	T.C	T.C	T.C
160 mm – 6 ¼ "	180 mm – 7 "	200 mm – 8 "	230 mm – 9 "	260 mm – 10 ¼ "	300 mm – 12 "
01-2238-01	01-2238-02	01-2238-03	01-2238-04	01-2238-05	01-2238-06



	T.C	T.C
150 mm – 6 "	01-2239-01	01-2240-01
180 mm – 7 "	01-2239-02	01-2240-02
200 mm – 8 "	01-2239-03	01-2240-03

Wire forceps

Needle holders

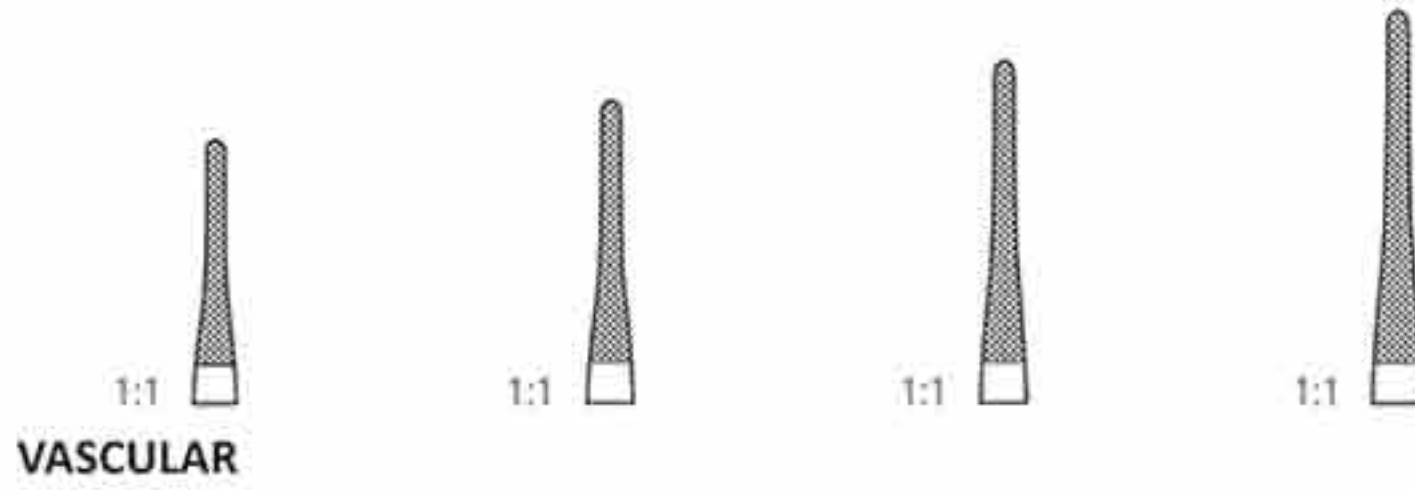

VASCULAR

T.C	T.C	T.C	T.C
140 mm – 5 ½ "	180 mm – 7 "	200 mm – 8 "	230 mm – 9 "
01-2241-01	01-2241-02	01-2241-03	01-2241-04



1:2

VASCULAR



	T.C	T.C	T.C	T.C
180 mm – 7 "	01-2242	01-2243	01-2244	01-2245

straight, without ratchet straight, with ratchet curved, without ratchet curved, with ratchet



DIETHRICH



	T.C
160 mm – 6 ¼ "	01-2246-01
180 mm – 7 "	01-2246-02
200 mm – 8 "	01-2246-03
230 mm – 9 "	01-2246-04
250 mm – 9 ¾ "	01-2246-05

Needle holders



CASTROVIEJO

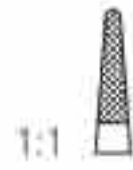

130 mm – 5"	01-2247	01-2248
-------------	---------	---------

straight, serrated jaws

curved, serrated jaws

CASTROVIEJO

	T.C	T.C
130 mm – 5"	01-2249	01-2250

straight, serrated jaws

curved, serrated jaws



CASTROVIEJO

	T.C
130 mm – 5"	01-2251

smooth jaws



BARRAQUER

	T.C	T.C
130 mm – 5"	01-2252	01-2253

curved, with ratchet

curved, without ratchet

Suture instruments



REVERDIN

	Fig. 1	Fig. 2	Fig. 3	Fig. 4
150 mm – 6 "	01-2254-01	01-2255-01	01-2256-01	01-2257-01
195 mm – 7 ¾ "	01-2254-02	01-2255-02	01-2256-02	01-2257-02
225 mm – 8 ¾ "	01-2254-03	01-2255-03	01-2256-03	01-2257-03



YOUNG

1:3

250 mm – 9 ¾ "	01-2258
----------------	---------

Complete with one needle

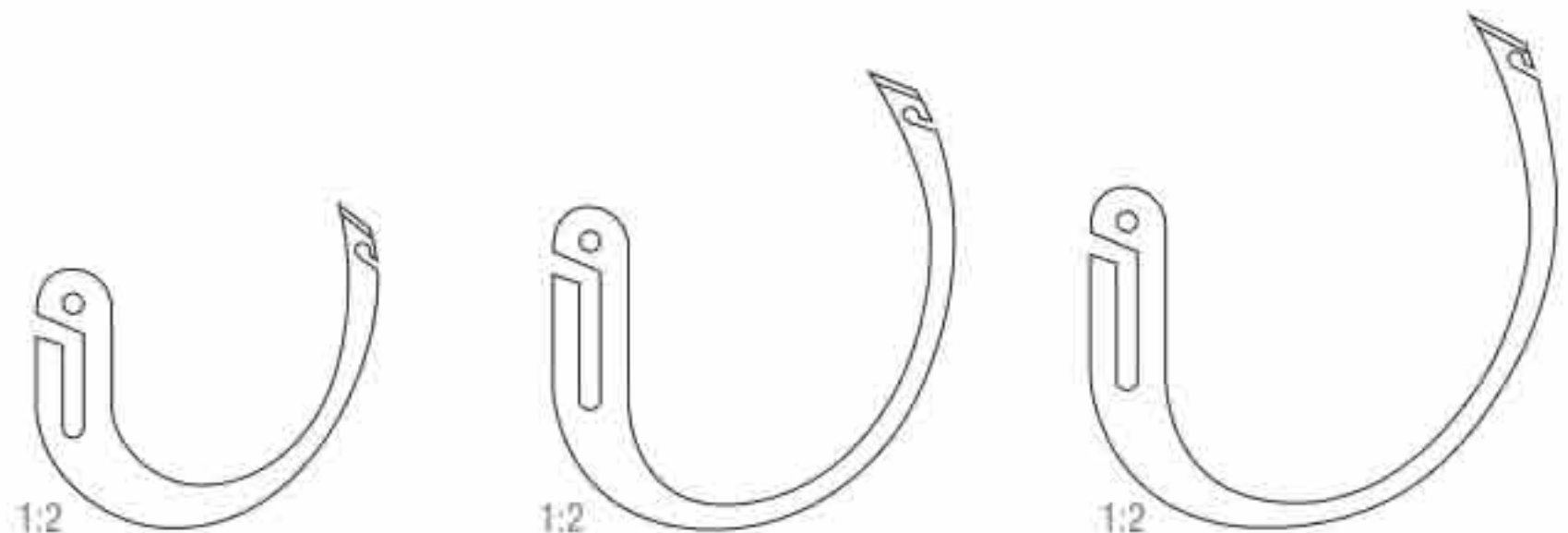

1:2

1:2

1:2

01-2259-01	01-2259-02	01-2259-03
------------	------------	------------

Spare needle

Suture instruments



flexible

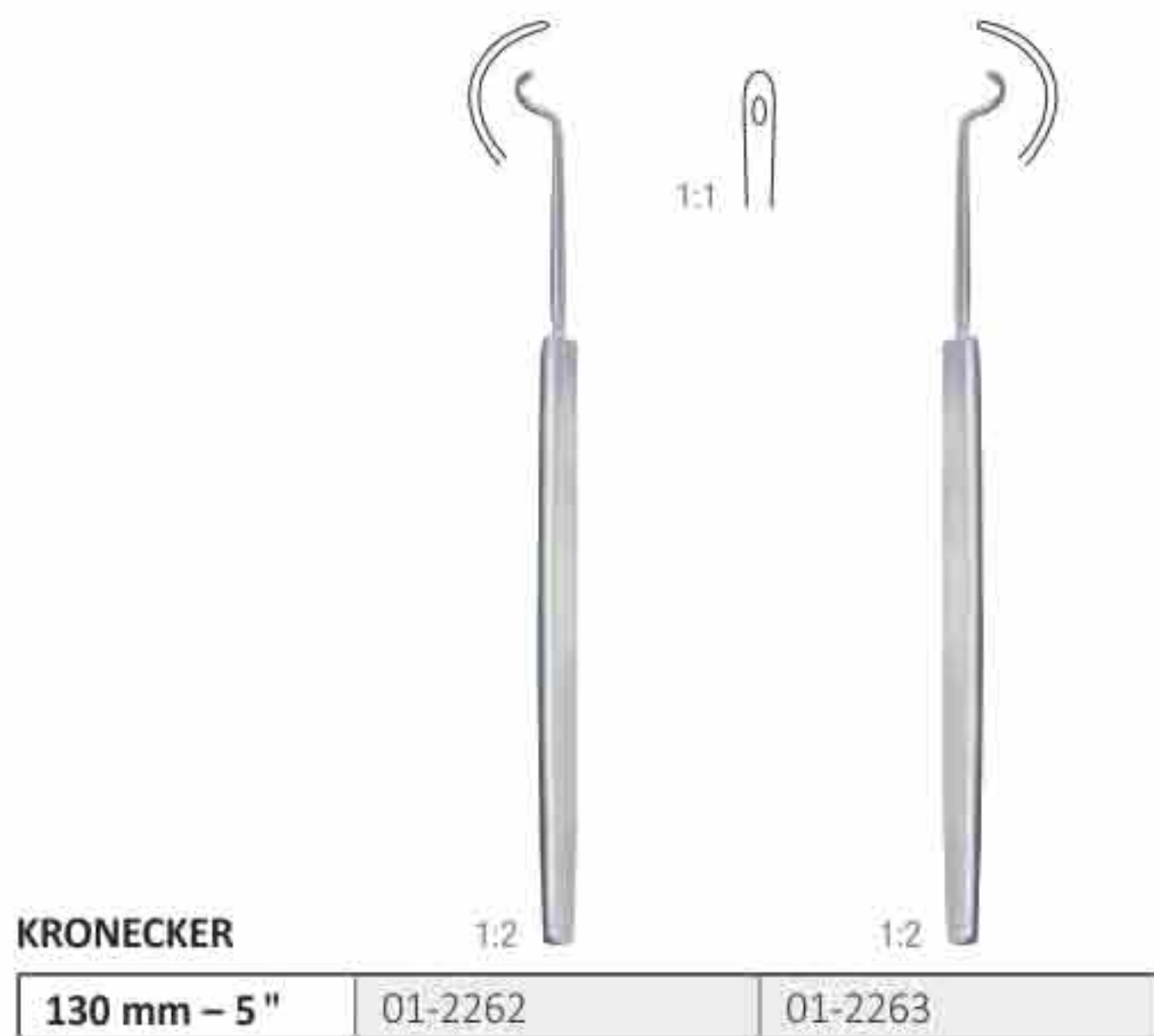
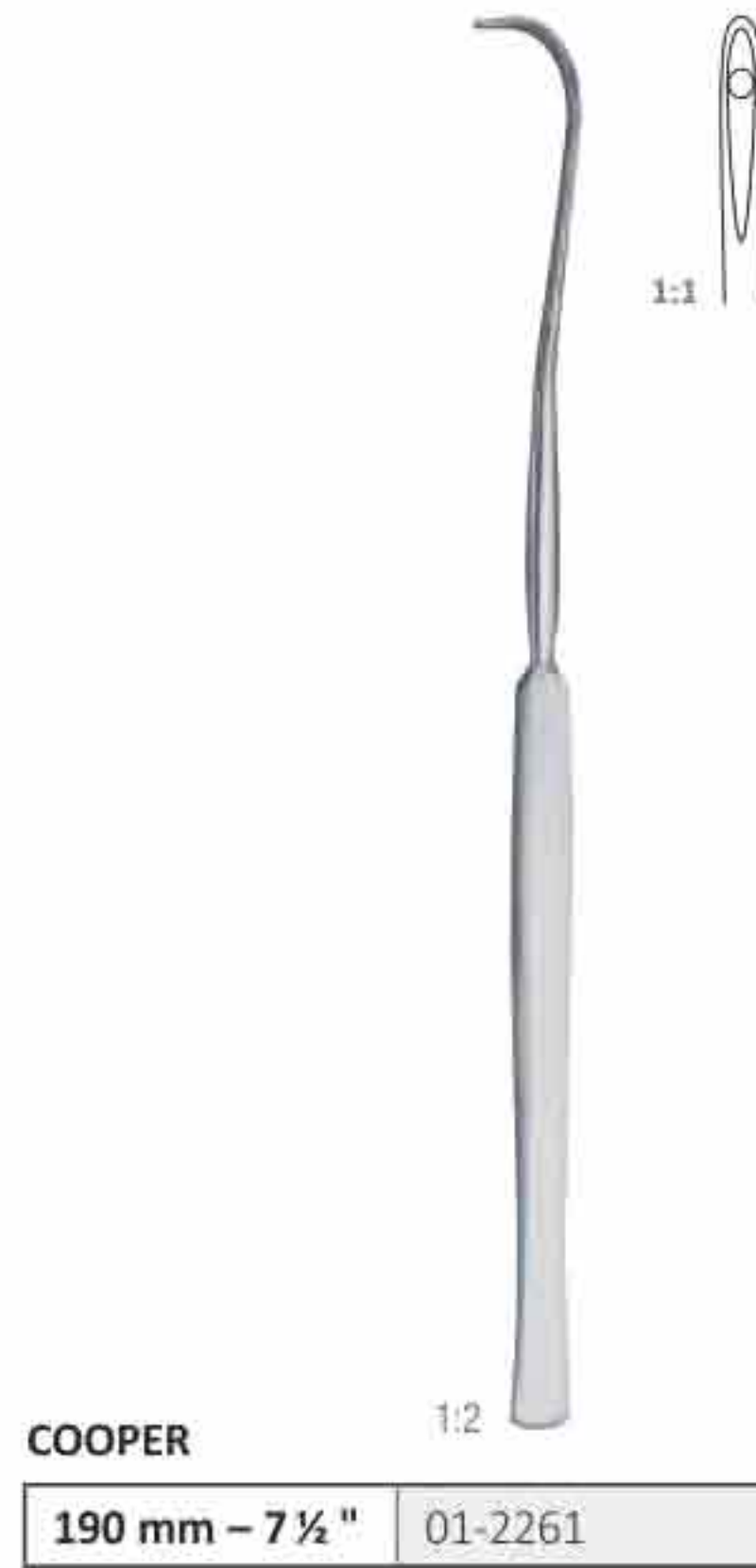

for right hand

for left hand

Ligature needles



DESCHAMPS

200 mm – 8"	01-2264-01	01-2265-01	01-2266-01	01-2267-01
240 mm – 9 ½"	01-2264-02	01-2265-02	01-2266-02	01-2267-02
270 mm – 10 ¾"	01-2264-03	01-2265-03	01-2266-03	01-2267-03

sharp
for right hand

sharp
for left hand

blunt
for right hand

blunt
for left hand

Suture instruments



ROTTER

1:1



1:1



1:1



1:1

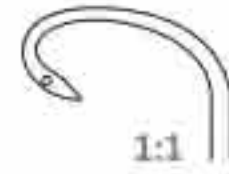

260 mm – 10 ¼"	01-2268-01	01-2268-02	01-2269-01	01-2269-01
-----------------------	------------	------------	------------	------------

for right hand

for left hand

for right hand

for left hand

1:2



SCHMIEDEN

1:2

210 mm – 8 ¼"	01-2270
----------------------	---------

1:1



CLAUS-EICKEN

1:2

230 mm – 9"	01-2271
--------------------	---------

1:1



CLAUS

1:2

230 mm – 9"	01-2272
--------------------	---------

Suture instruments



HURD

1:2

1:2

210 mm – 8 ¼ "	01-2273	01-2274
-----------------------	---------	---------

for right hand

for left hand



DUPUY-WEISS

1:2

1:2

220 mm – 8 ¼ "	01-2275	01-2276
-----------------------	---------	---------

for right hand

for left hand

Suture instruments



YANKAUER

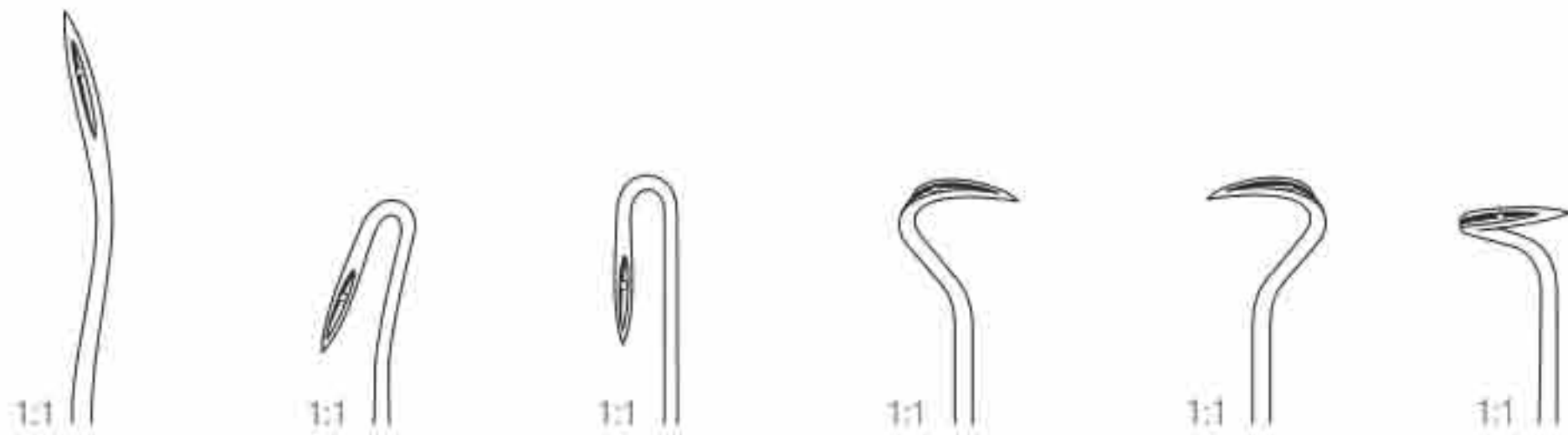

170 mm – 6 ¼ "	01-2277-01	01-2277-02	01-2277-03	01-2277-04	01-2277-05	01-2277-06
----------------	------------	------------	------------	------------	------------	------------

Septum suture needles



01-2277-07	01-2277-08	01-2277-09
------------	------------	------------



NAGER

1:2

240 mm – 9 ½ "	01-2278
----------------	---------



FALK

1:2

1:2

240 mm – 9 ½ "	01-2279	01-2280
----------------	---------	---------

for right hand

for left hand

Ligature conductors – Suture instruments



Ligature conductors – Suture instruments



BRUNNER

180 mm – 7"	01-2291-01
270 mm – 10 ¼"	01-2291-02

Ferrozell

1:2
KIRSCHNER

270 mm – 10 ¼"	01-2290
----------------	---------

Ferrozell

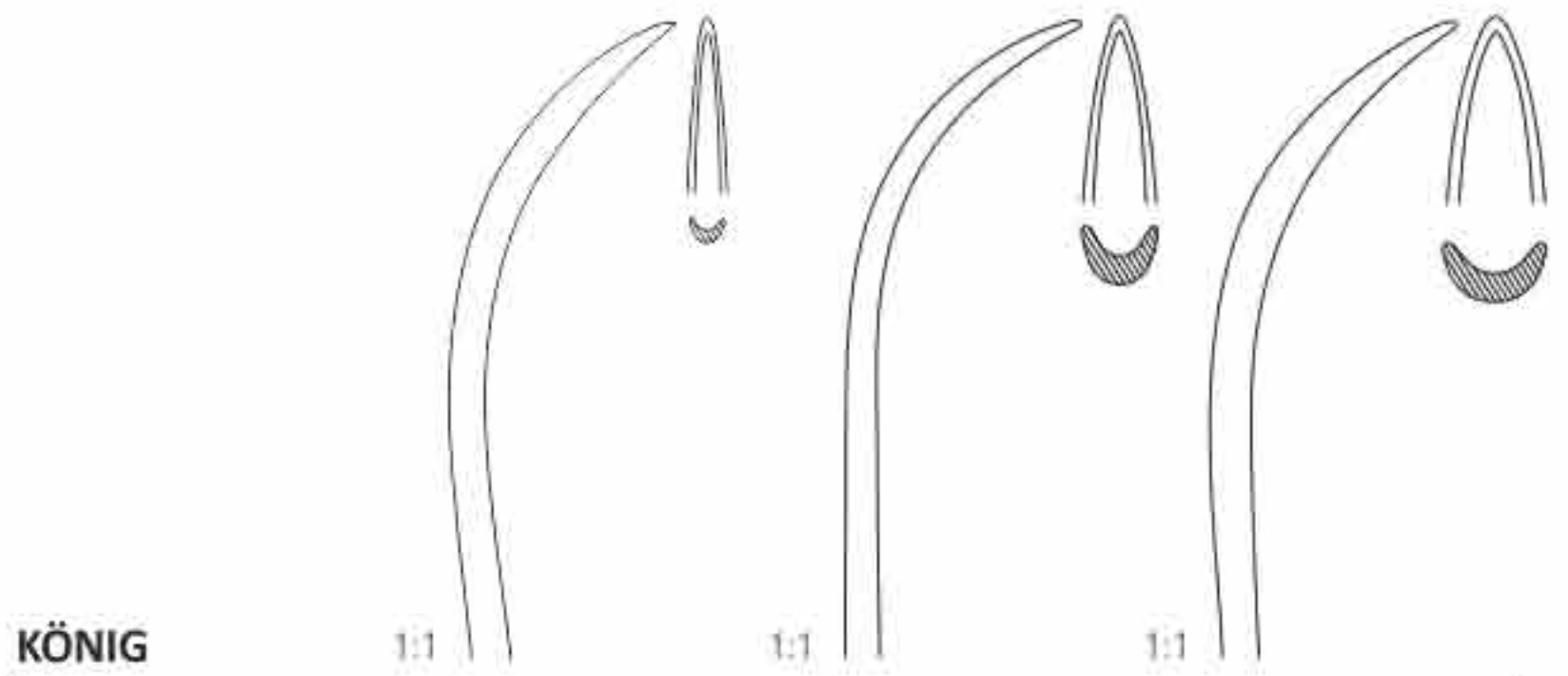

KÖNIG

	2.5 mm	5 mm	7 mm
190 mm – 7 ½"	01-2287	01-2288	
200 mm – 8"			01-2289



SCHMIEDEN

190 mm – 7 ½"
8 mm
01-2292

1:2



SCHMIEDEN-PAYR

190 mm – 7 ½"
8 mm
01-2293

1:2

Ligature conductors – Suture instruments

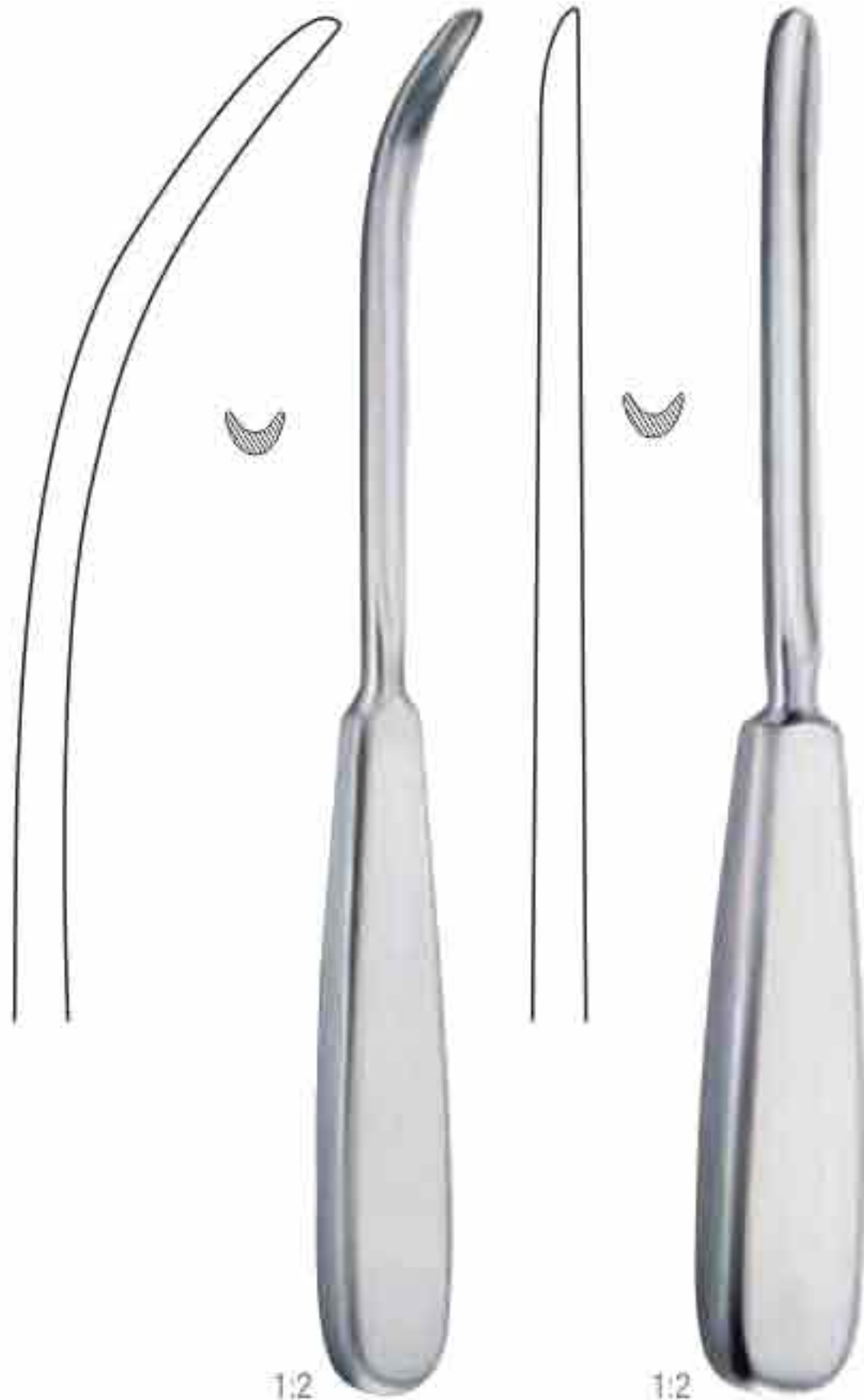

PAYR

1:2

1:2

	5 mm	5 mm
220 mm – 8 3/4 "	01-2294	01-2295



1:2

Mod. WIEN

235 mm – 9 1/4 "
01-2296

Ligature catcher



1:2

BOZEMANN

210 mm – 8 1/4 "
01-2297

Knot tier



1:2

230 mm – 9 "
01-2298

Ligature adjuster

Suture clip instruments



CHILDE 1:2

180 mm – 7"
01-2299

heavy pattern, with clip holder



MICHEL 1:2

120 mm – 4 ¾"	01-2300
---------------	---------



WACHENFELDT 1:2

125 mm – 5"	01-2301	01-2302
-------------	---------	---------



HEGENBARTH 1:2

125 mm – 5"	01-2303
-------------	---------



COLLIN 1:2

130 mm – 5"	01-2304
-------------	---------



RICHTER-HEATH 1:2

140 mm – 5 ½"	01-2305
---------------	---------

Suture clip instruments



MICHEI

1:2

120 mm – 4 ¾"	01-2306
---------------	---------



MICHEI

7.5 mm x 1.75 mm	11 mm x 2 mm	12 mm x 3 mm	14 mm x 3 mm
01-2307-01	01-2307-02	01-2307-03	01-2307-04

Unit for sale = 1.000 pieces (10 packages with 100 pieces)



MICHEI

16 mm x 3 mm	18 mm x 3 mm	20 mm x 3 mm	22 mm x 3 mm
01-2307-05	01-2307-06	01-2307-07	01-2307-08

Nasal hooks



KILNER 1:2

150 mm – 6"
01-2310



JOSEPH 1:2

150 mm – 6"
01-2311



LANGE 1:2

220 mm – 8 ¾"
01-2312



COTTLE 1:2

160 mm – 6 ¼"
01-2313



FOMON 1:2

170 mm – 6 ¾"
01-2314



COTTLE 1:2

150 mm – 6"



1:1

01-2315-01



1:1

01-2315-02



1:1

01-2315-03

Nasal hooks

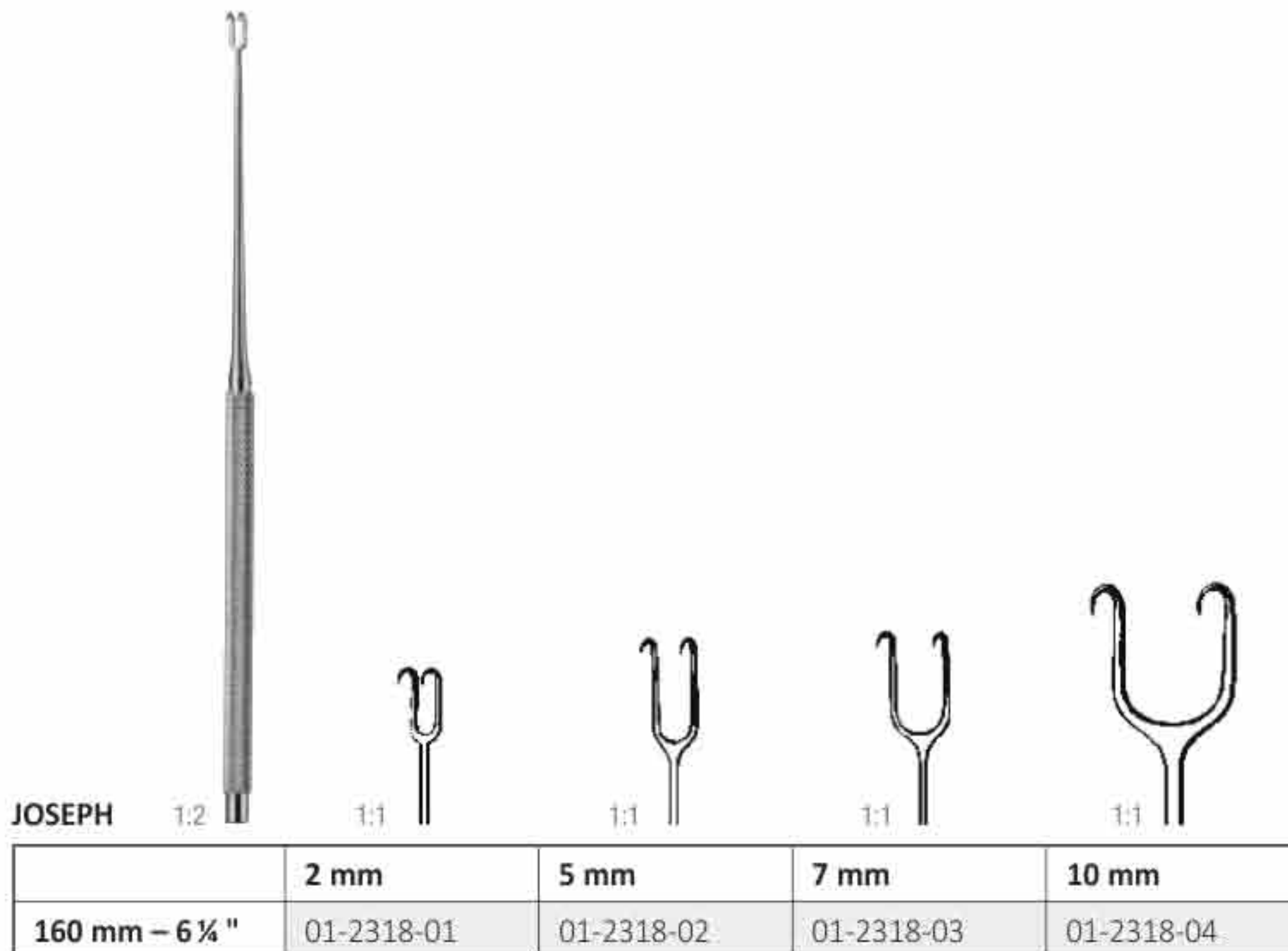
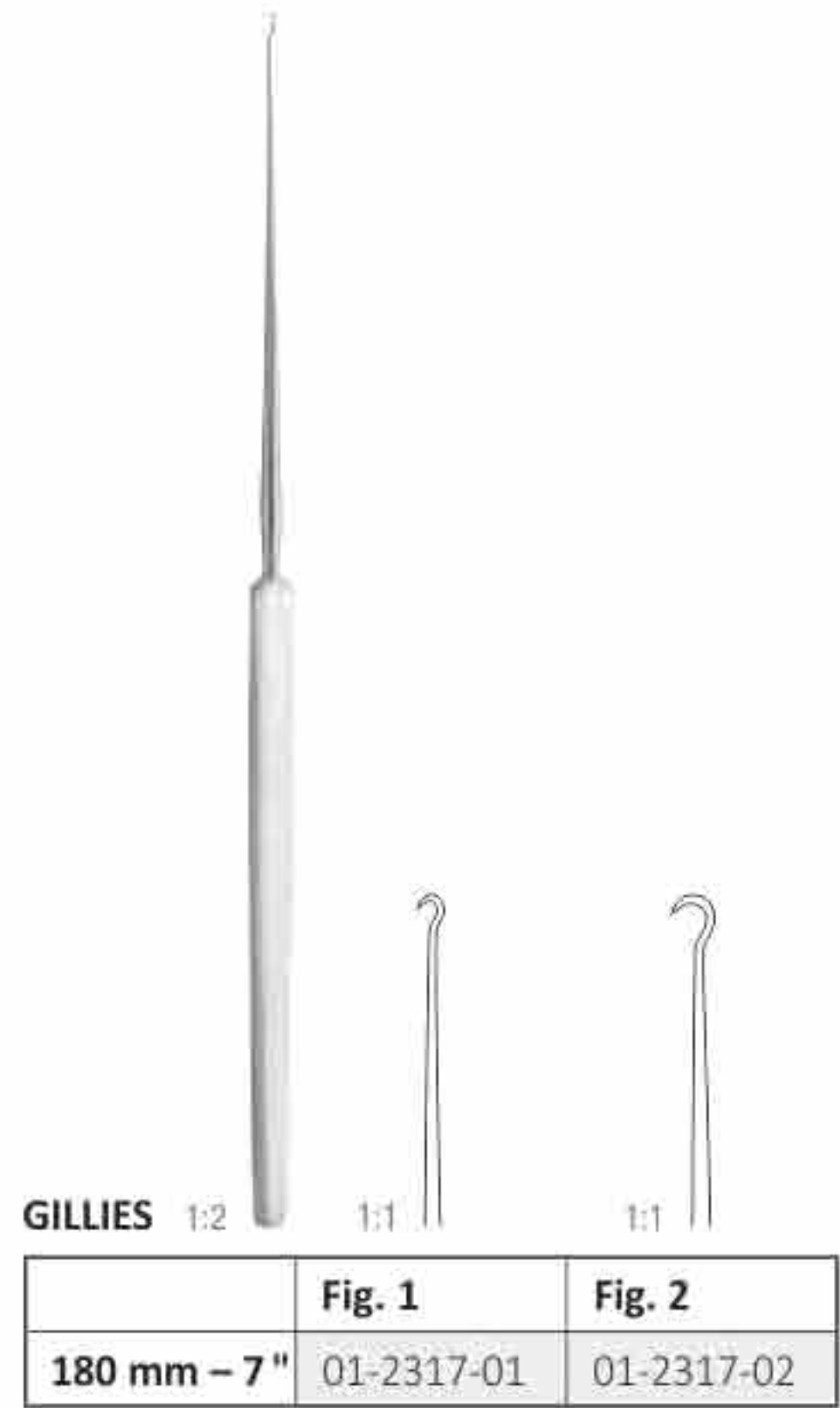
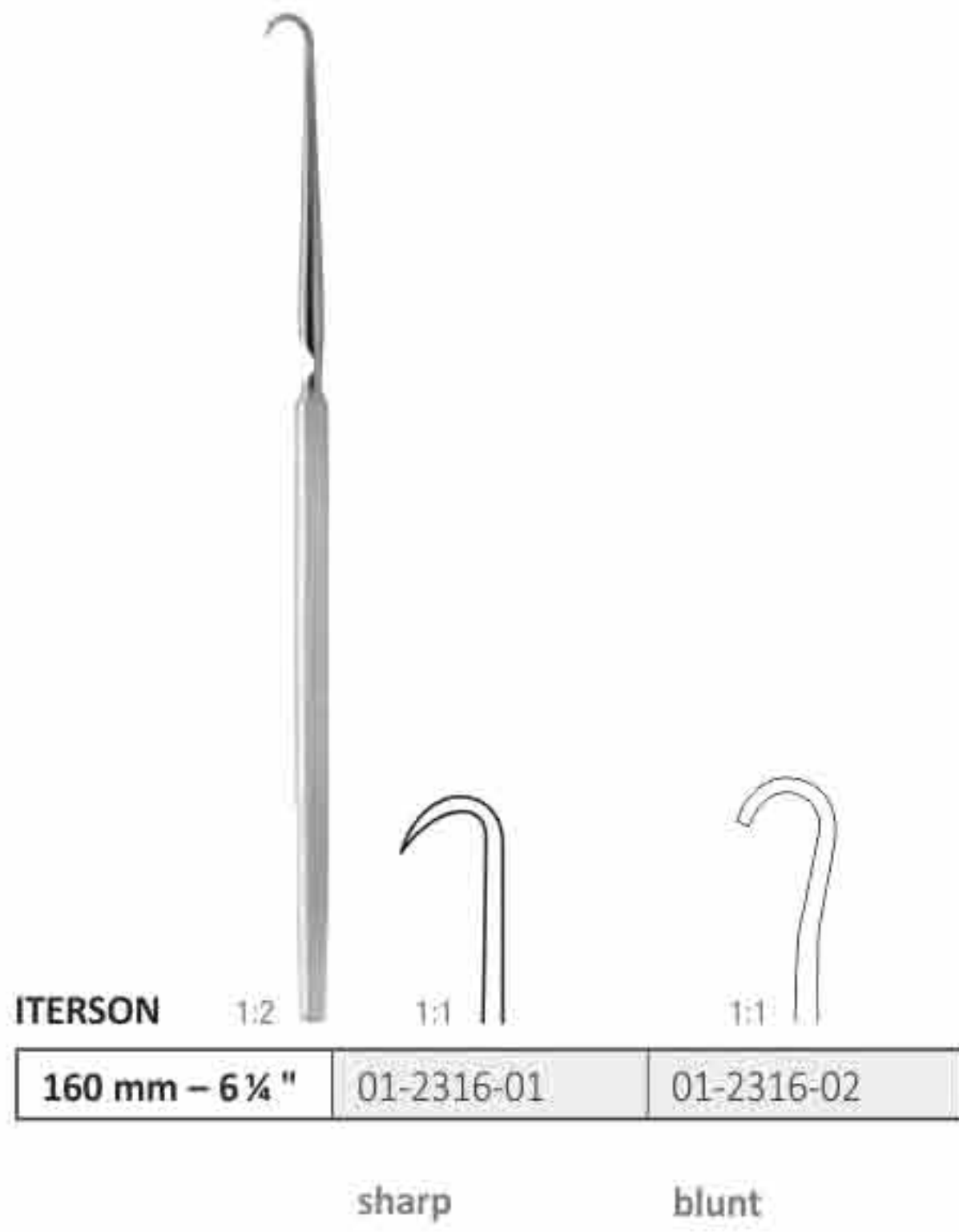

Nasal hooks



Cottle-Neivert 1:2
 200 mm – 8" 01-2319



FomoN 1:2
 160 mm – 6 ¼" 01-2320



Cottle 1:2
 150 mm – 6" 01-2321-01 01-2321-02 01-2321-03



Neivert 1:2
 160 mm – 6 ¼" 01-2322

Nose and trachea hooks



AUFRICHT

1:2

160 mm – 6 ¼ "	160 mm – 6 ¼ "
24-549-160	01-2323

with F.O. light carrier



KILNER

1:2

100 mm – 4 "	01-2324
--------------	---------



CONVERSE

1:2

120 mm – 4 ¾ "	01-2325
----------------	---------



COTTLE

1:2

1:2

150 mm – 6 "	01-2326	01-2327
--------------	---------	---------



JACKSON

1:2

150 mm – 6 "	01-2328
--------------	---------



LUKENS

1:2

170 mm – 6 ⅔ "	01-2329
----------------	---------

blunt

Trachea hooks



JACKSON 1:2

170 mm – 6 ² / ₃ "	01-2330
--	---------



JACKSON 1:2

180 mm – 7 "	01-2331	01-2332
--------------	---------	---------

blunt

sharp

Retractors



ROSE

1:2

130 mm - 5"	01-2333
-------------	---------



LUER

1:2

110 mm - 4 1/4"	01-2334
-----------------	---------



SCHOENBORN

1:2

210 mm - 8 1/4"	01-2335
-----------------	---------

Retractors



emmet



	Fig. 1	Fig. 2	Fig. 3	Fig. 4	Fig. 5
220 mm – 8 3/4 "	01-2336-01	01-2336-02	01-2336-03	01-2336-04	01-2336-05



160 mm – 6 1/4 "	01-2337-01	01-2337-02	01-2337-03	01-2337-04
-------------------------	------------	------------	------------	------------

sharp



160 mm – 6 1/4 "	01-2338-01	01-2338-02	01-2338-03	01-2338-04
-------------------------	------------	------------	------------	------------

blunt

Retractors

160 mm – 6 ¼ "	01-2339-01	01-2339-02	01-2339-03

flexible, sharp

160 mm – 6 ¼ "	01-2340-01	01-2340-02	01-2340-03

flexible, blunt

DESMARRES

	x = 8 mm	x = 10 mm	x = 12 mm
160 mm – 6 ¼ "	01-2341-01	01-2341-02	01-2341-03

	x = 14 mm	x = 16 mm	x = 18 mm
160 mm – 6 ¼ "	01-2342-01	01-2342-02	01-2342-03

KNAPP (ROLLET)

160 mm – 6 ¼ "	01-2343	01-2344	01-2345

flexible, sharp 2 Teeth 3 Teeth 4 Teeth

Retractors



MINI-LANGENBECK



	10 mm x 6 mm	17 mm x 5 mm	20 mm x 6 mm	22 mm x 8 mm
160 mm – 6 ¼"	01-2346-01	01-2346-02	01-2346-03	01-2346-04

1:2



KOCHER



220 mm – 8 ¾"	01-2347-01	01-2347-02	01-2347-03	01-2347-04	01-2347-05	01-2347-06
----------------------	------------	------------	------------	------------	------------	------------

sharp



220 mm – 8 ¾"	01-2348-01	01-2348-02	01-2348-03	01-2348-04	01-2348-05	01-2348-06
----------------------	------------	------------	------------	------------	------------	------------

blunt









220 mm – 8 ¾"	01-2349-01	01-2349-02	01-2349-03	01-2349-04	01-2349-05	01-2349-06
----------------------	------------	------------	------------	------------	------------	------------





semi-sharp

1:2





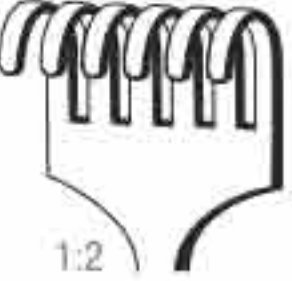

Retractors

					
VOLKMANN 1:1	1:2	1:2	1:2	1:2	1:2
215 mm – 8 ½ "	01-2350-01	01-2350-02	01-2350-03	01-2350-04	01-2350-05

sharp

					
1:1	1:2	1:2	1:2	1:2	1:2
215 mm – 8 ½ "	01-2351-01	01-2351-02	01-2351-03	01-2351-04	01-2351-05

blunt

					
1:1	1:2	1:2	1:2	1:2	1:2
215 mm – 8 ½ "	01-2352-01	01-2352-02	01-2352-03	01-2352-04	01-2352-05

semi-sharp



Retractors



VOLKMANN

215 mm – 8 ½ "	01-2353-01	01-2353-02
----------------	------------	------------

sharp

blunt

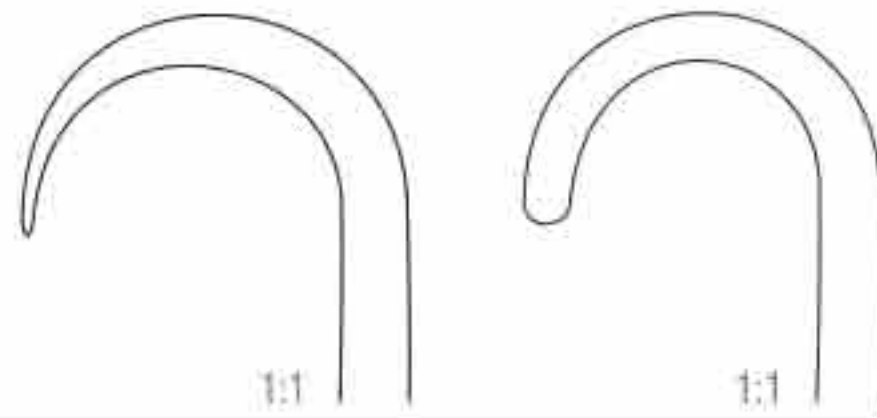

SENN-MUELLER

160 mm – 6 ¼ "	01-2354-01	01-2354-02
----------------	------------	------------

sharp

blunt

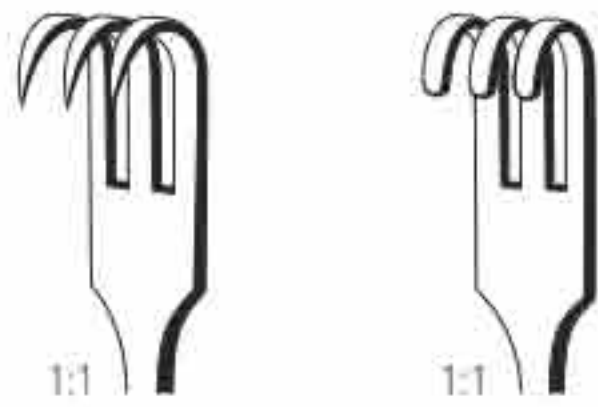

KILNER

155 mm – 6 "	01-2354-03
--------------	------------



Retractors

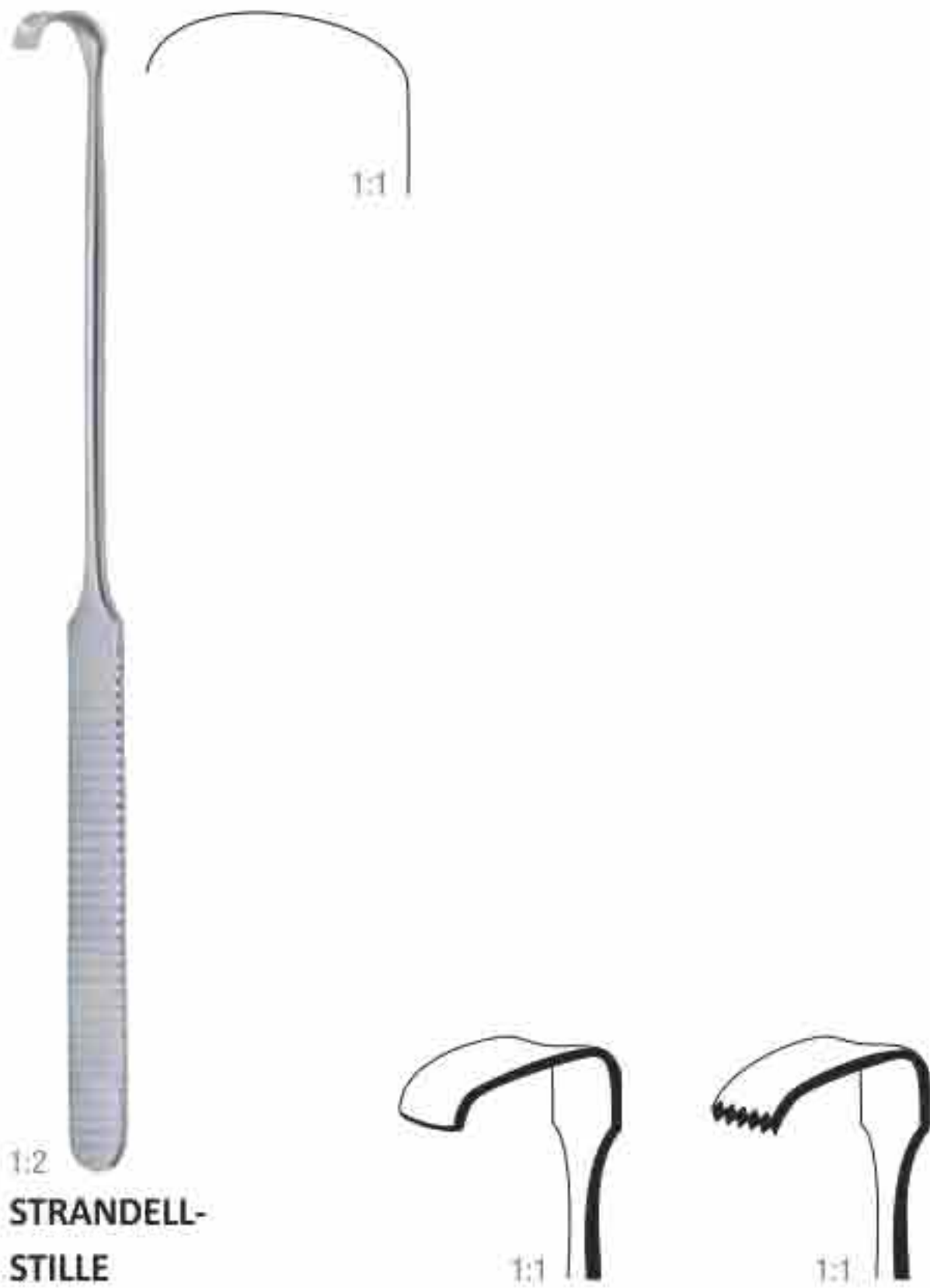

1:2
**STRANDELL-
STILLE**

	20 mm x 6 mm	20 mm x 6 mm
190 mm – 7 ½"	01-2355-01	01-2355-02

saw edge.

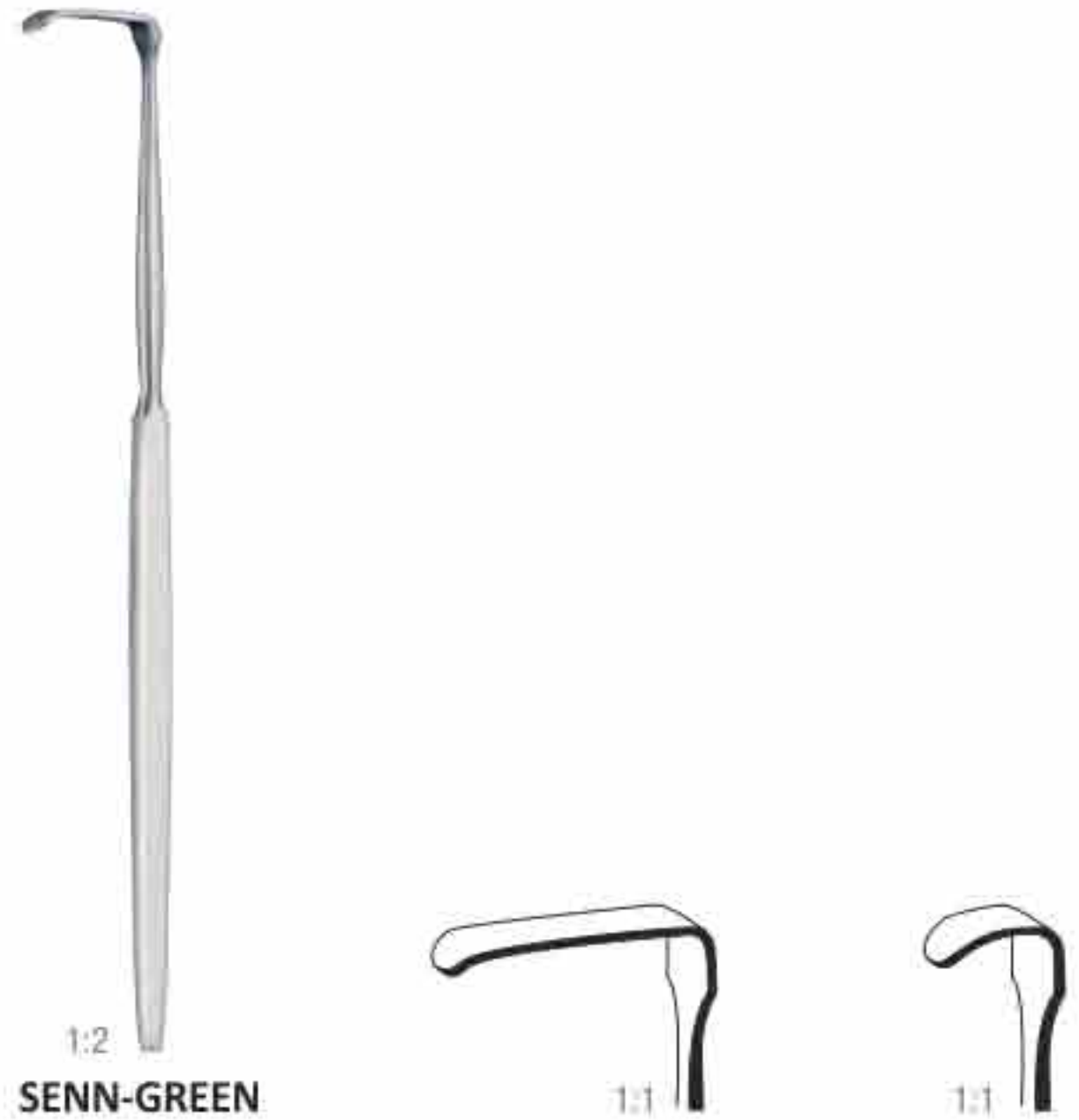

1:2
SENN-GREEN

	20 mm x 6 mm	10 mm x 6 mm
150 mm – 6"	01-2356-01	01-2356-02



**RAGNELL-
DAVIS** 1:2

140 mm – 5 ½"
01-2357



COTTLE 1:2

150 mm – 6"
01-2358



CRILE 1:2

110 mm – 4 ¼"
01-2359

Retractors

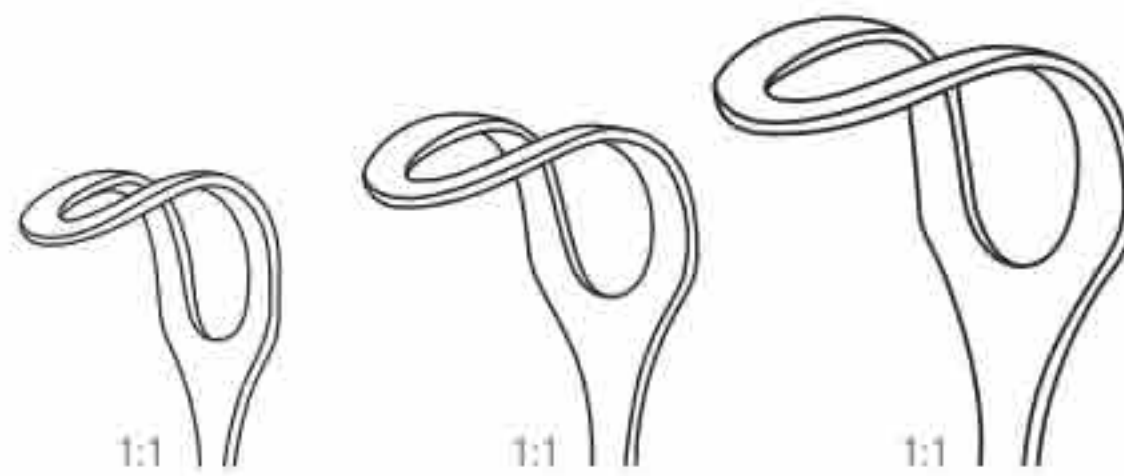

MIDDELDORPF

14 mm x 17 mm	20 mm x 22 mm	26 mm x 30 mm
215 mm – 8 ½ "	220 mm – 8 ¾ "	235 mm – 9 ¼ "
01-2360-01	01-2360-02	01-2360-03



MEYERDING



	18 mm x 7 mm	16 mm x 5 mm
180 mm – 7 "	01-2361-01	01-2361-02



	7 mm x 4 mm	7 mm x 4 mm
180 mm – 7 "	01-2362-01	01-2362-02



	10 mm x 3 mm	10 mm x 4 mm
180 mm – 7 "	01-2363-01	01-2363-02

Retractors



KOERTE

1:2



1:1



1:1

	26 mm x 40 mm	26 mm x 40 mm
235 mm – 9 ¼"	01-2364-01	01-2364-02

sharp

blunt



GREEN

1:2

215 mm – 8 ½"	01-2365
---------------	---------

Retractors



israel

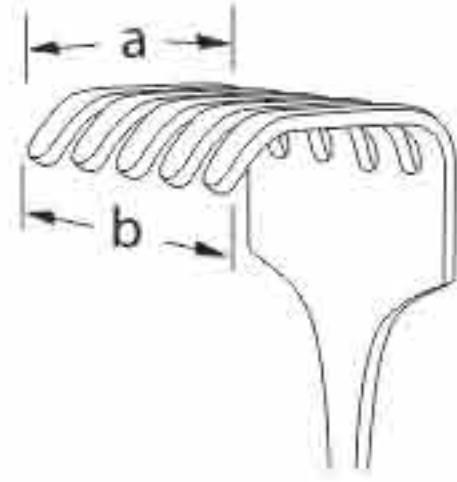

	a = 40 mm – b = 40 mm	a = 45 mm – b = 50 mm
250 mm – 9 3/4"	01-2366-01	01-2366-02

4 Teeth

5 Teeth

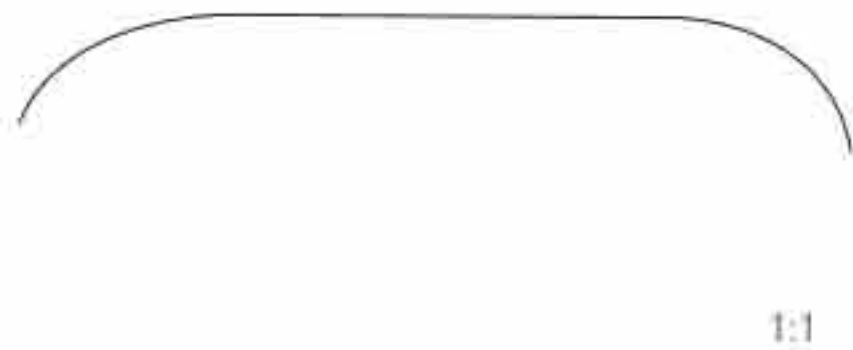

	a = 50 mm – b = 60 mm	a = 70 mm – b = 70 mm
250 mm – 9 3/4"	01-2366-03	01-2366-04

6 Teeth

6 Teeth

laNgeNbeCK

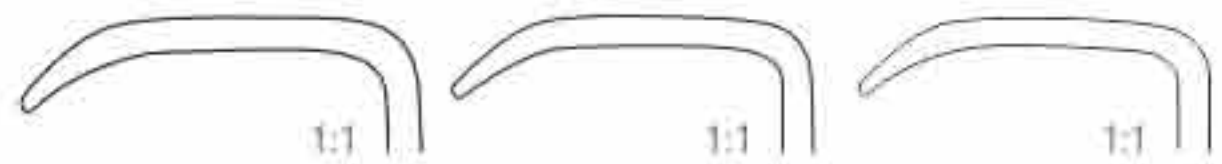

	Fig. 1	Fig. 2	Fig. 3
	30 mm x 11 mm	30 mm x 14 mm	30 mm x 16 mm
220 mm – 8 3/4"	01-2367-01	01-2367-02	01-2367-03



	Fig. 4	Fig. 5
	40 mm x 11 mm	50 mm x 11 mm
220 mm – 8 3/4"	01-2367-04	01-2367-05



1:2

Retractors



LANGENBECK

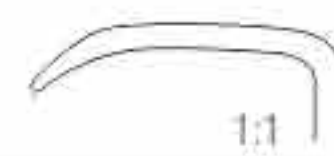

	Fig. 1	Fig. 2	Fig. 3
	30 mm x 11 mm	30 mm x 14 mm	30 mm x 16 mm
210 mm – 8 ¼ "	01-2368-01	01-2368-02	01-2368-03



	Fig. 4	Fig. 5
	40 mm x 11 mm	50 mm x 11 mm
210 mm – 8 ¼ "	01-2368-04	01-2368-05



KOCHER-LANGENBECK
(OBWEGESER)



	25 mm x 6 mm	35 mm x 8 mm	35 mm x 11 mm	35 mm x 15 mm
215 mm – 8 ½ "	01-2369-01	01-2369-02	01-2369-03	01-2369-04



	42 mm x 11 mm	55 mm x 11 mm	70 mm x 14 mm
215 mm – 8 ½ "	01-2369-05	01-2369-06	01-2369-07



	80 mm x 12 mm	80 mm x 16 mm
215 mm – 8 ½ "	01-2369-08	01-2369-09

Retractors



CUSHING



	x = 8 mm	x = 10 mm	x = 12 mm	x = 14 mm	x = 16 mm	x = 18 mm
200 mm – 8"	01-2370-01	01-2371-01	01-2372-01	01-2373-01	01-2374-01	01-2375-01
240 mm – 9 ½"	01-2370-02	01-2371-02	01-2372-02	01-2373-02	01-2374-02	01-2375-02



OBWEGESER



	40 mm x 11 mm	55 mm x 11 mm
220 mm – 8 ¾"	01-2376-01	01-2376-02



	80 mm x 16 mm
220 mm – 8 ¾"	01-2376-03

Retractors



OBWEGESER

	42 mm x 10 mm	70 mm x 11 mm
220 mm – 8 ¾"	01-2377-01	01-2377-02



OBWEGESER

155 mm – 6"	01-2378
-------------	---------



OBWEGESER

	x = 8 mm	x = 10 mm
160 mm – 6 ¼"	01-2379-01	01-2379-02

malleable

Retractors

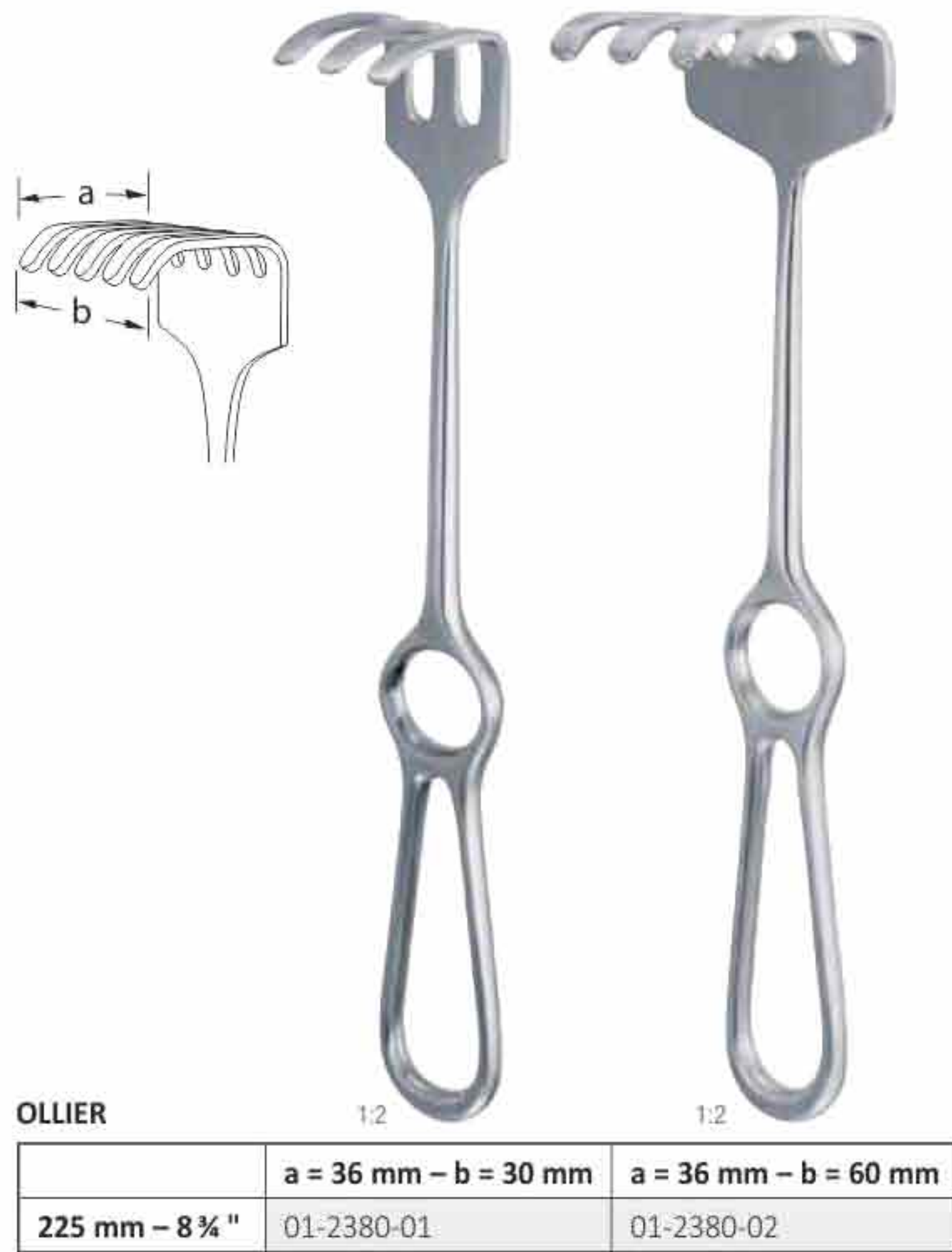

Retractors



KOCHER 1:2

	25 mm x 8 mm	55 mm x 11 mm	40 mm x 12 mm	75 mm x 12 mm	85 mm x 12 mm	100 mm x 12 mm
210 mm – 8 ¼ "	01-2381-01	01-2381-02	01-2381-03	01-2381-04	01-2381-05	01-2381-06



1:2

LANGENBECK

	55 mm x 20 mm	60 mm x 20 mm
210 mm – 8 ¼ "	01-2382-01	01-2382-02



1:2

LANGENBECK

	85 mm x 15 mm
210 mm – 8 ¼ "	01-2383

Handle vertical to the blade

Retractors

SAUERBRUCH

	45 mm x 15 mm	60 mm x 23 mm
225 mm – 8 ¾"	01-2384-01	01-2384-02



	75 mm x 20 mm
220 mm – 8 ¾"	01-2384-03



LAHEY

190 mm – 7 ½"
28 mm x 6 mm
01-2385



KOCHER

	19 mm x 12 mm	21 mm x 14 mm
190 mm – 7 ½"	01-2386-01	01-2386-02

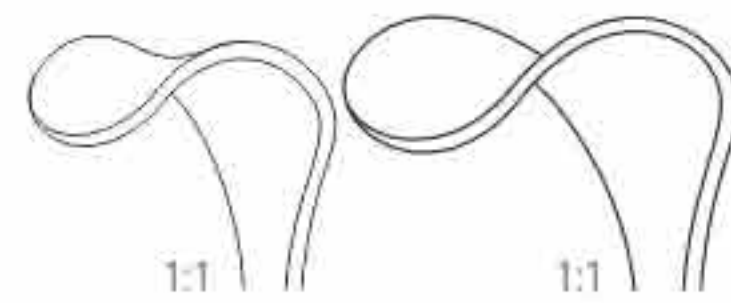

KOCHER

	40 mm x 10 mm	40 mm x 15 mm	40 mm x 20 mm
220 cm – 8 ¾"	01-2387-01	01-2387-02	01-2387-03

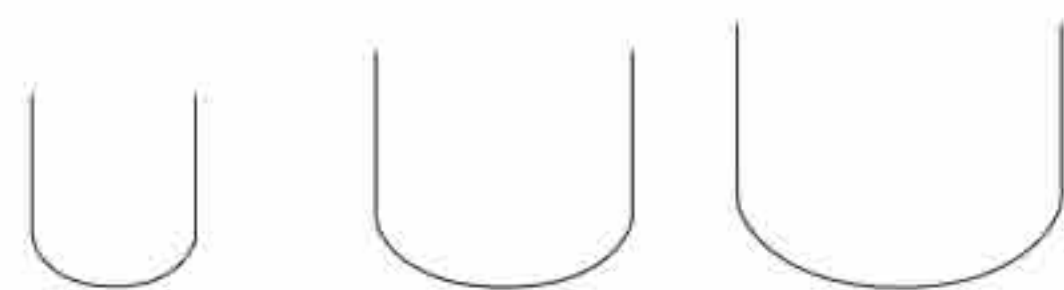





Retractors

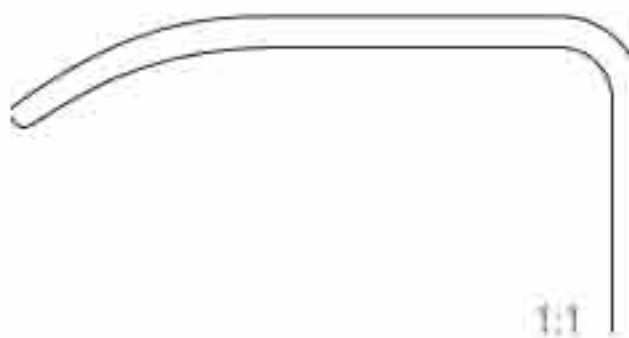

1:2

KOCHER

	 1:1	 1:1
	40 mm x 18 mm	60 mm x 20 mm
230 mm – 9"	01-2388-01	01-2388-02

	 1:1	 1:1
	60 mm x 25 mm	75 mm x 30 mm
230 mm – 9"	01-2388-03	01-2388-04

	 1:1
	75 mm x 40 mm
230 mm – 9"	01-2388-05



1:2

RICHARDSON

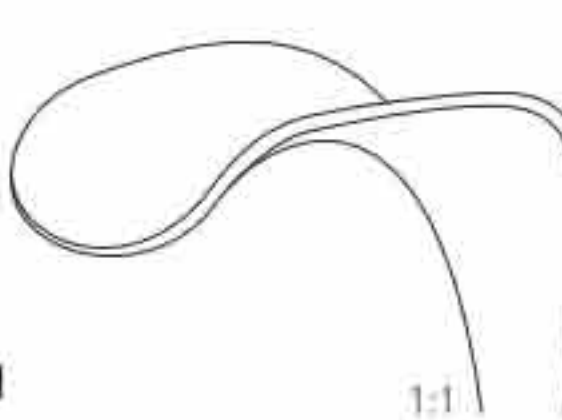
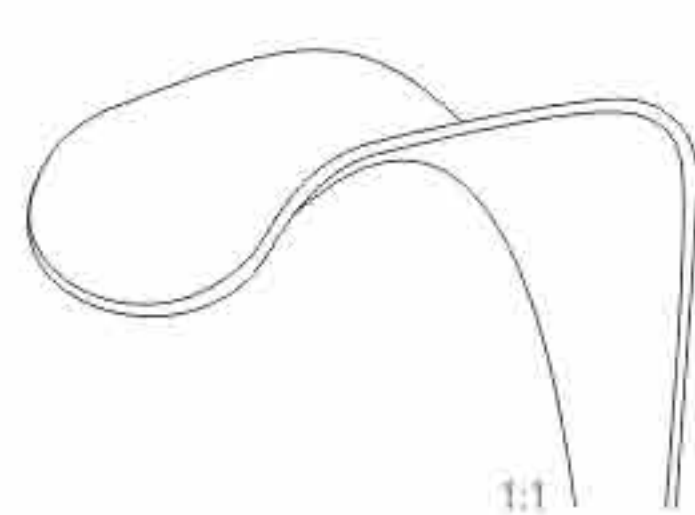
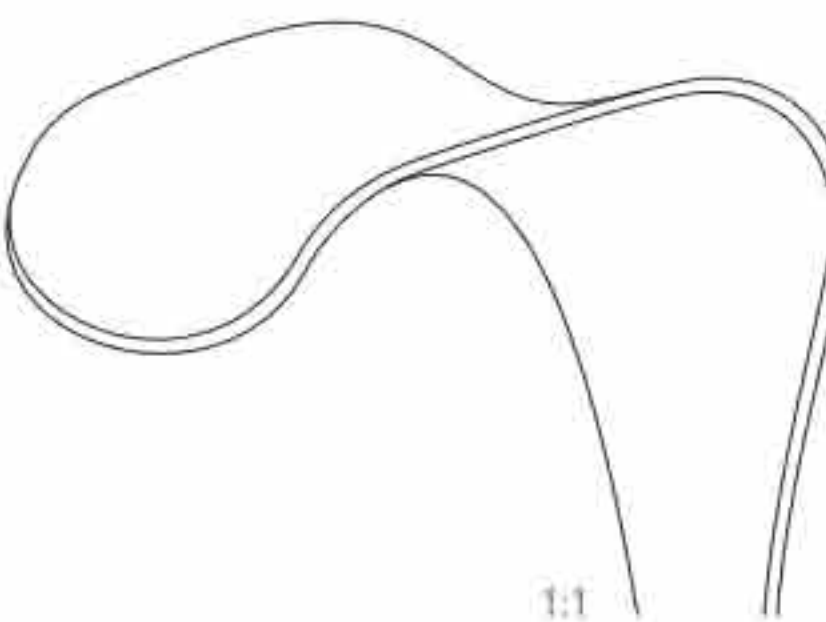
	 1:1	 1:1	 1:1
	25 mm x 20 mm	36 mm x 28 mm	44 mm x 38 mm
240 mm – 9 ½"	01-2389-01	01-2389-02	01-2389-03

Retractors



1:2

RICHARDSON-EASTMAN

	Fig. 1	Fig. 2
	280 mm – 11 "	260 mm – 10¼ "
	49 mm x 38 mm	36 mm x 28 mm
	71 mm x 43 mm	28 mm x 20 mm
01-2390-01	X	
01-2390-02		X
01-2390-03	X	X



1:2

RICHARDSON

240 mm – 9½ "
52 mm x 22 mm
01-2391



1:2

KELLY

260 mm – 10¼ "
65 mm x 50 mm
01-2392

Retractors



1:2

HOESEL
260 mm – 10 ¼"

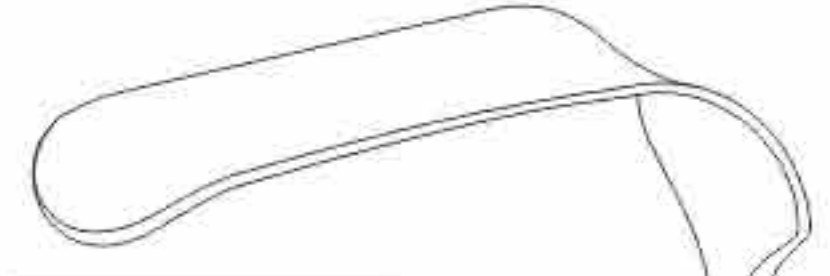

1:1

63 mm x 21 mm
01-2393-01

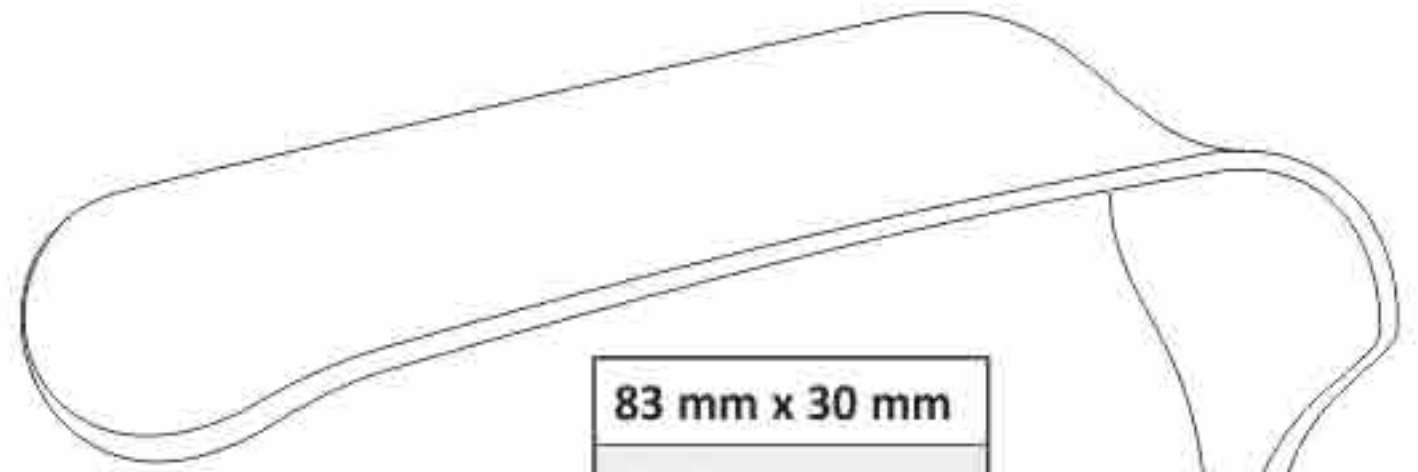

1:1

83 mm x 30 mm
01-2393-02

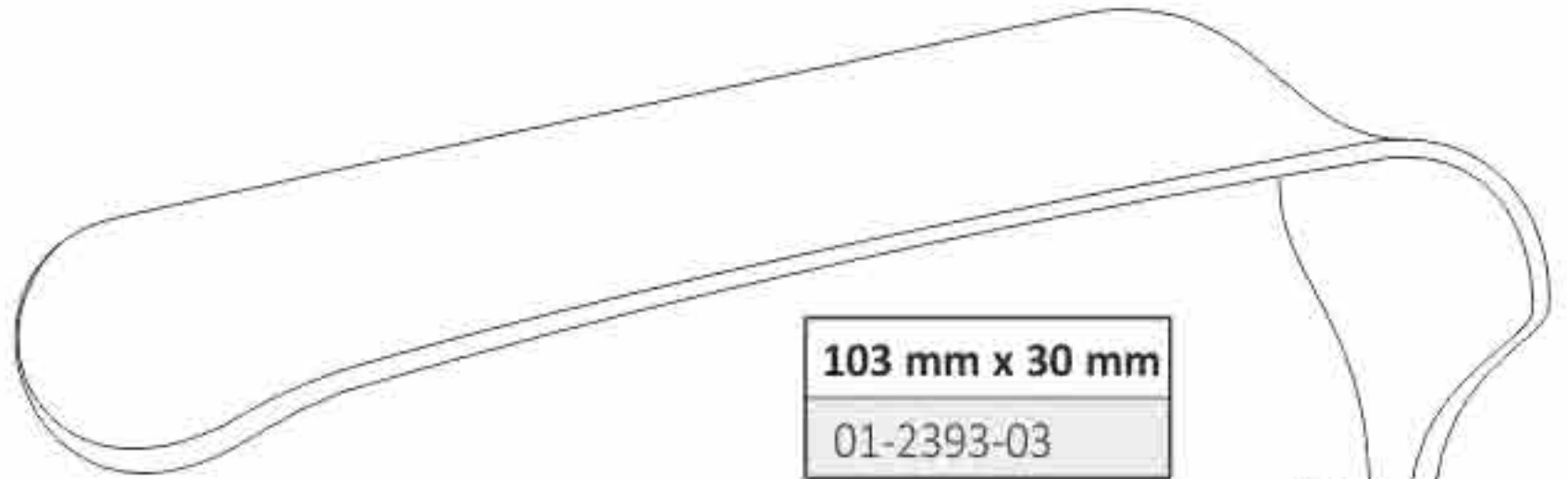

1:1

103 mm x 30 mm
01-2393-03

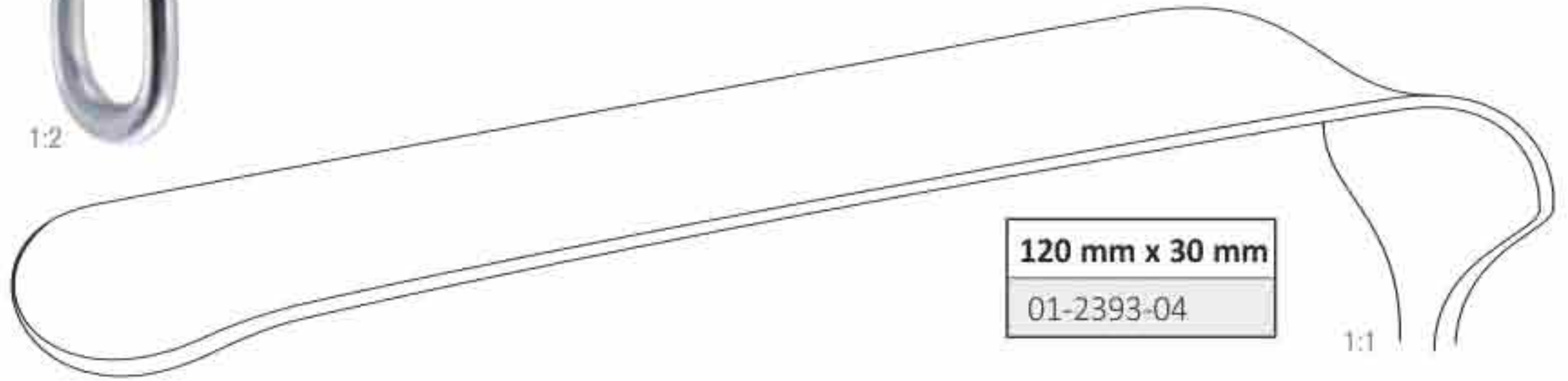

1:1

120 mm x 30 mm
01-2393-04

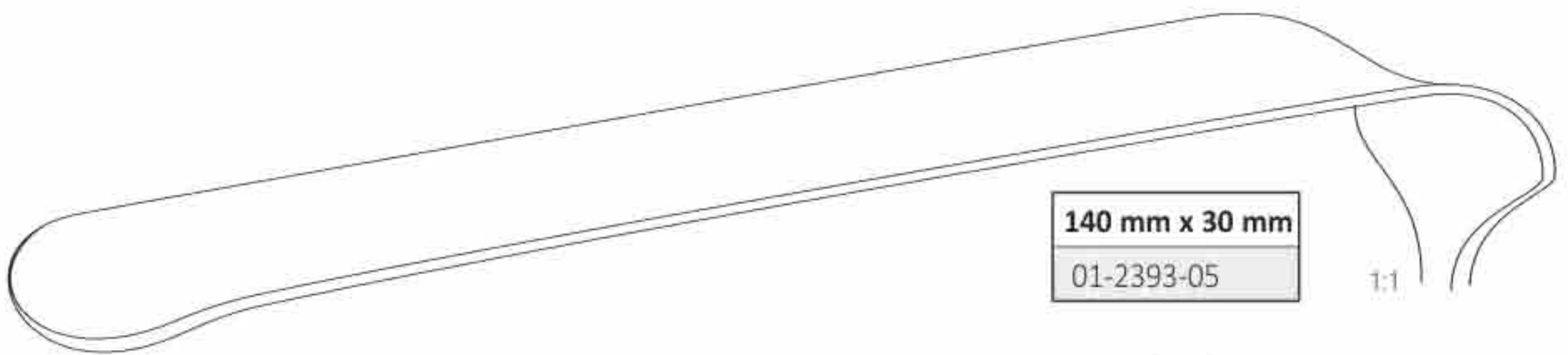

1:1

140 mm x 30 mm
01-2393-05

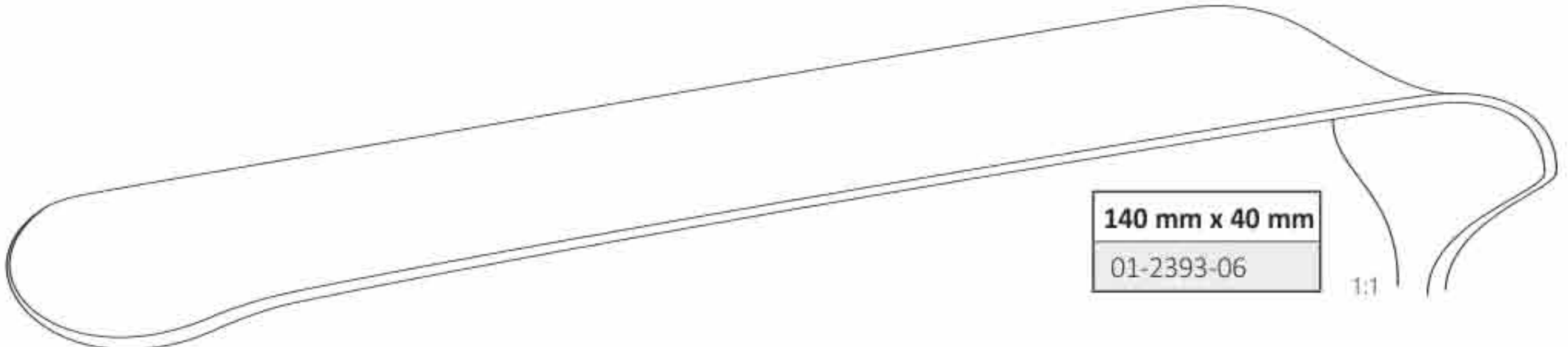

1:1

140 mm x 40 mm
01-2393-06

Retractors



MEYERDING

200 mm – 8"	220 mm – 8 ¼"
50 mm x 16 mm	75 mm x 25 mm
01-2394-01	01-2394-02

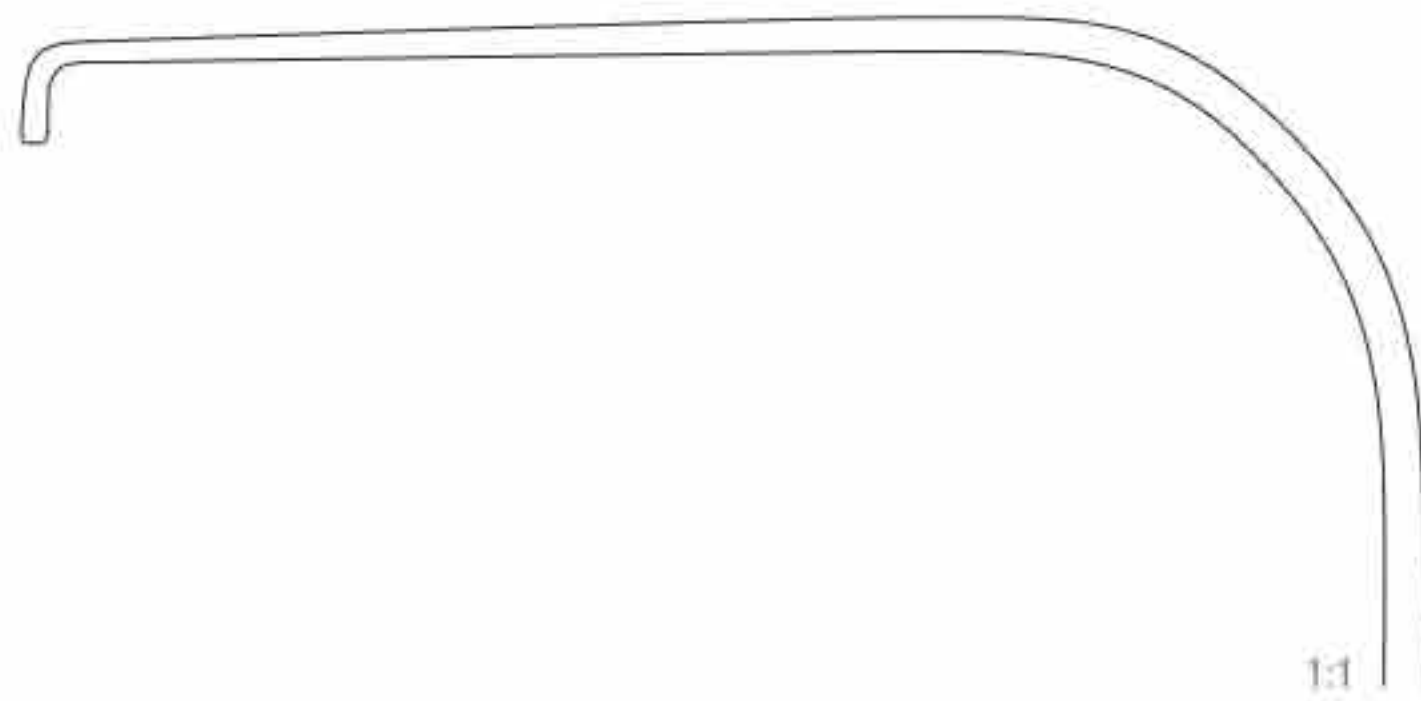
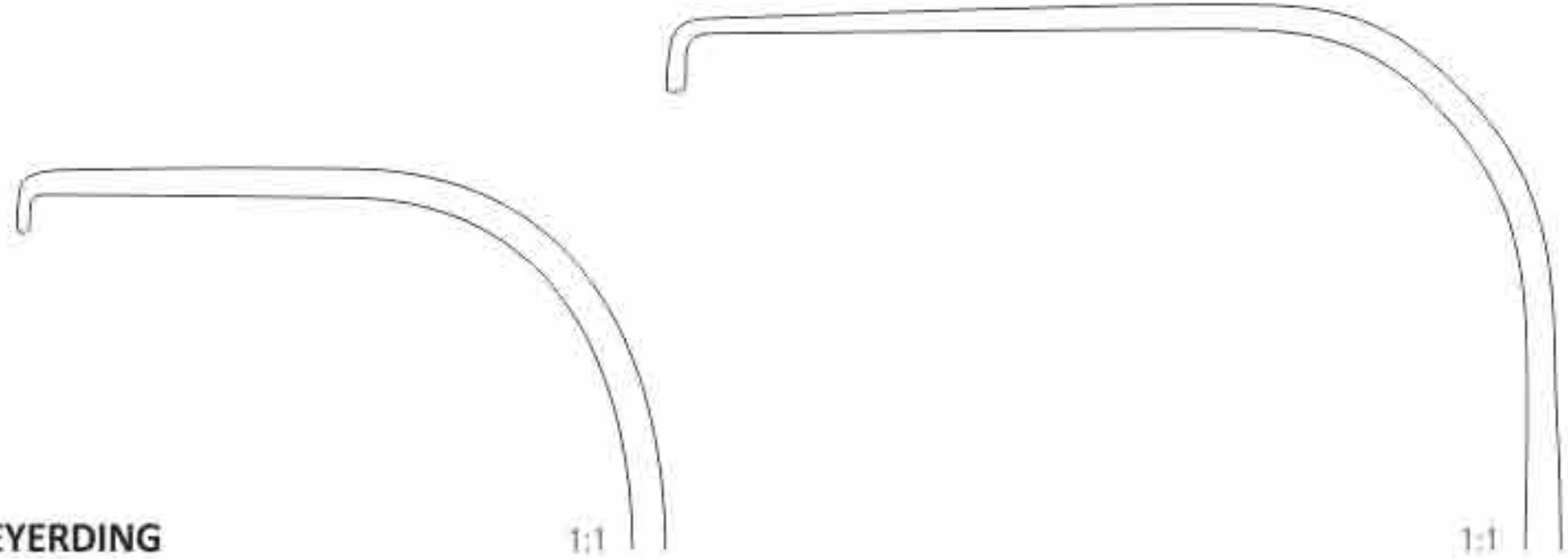

240 mm – 9 ½"
90 mm x 50 mm
01-2394-03

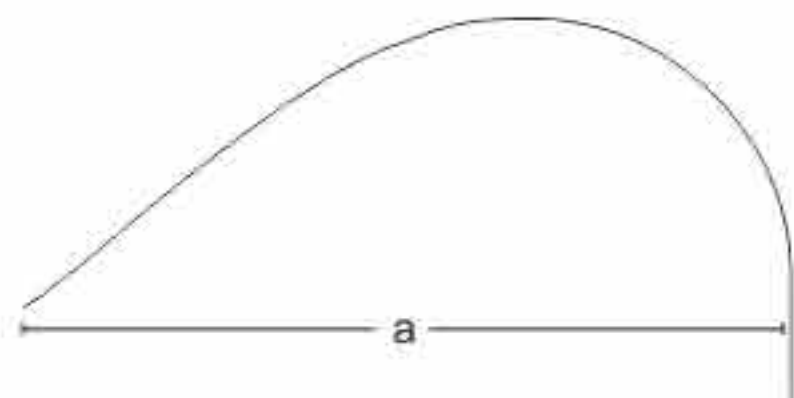

FRITSCH

240 mm – 9 ½"	a = 32 mm – b = 40 mm	01-2395-01
240 mm – 9 ½"	a = 45 mm – b = 40 mm	01-2395-02
240 mm – 9 ½"	a = 45 mm – b = 50 mm	01-2395-03
240 mm – 9 ½"	a = 45 mm – b = 60 mm	01-2395-04
240 mm – 9 ½"	a = 45 mm – b = 75 mm	01-2395-05
240 mm – 9 ½"	a = 65 mm – b = 85 mm	01-2395-06

Retractors

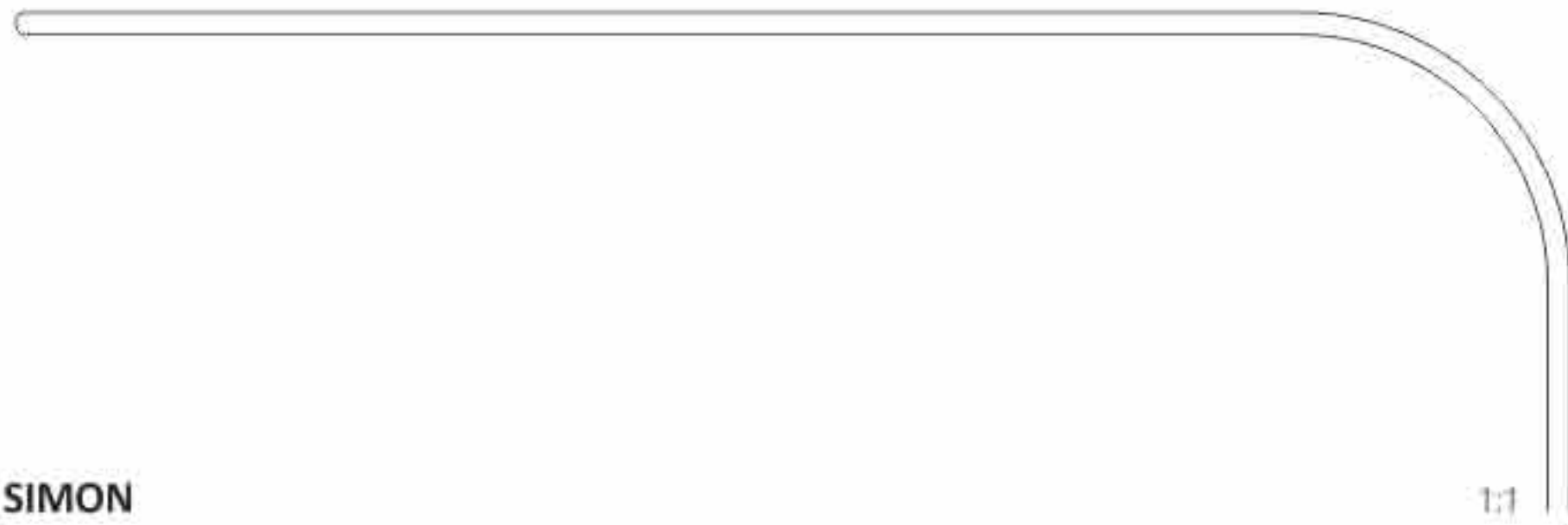

SIMON

	115 mm x 22 mm	115 mm x 27 mm
280 cm – 11 "	01-2396-01	01-2396-02

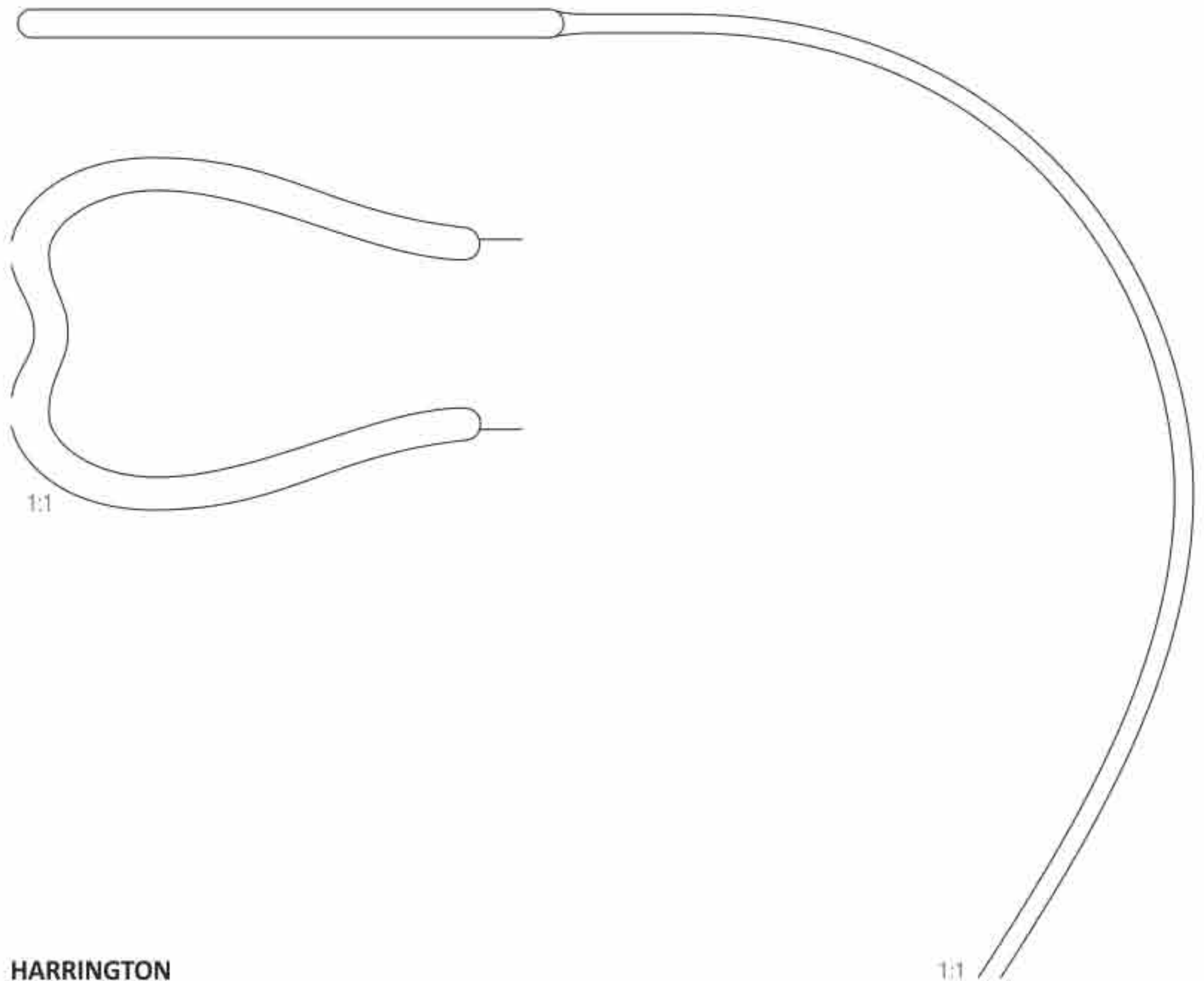

HARRINGTON

	127 mm x 40 mm	127 mm x 62 mm
320 mm – 12 ½ "	01-2397-01	01-2397-02

Retractors



1:2

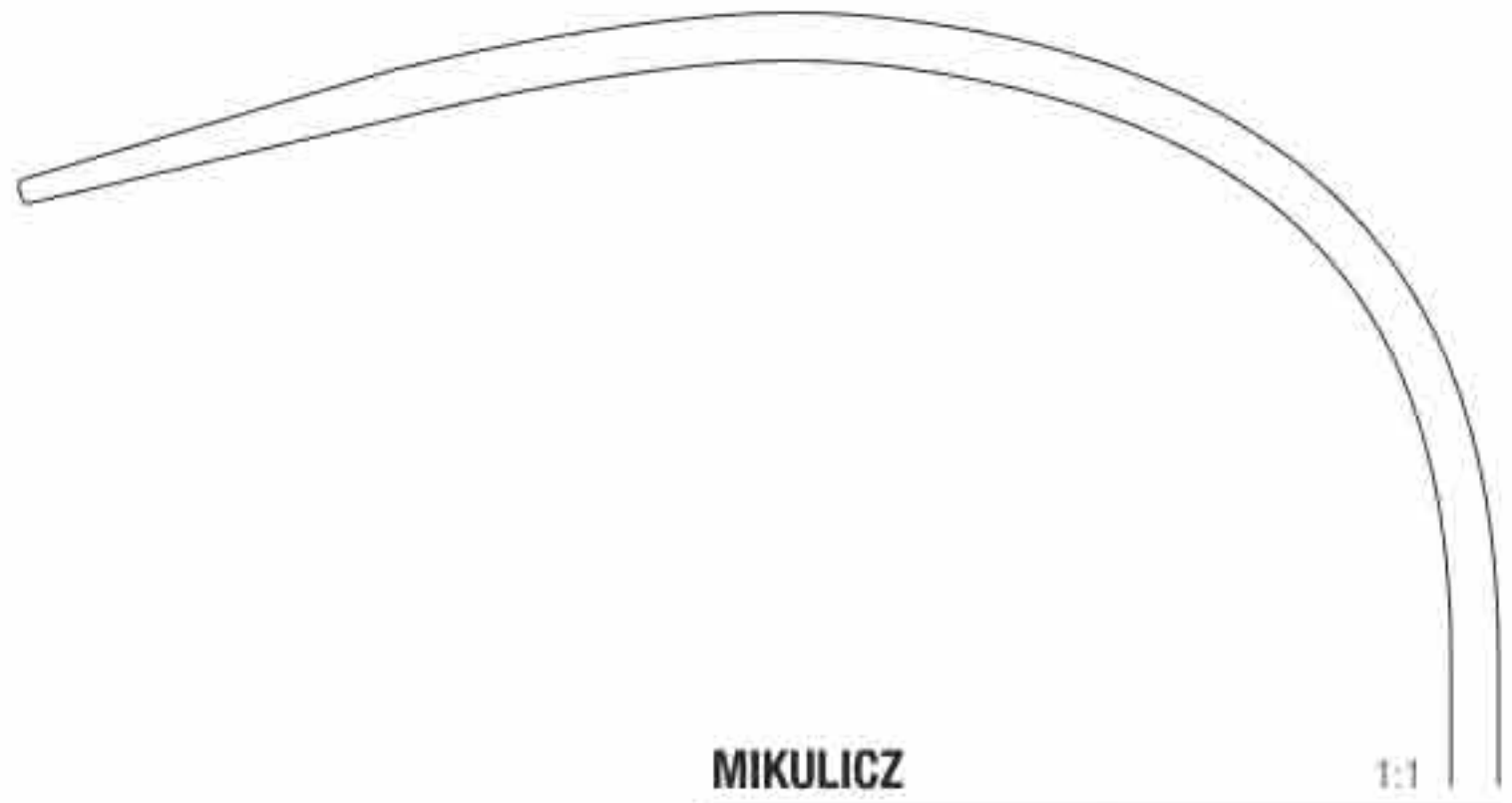

1:1

MIKULICZ

	95 mm x 35 mm
260 mm – 10 ¼"	01-2398-01

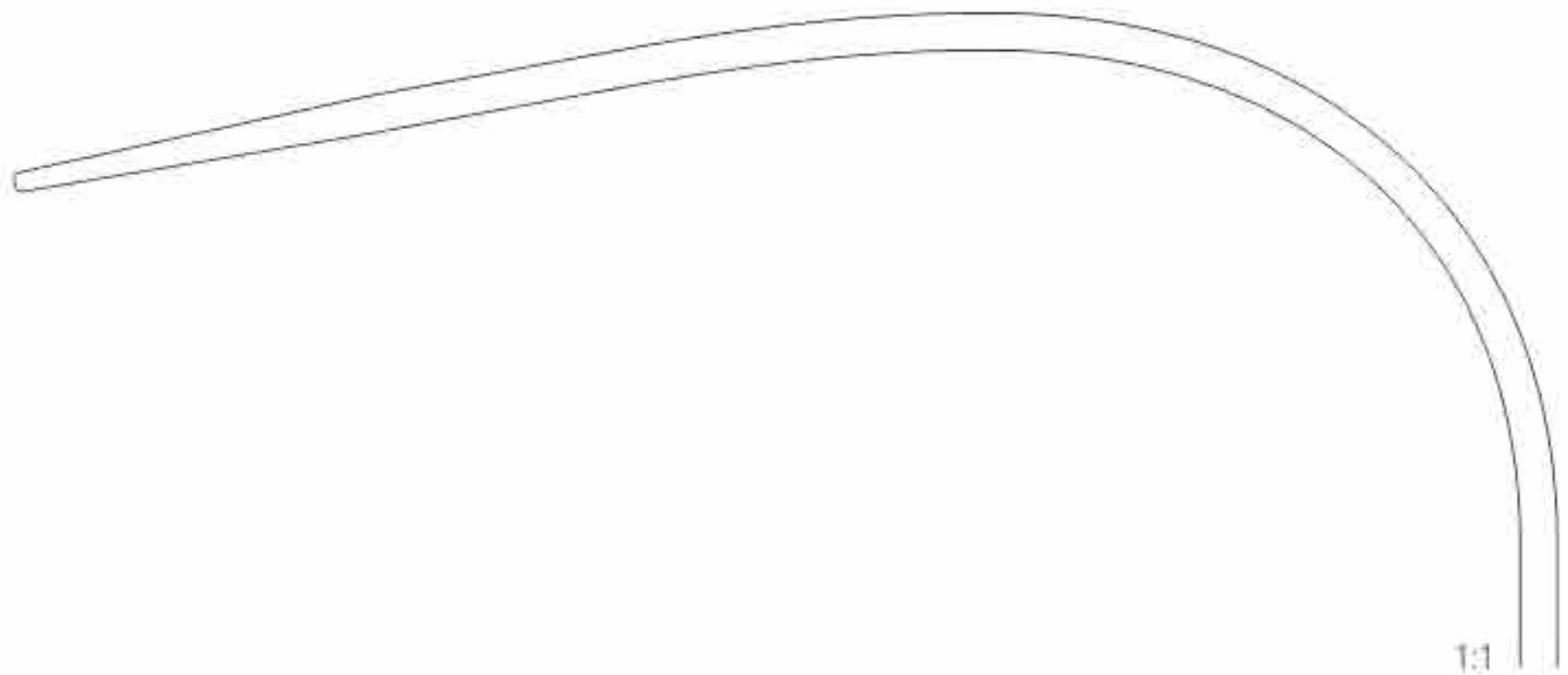

1:1

120 mm x 50 mm
01-2398-02

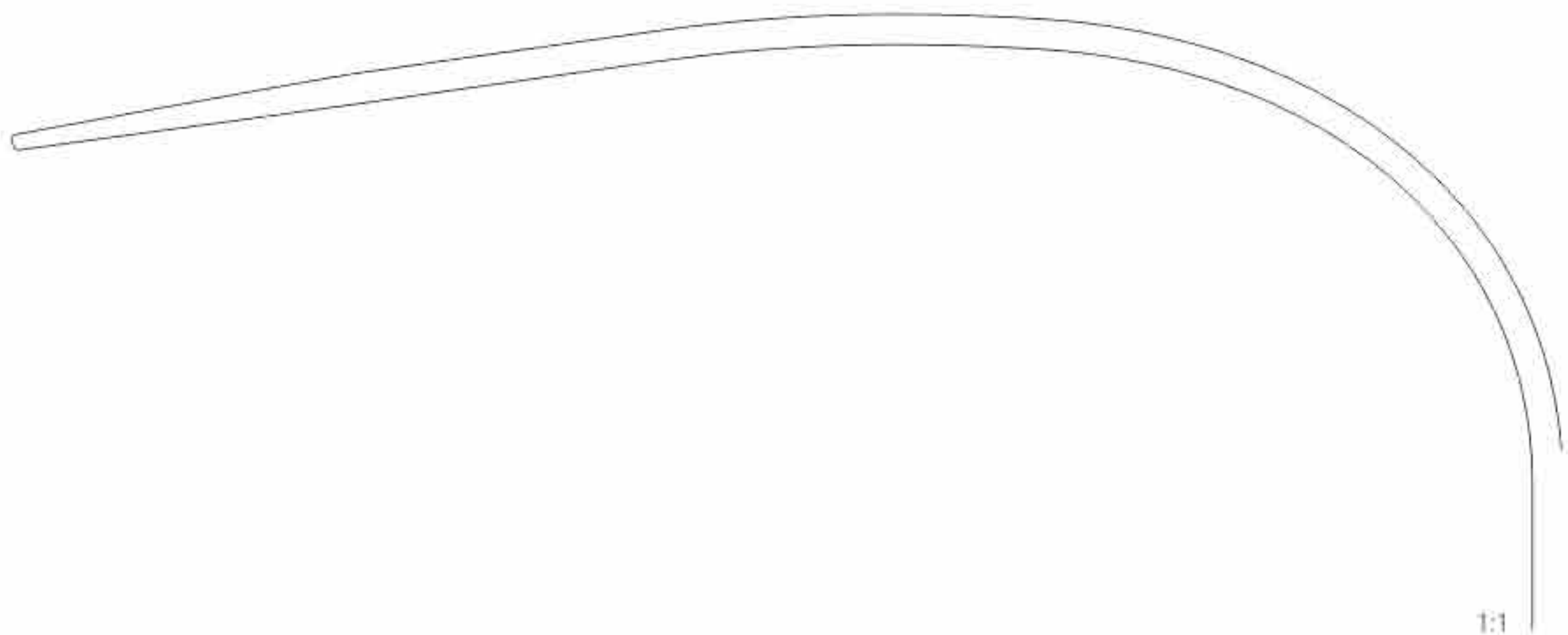

1:1

150 mm x 50 mm	180 mm x 50 mm
01-2398-03	01-2398-04

Retractors



MIKULICZ

1:2

260 mm – 10 ¼ "	90 mm x 50 mm	01-2399
-----------------	---------------	---------



DAVIDSON

1:2

	a = 75 mm – b = 50 mm	a = 75 mm – b = 90 mm
160 mm – 6 ¼ "	01-2400-01	01-2400-02

Retractors

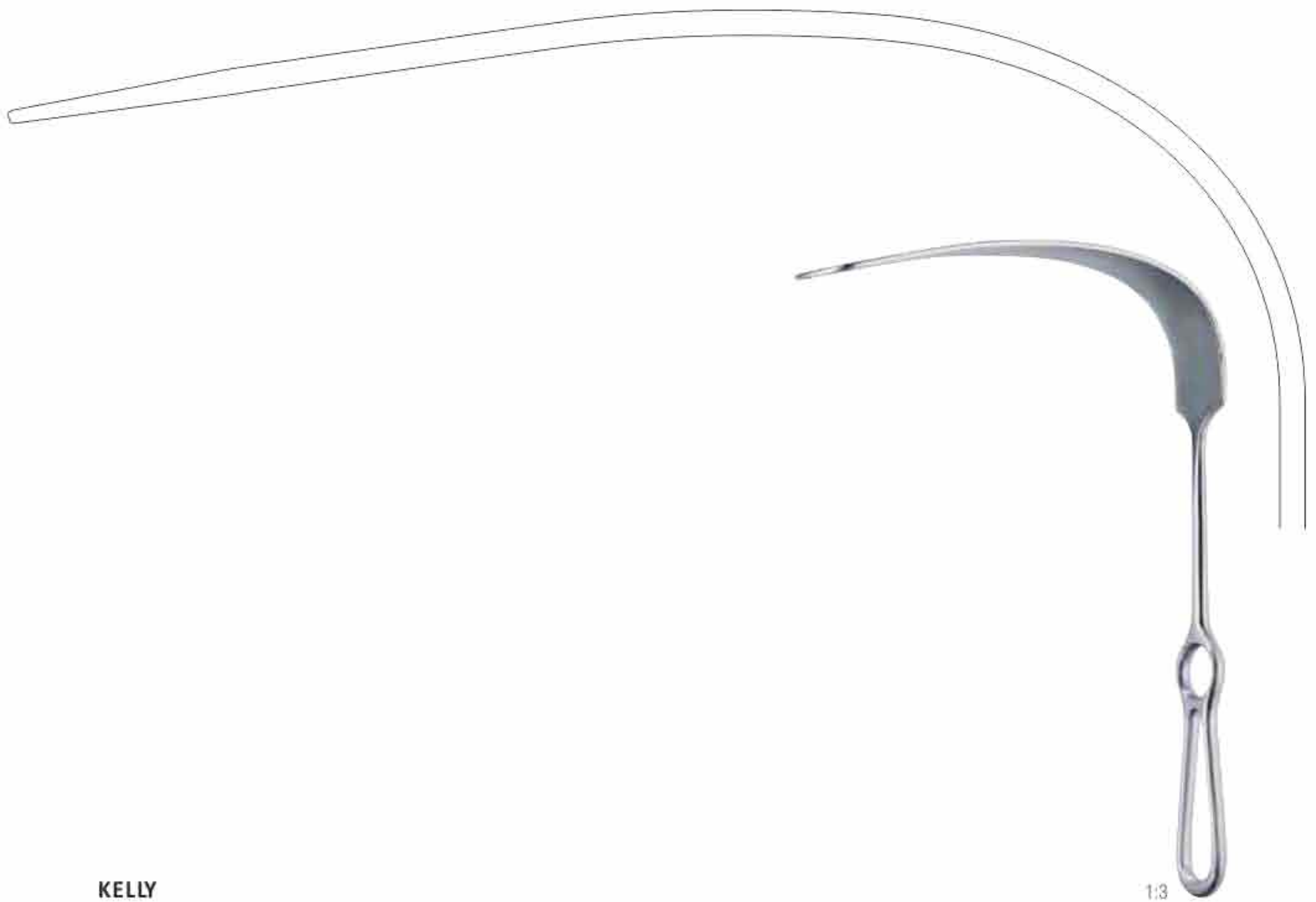

KELLY

	160 mm x 38 mm	190 mm x 38 mm	160 mm x 57 mm	190 mm x 57 mm
270 mm – 10 3/4 "	01-2401-01	01-2401-02	01-2401-03	01-2401-04

Retractors

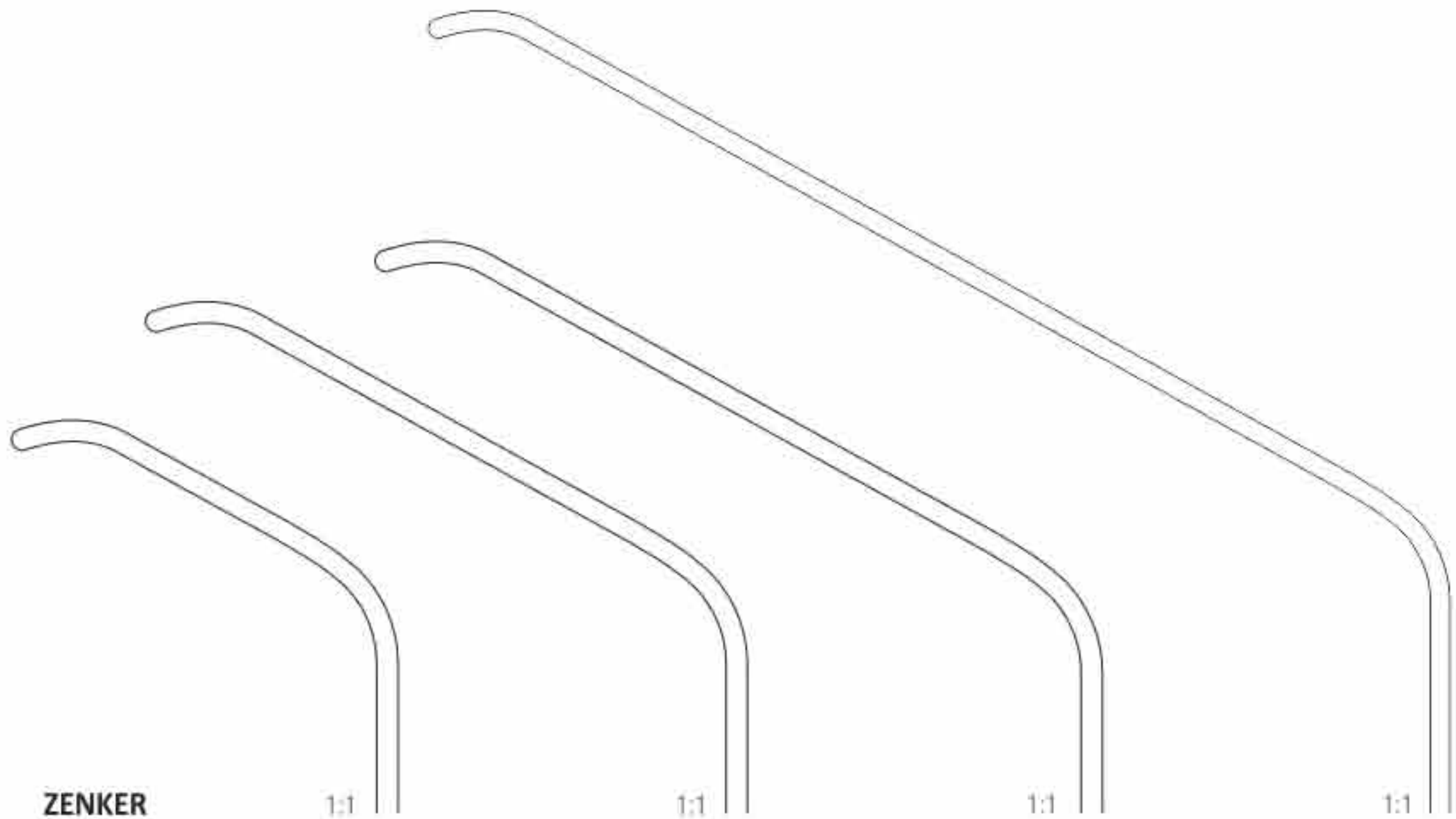

ZENKER

250 mm – 9 ¾ "	260 mm – 10 ¼ "	275 mm – 10 ¾ "	290 mm – 11 ½ "
35 mm x 8 mm	60 mm x 12 mm	75 mm x 12 mm	120 mm x 12 mm
01-2402-01	01-2402-02	01-2402-03	01-2402-04

Retractors



COOLEY 1:2



1:2



1:2

250 mm – 9 ¾ "	250 mm – 9 ¾ "	270 mm – 10 ½ "
01-2403-01	01-2403-02	01-2403-03

right

right, serrated

left

Retractors

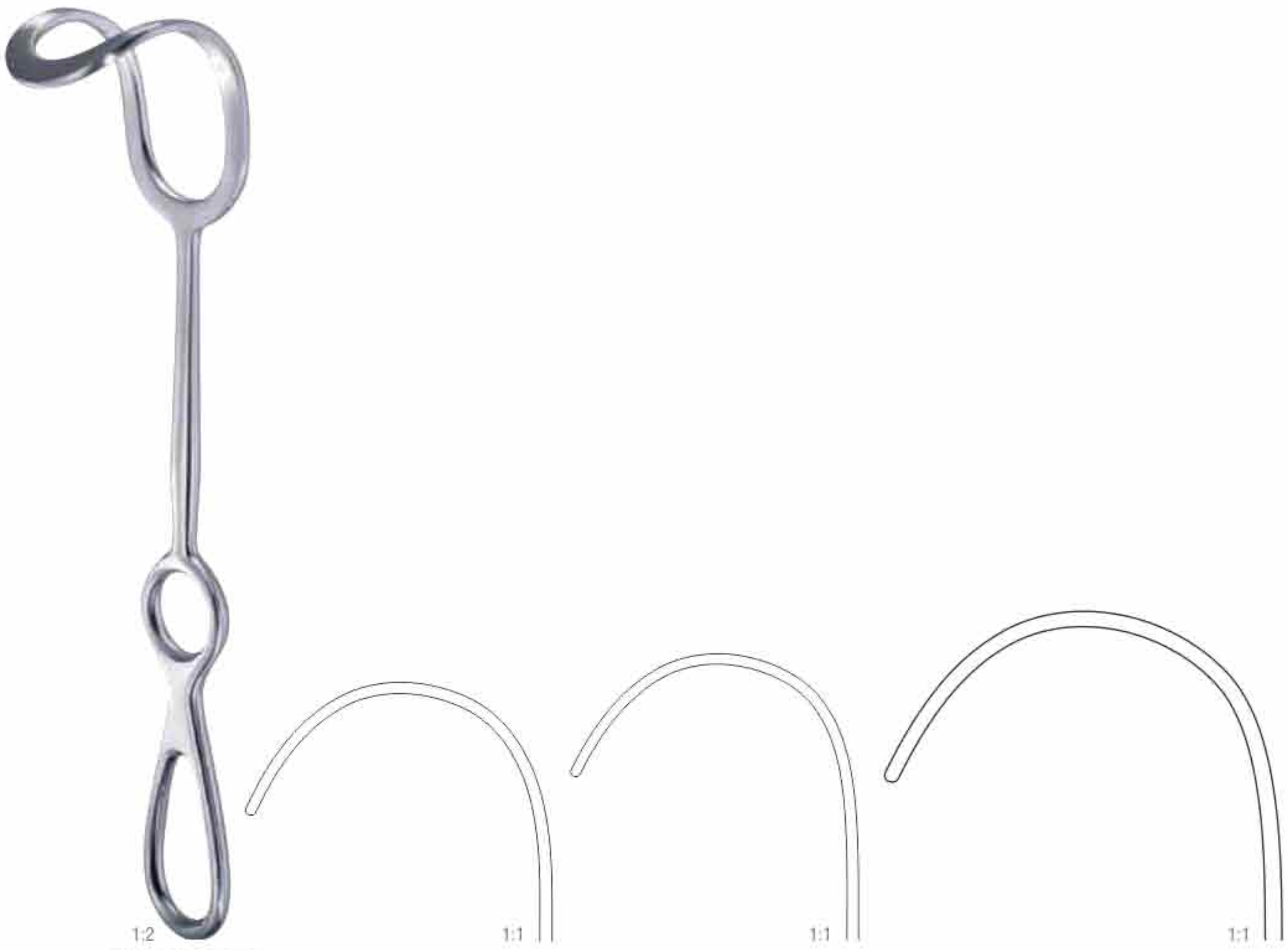

1:2
MIDDELDORPF

	45 mm x 45 mm	45 mm x 50 mm	55 mm x 70 mm
255 mm – 10"	01-2404-01	01-2404-02	01-2404-03

Retractors

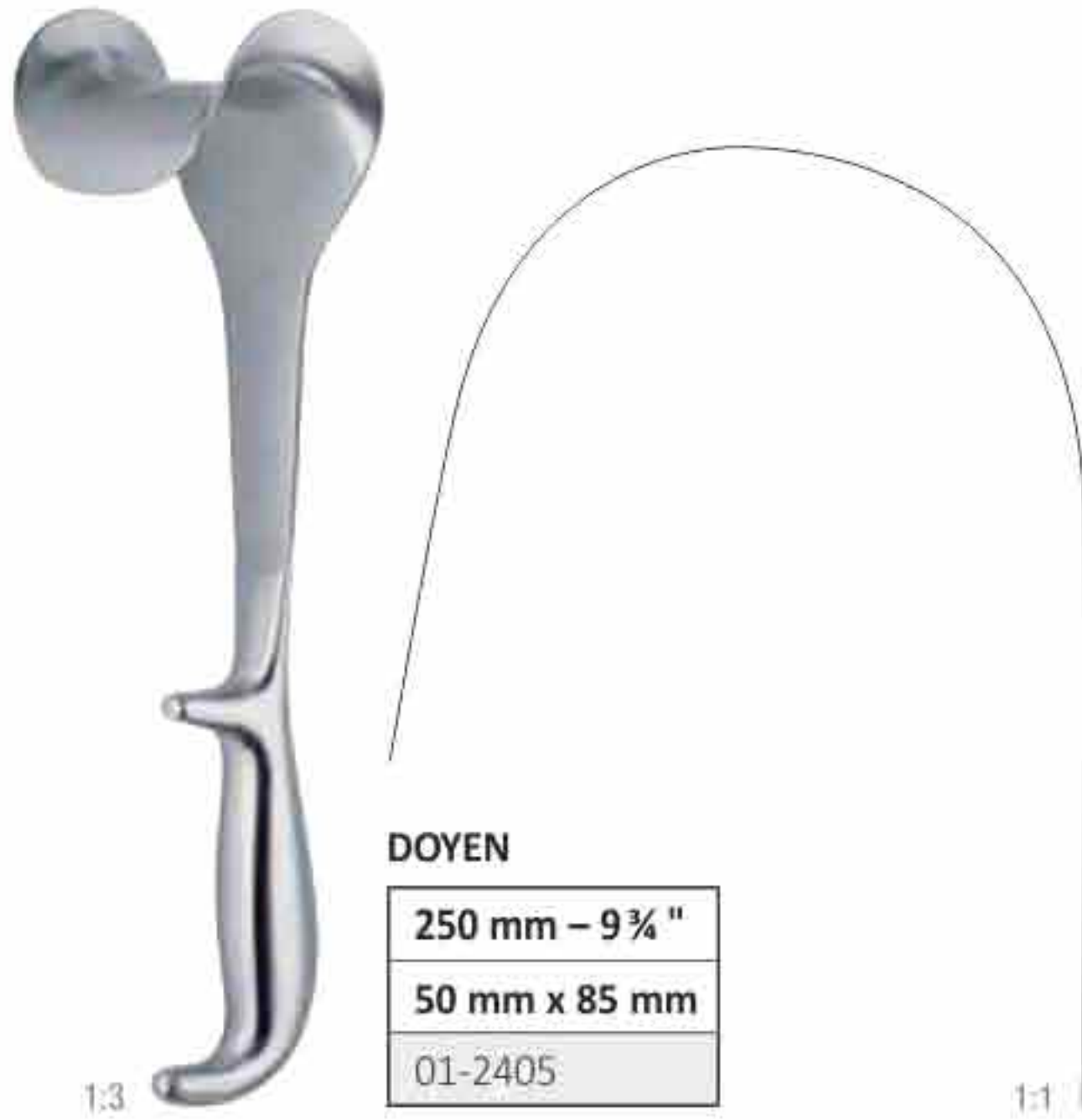

DOYEN

250 mm – 9 ¾ "
50 mm x 85 mm
01-2405



TUFFIER

230 mm – 9 "
64 mm x 60 mm
01-2406



KOCHER

225 mm – 8 ¾ "
70 mm x 25 mm
01-2407



KOCHER

	250 mm – 9 ¾ "
80 mm x 45 mm	01-2408-01
80 mm x 55 mm	01-2408-02
80 mm x 65 mm	01-2408-03

Retractors

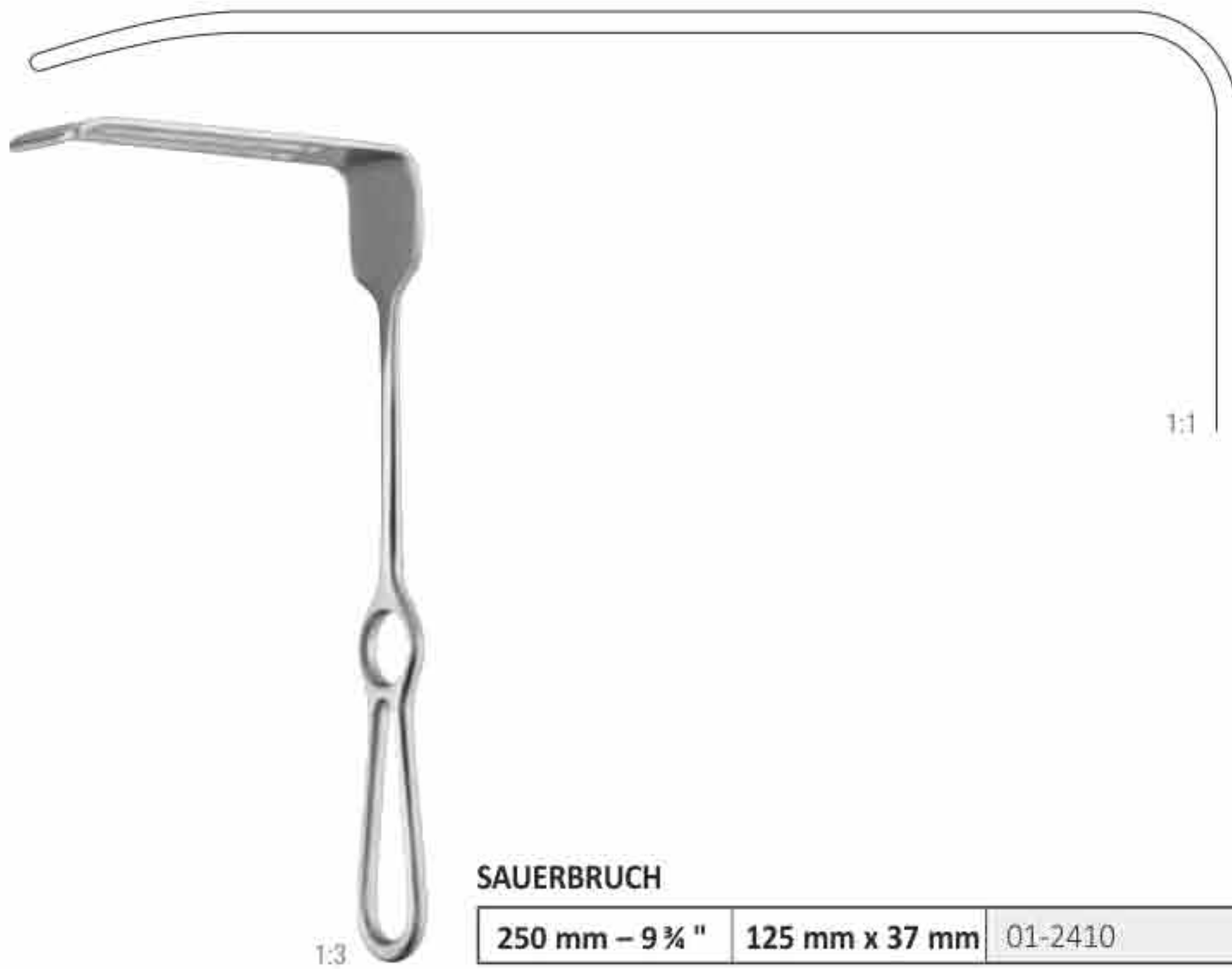
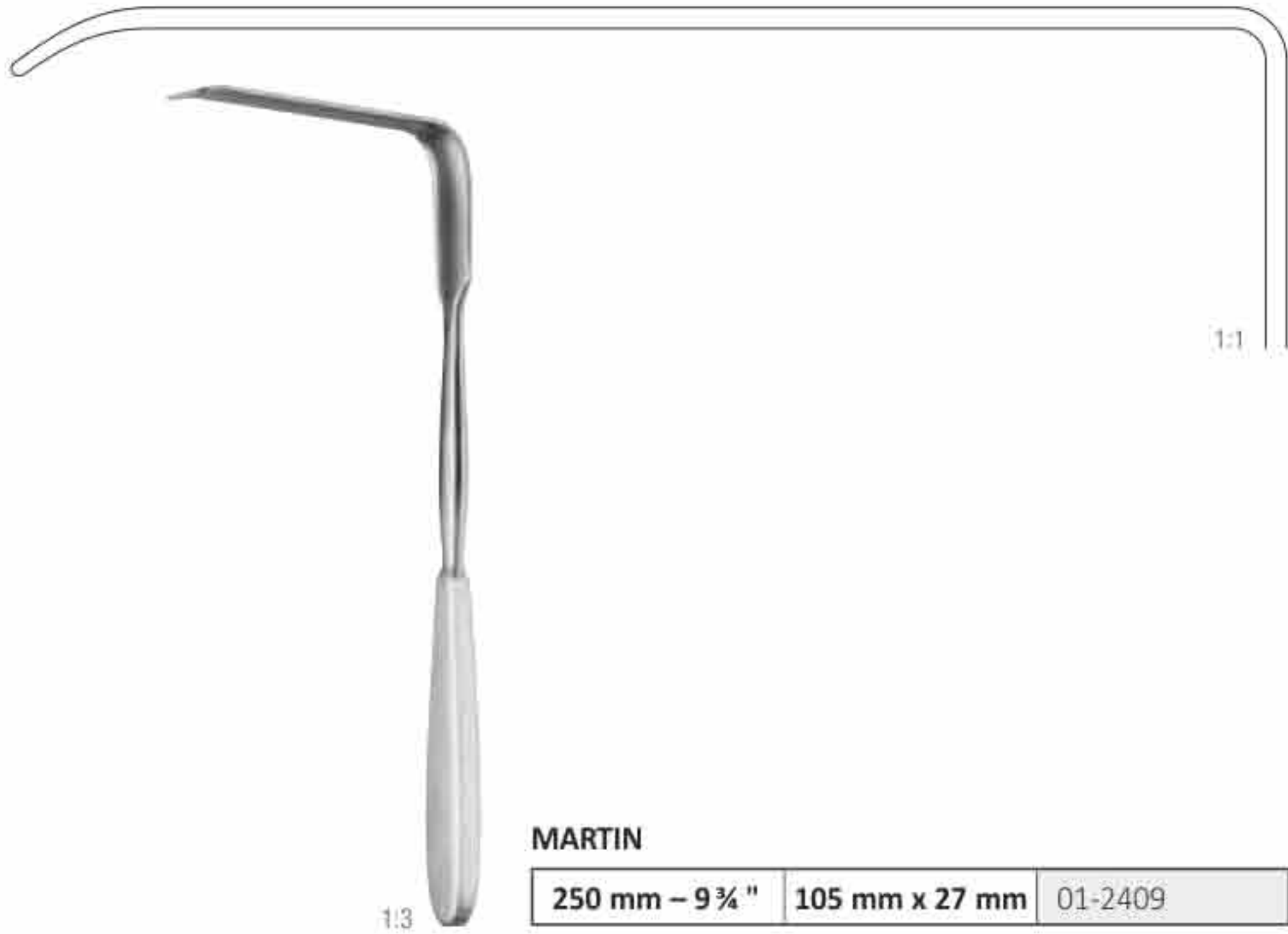

Retractors

HEANEY



1:1

	45 mm x 25 mm	73 mm x 28 mm
270 mm – 10 3/4 "	01-2411-01	01-2411-02



1:1



1:1

82 mm x 28 mm
01-2411-03

1:2

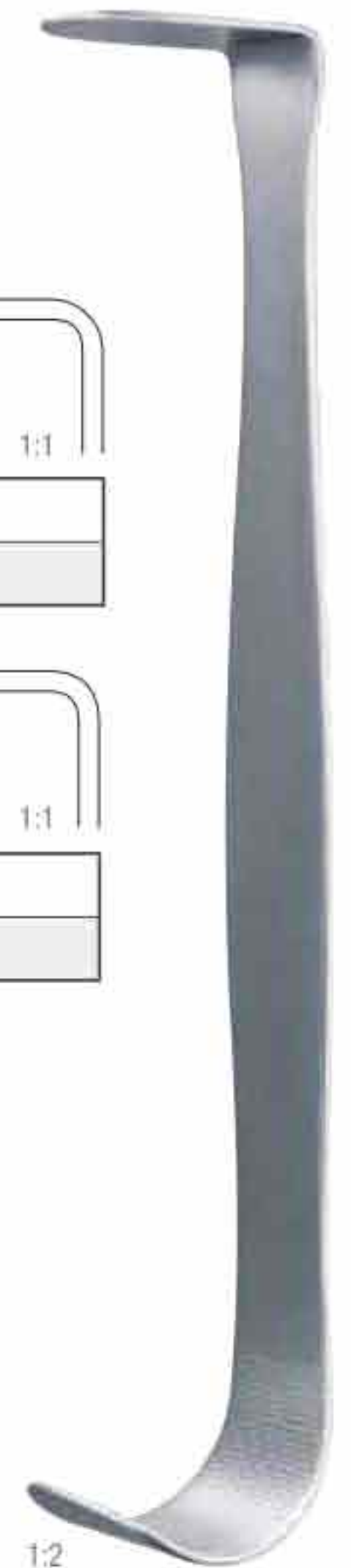

CORYLLOS

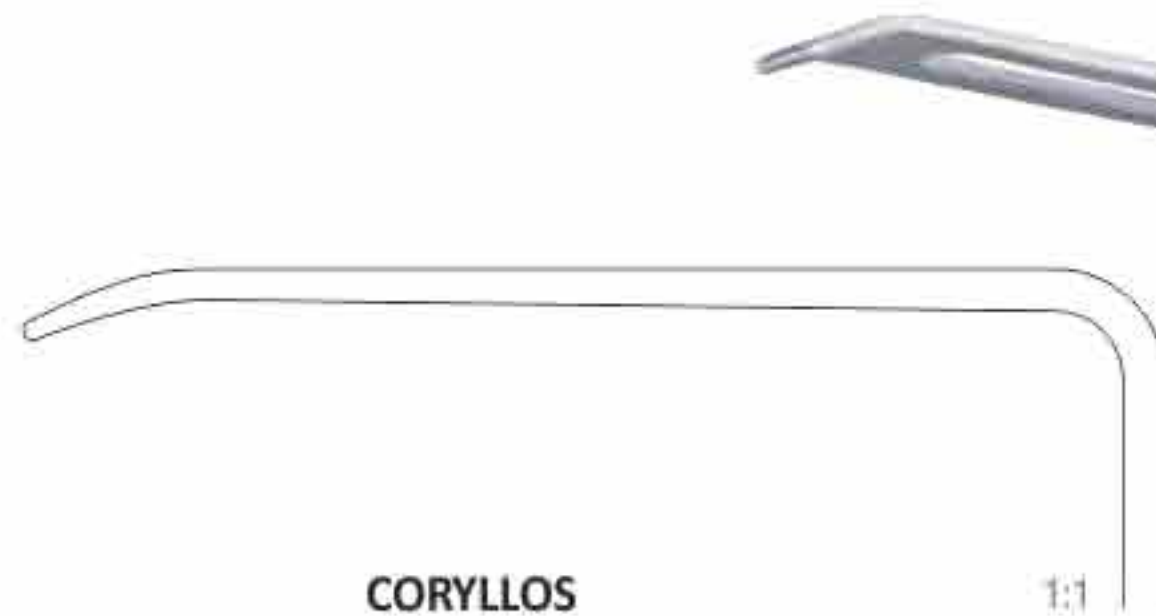

1:1

	82 mm x 22 mm
240 mm – 9 1/2 "	01-2412-01



1:1

108 mm x 43 mm
01-2412-02



1:1

115 mm x 65 mm
01-2412-03

1:2



Retractors



1:2

BRUNNER

250 mm – 9 3/4"

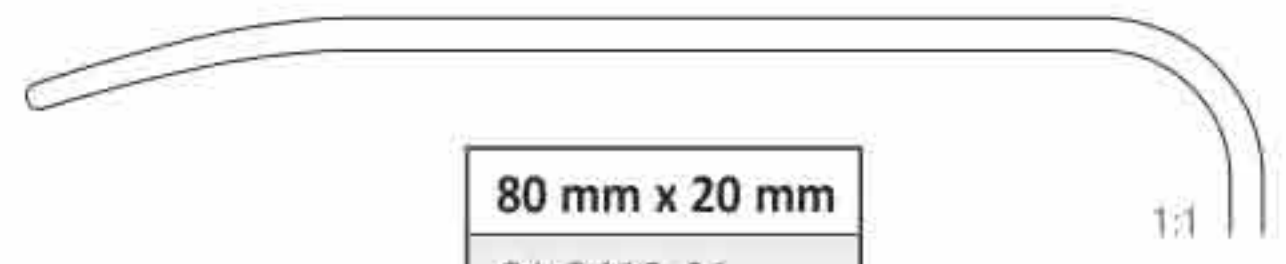

80 mm x 20 mm

01-2413-01

1:1



100 mm x 20 mm

01-2413-02

1:1



120 mm x 25 mm

01-2413-03

1:1



140 mm x 25 mm

01-2413-04

1:1



160 mm x 25 mm

01-2413-05

1:1



180 mm x 30mm

01-2413-06

1:1

Retractors



BRUNNER

1:2

240 mm – 9 ½ "	142 mm x 25 mm	01-2414
----------------	----------------	---------

Retractors



GIL-VERNET

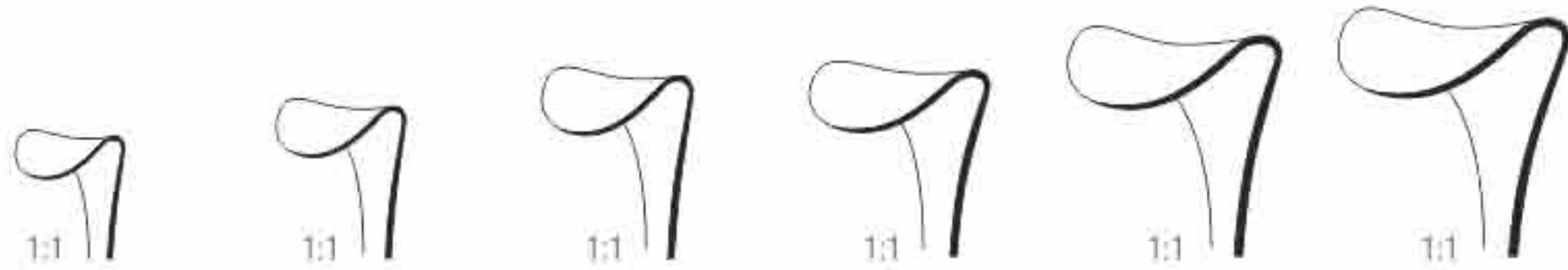

	x = 8 mm	x = 11 mm	x = 15 mm	x = 17 mm	x = 20 mm	x = 23 mm
240 mm – 9 ½"	01-2415-01	01-2415-02	01-2415-03	01-2415-04	01-2415-05	01-2415-06

malleable



ST. MARKS

290 mm – 11 ½"	325 mm – 12 ¾"	330 mm – 13"
130 mm x 60 mm	180 mm x 60 mm	180 mm x 60 mm
01-2416-01	01-2416-02	01-2416-03

Retractors

CUSHING

200 mm – 8"
01-2417



1:2

KOERTE

280 mm – 11"
120 mm x 47 mm
01-2418



1:2



MORRIS 1:2

210 mm – 8 ¼"
50 mm x 55 mm
01-2419



1:2

MORRIS

	38 mm x 51 mm	50 mm x 55 mm	64 mm x 51 mm
245 mm – 9 ¾"	01-2420-01	01-2420-02	01-2420-03

Retractors



Deaver

	x = 25 mm	x = 38 mm	x = 50 mm
315 mm – 12½"	01-2421-01	01-2421-02	01-2421-03

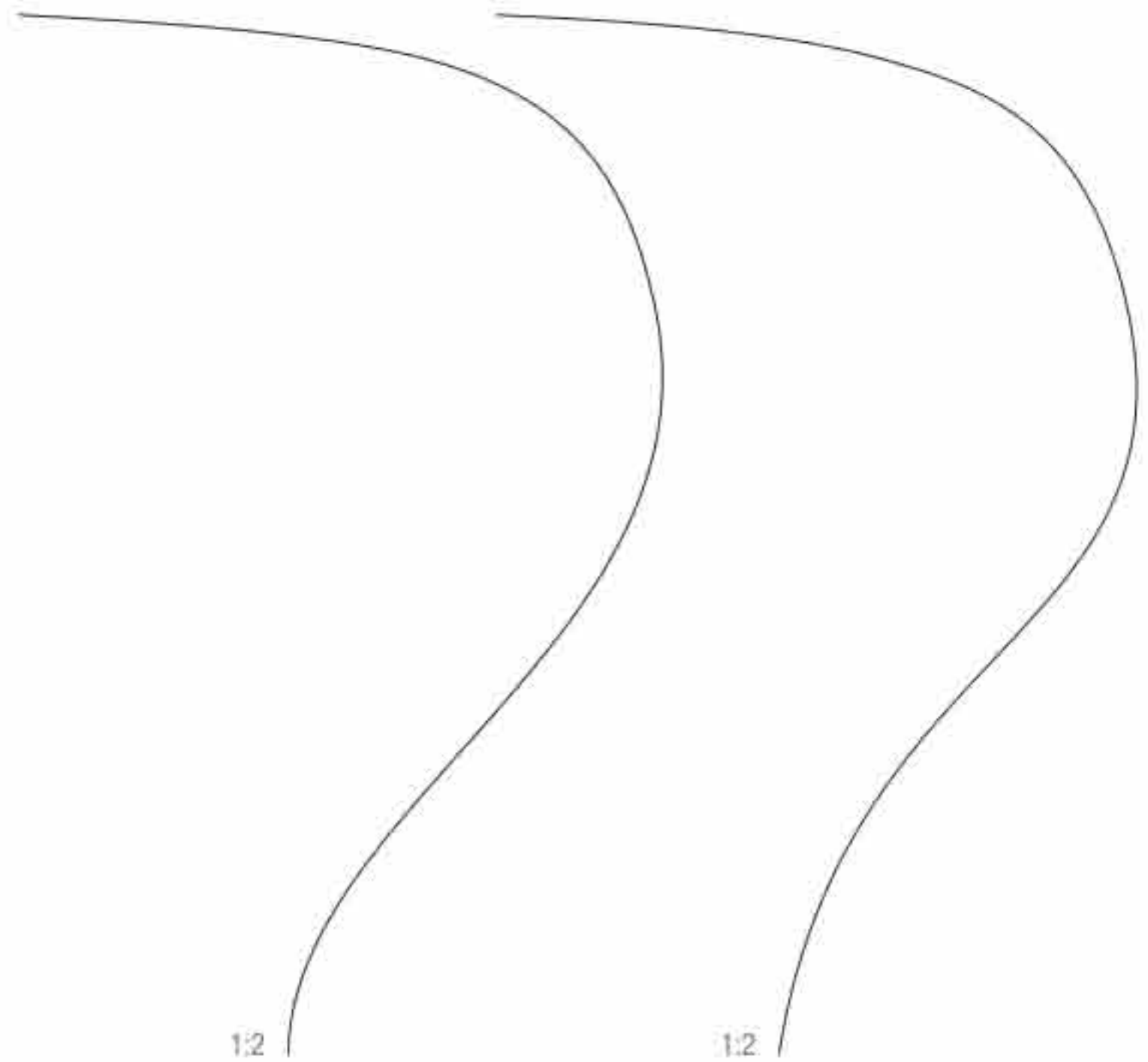
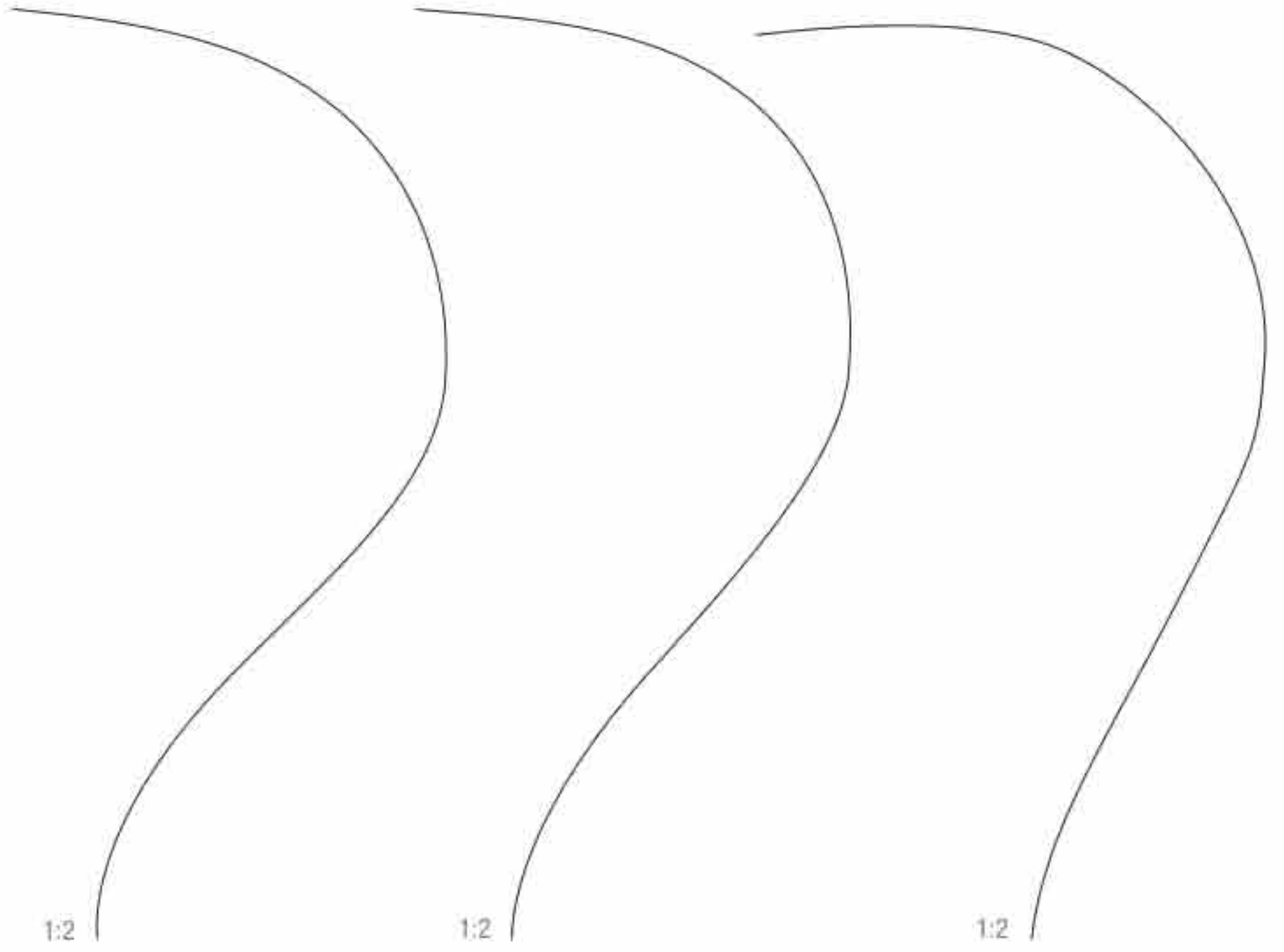

x = 75 mm	x = 100 mm
01-2421-04	01-2421-05

Retractors



Retractors



DEAVER 1:2

1:2

1:2

300 mm – 12"	330 mm – 13"	360 mm – 14 ¼"
x = 25 mm	x = 25 mm	x = 25 mm
01-2423-01	01-2423-02	01-2423-03

Retractors



DEAVER 1:2	1:2	1:2
300 mm – 12"	300 mm – 12"	300 mm – 12"
x = 38 mm	x = 50 mm	x = 75 mm
01-2423-04	01-2423-05	01-2423-06

Retractors

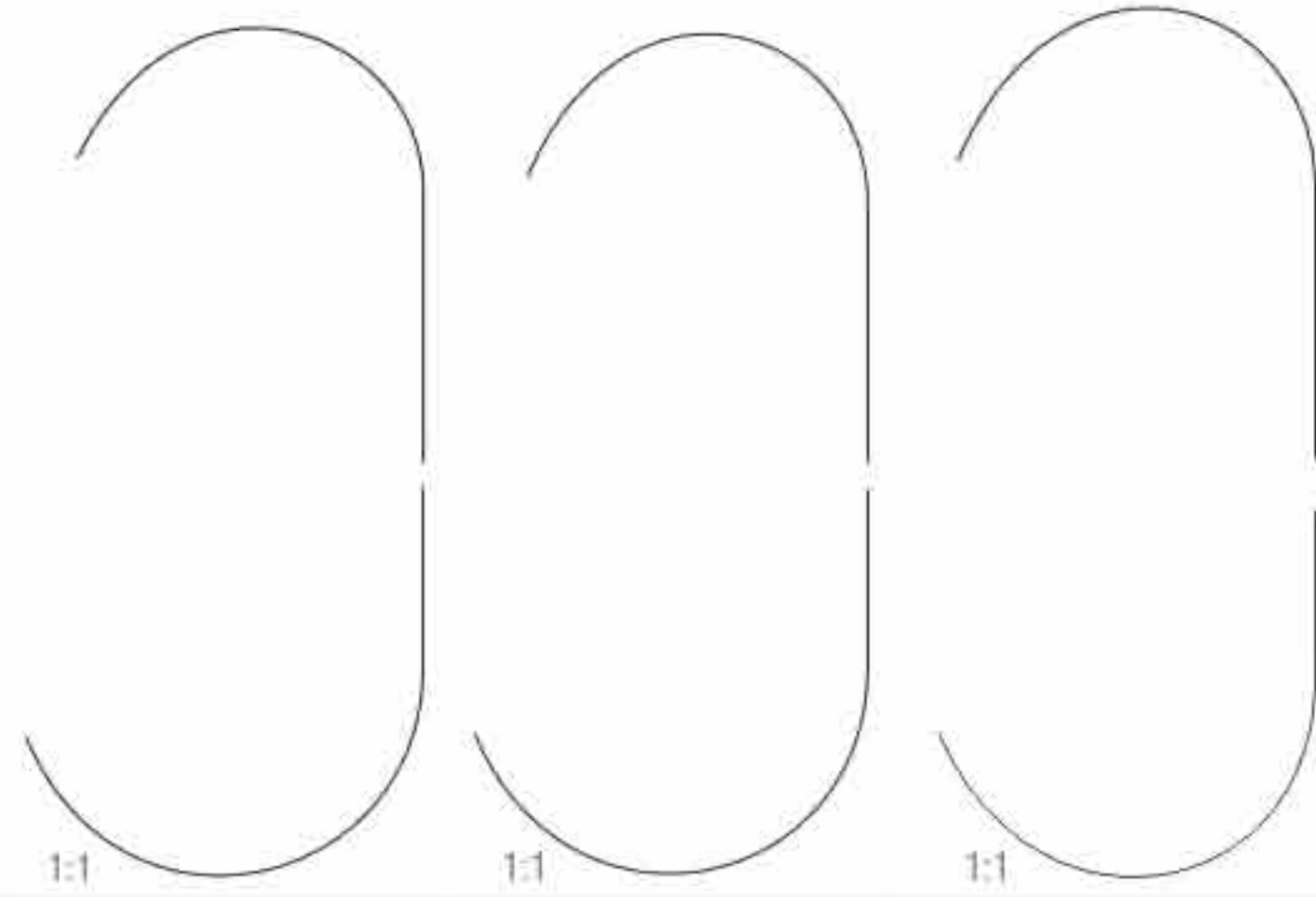

ROUX

	Fig. 1	Fig. 2	Fig. 3
	140 mm – 5 ½ "	150 mm – 6 "	170 mm – 6 ¾ "
	24 mm x 20 mm	29 mm x 26 mm	33 mm x 29 mm
	30 mm x 28 mm	36 mm x 36 mm	38 mm x 43 mm
	01-2424-01	01-2424-02	01-2424-03

01-2424-04	x	x	x
------------	----------	----------	----------

Set

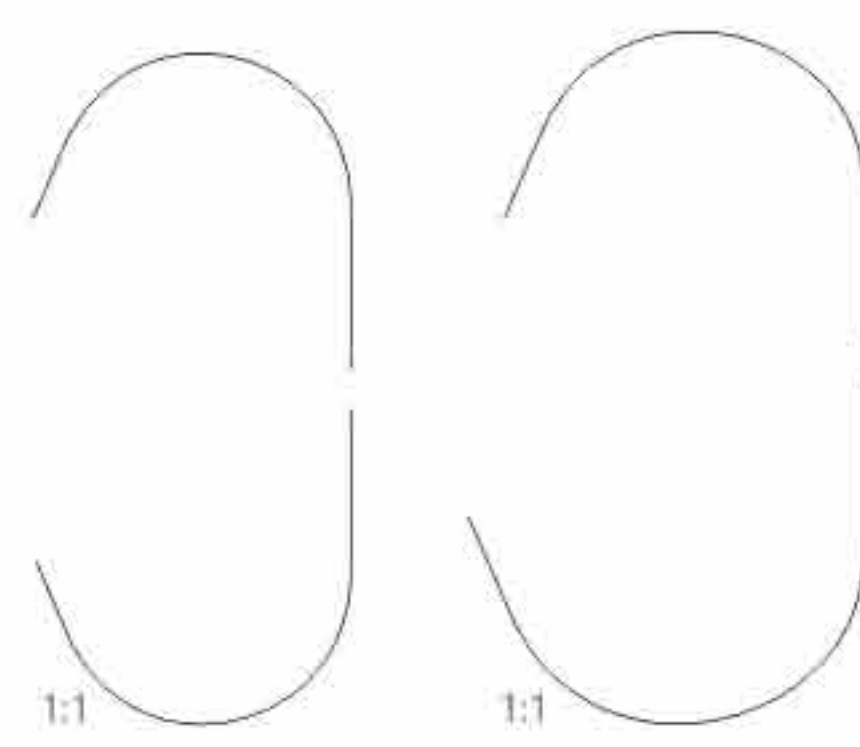

PARKER

	Fig. 1	Fig. 2
	135 mm – 5 ¼ "	135 mm – 5 ¼ "
	18 mm x 15 mm	22 mm x 15 mm

01-2425	x	x
---------	----------	----------

Set

Retractors

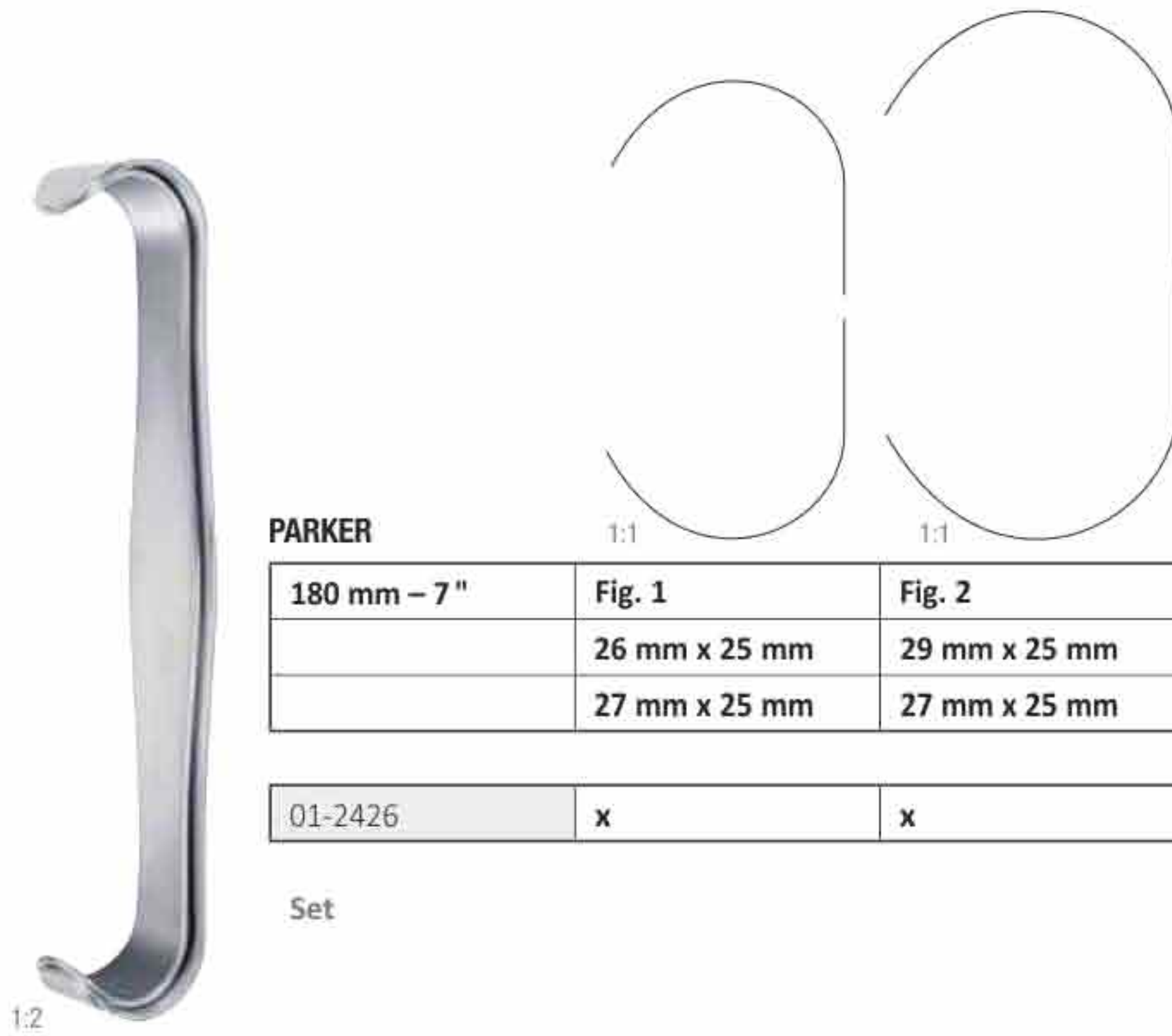

PARKER

180 mm – 7"	Fig. 1	Fig. 2
	26 mm x 25 mm	29 mm x 25 mm
	27 mm x 25 mm	27 mm x 25 mm

01-2426	x	x
---------	---	---

Set



MINI-ROUX

145 mm – 5 ¾"
8 mm x 6 mm
01-2427



BABY-ROUX

130 mm – 5"
17 mm x 16 mm
18 mm x 22 mm
01-2428

Retractors



1:2

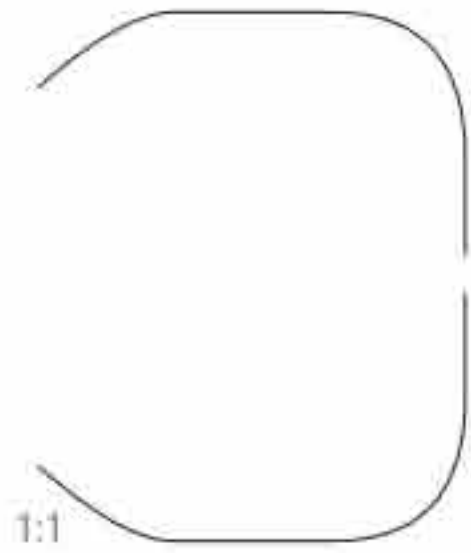

1:1

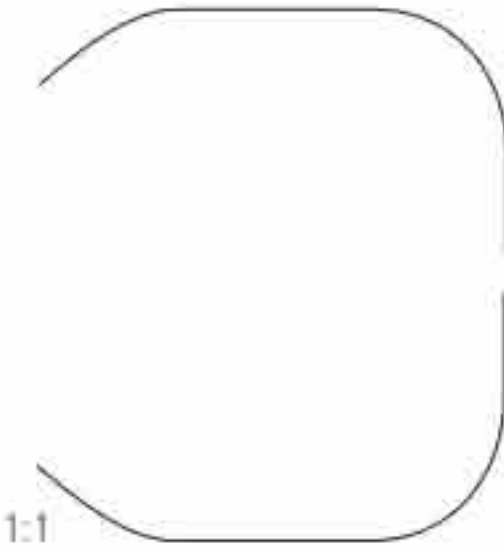

1:1

MAYO-COLLIN

150 mm – 6"	Fig. 1	Fig. 2
	25 mm x 18 mm	28 mm x 19 mm
	28 mm x 18 mm	32 mm x 19 mm

01-2429	x	x
---------	---	---

Set



1:2

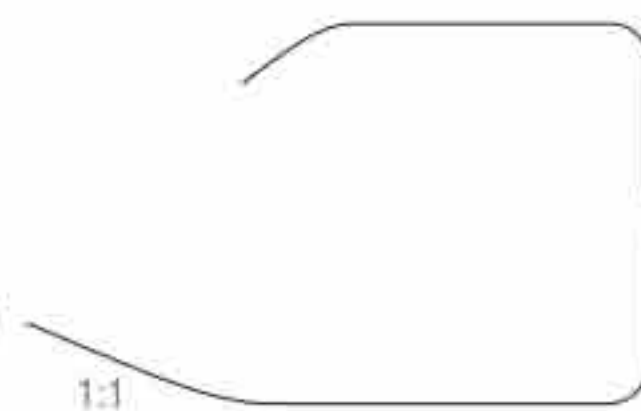

1:1

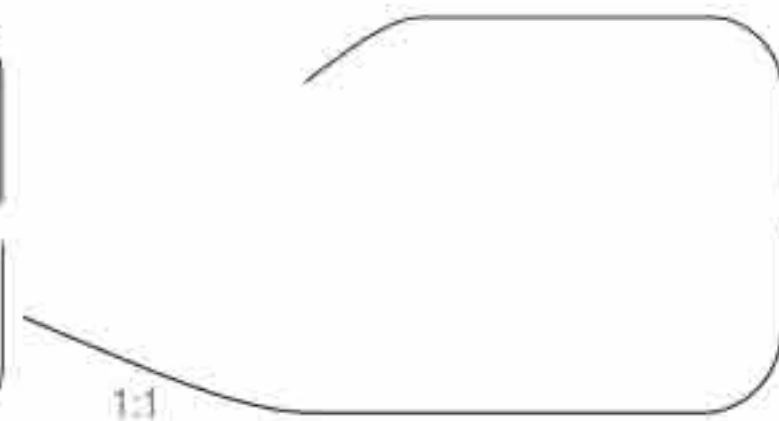

1:1

PARKER-LANGENBECK (US ARMY)

210 mm – 8 ¼"	Fig. 1	Fig. 2
	21 mm x 24 mm	25 mm x 24 mm
	40 mm x 15 mm	45 mm x 15 mm

01-2430	x	x
---------	---	---

Set

Retractors

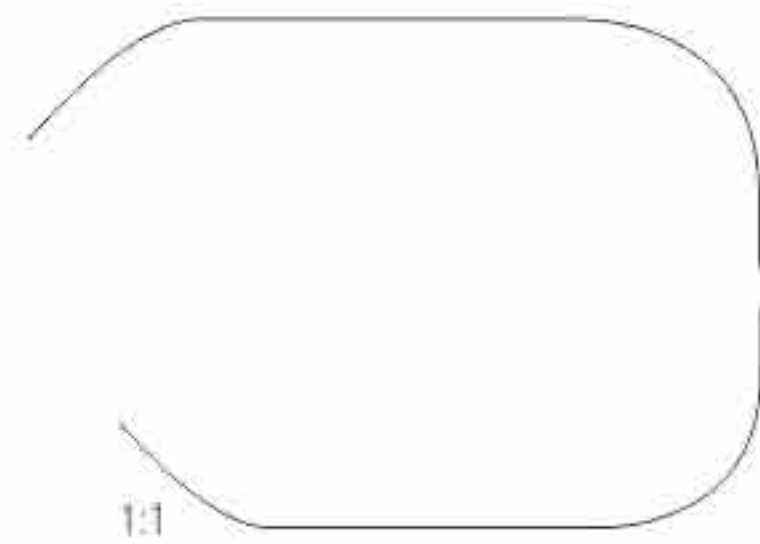
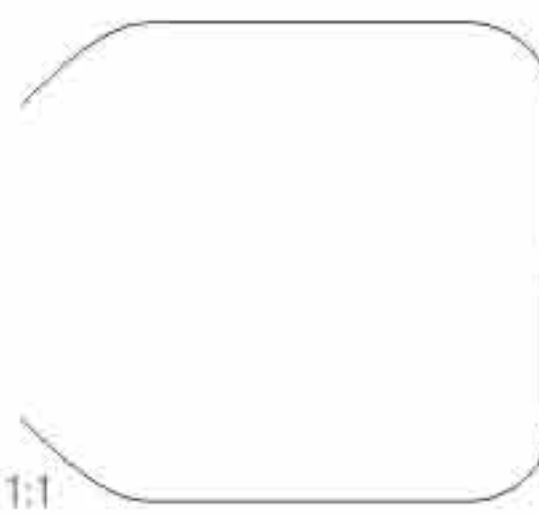

MATHIEU

200 mm – 8"	Fig. 1	Fig. 2
	42 mm x 13 mm	47 mm x 13 mm
	42 mm x 26 mm	46 mm x 26 mm
	01-2431-01	01-2431-02

01-2431-03	x	x
------------	---	---

Set

Retractors



FARABEUF

1:1

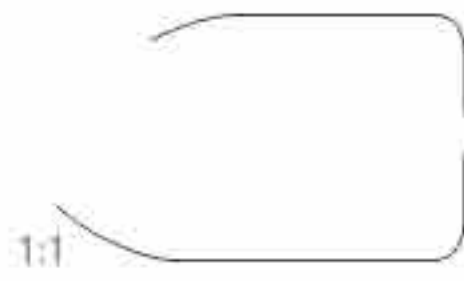

1:1

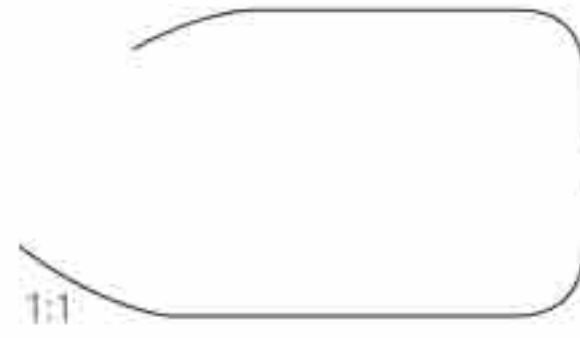

120 mm – 4 3/4 "	Fig. 1	Fig. 2
	26 mm x 10 mm	30 mm x 10 mm
	30 mm x 12 mm	34 mm x 12 mm

01-2432-01	x	x
------------	---	---

Set



FARABEUF

1:1

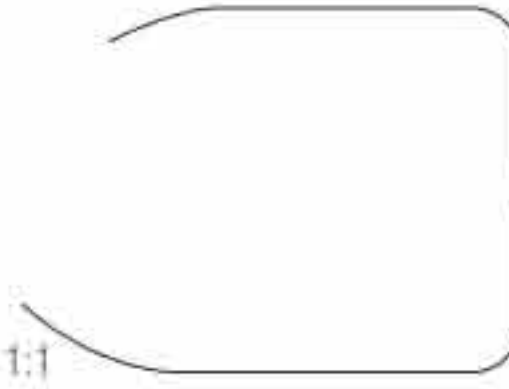

1:1

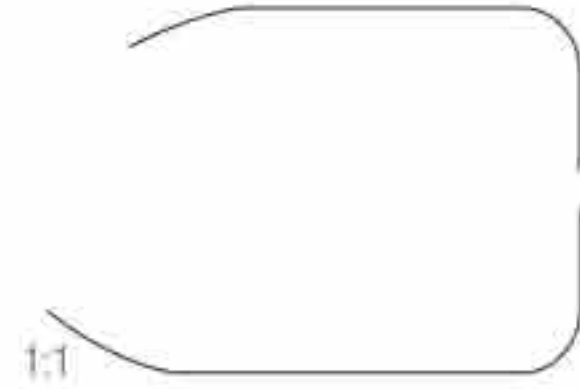

150 mm – 6 "	Fig. 1	Fig. 2
	23 mm x 16 mm	27 mm x 16 mm
	26 mm x 16 mm	30 mm x 16 mm

01-2432-02	x	x
------------	---	---

Set

Retractors



ALM

70 mm - 2 3/4 "	01-2433-01	01-2434-01	01-2435-01
100 mm - 4 "	01-2433-02	01-2434-02	01-2435-02

sharp

semi sharp

blunt



BOSE

1:2

70 mm - 2 3/4 "	01-2436
-----------------	---------



HOLTZHEIMER 1:2

100 mm - 4 "	01-2437	01-2438
--------------	---------	---------

sharp

blunt



JANSEN 1:2

100 mm - 4 "	01-2439	01-2440
--------------	---------	---------

sharp

blunt

Self-retaining retractors



CLOWARD-CONTOUR 1:2

140 mm – 5 ½ "	01-2441	01-2442
	3 x 4	3 x 4
	sharp	blunt



WEITLANER-WULLSTEIN 1:2

130 m – 5 "	01-2443	01-2444
	3 x 3	3 x 3
	sharp	blunt



MILLIGAN 1:2

130 mm – 5 "	01-2445
	3 x 3
	blunt

Self-retaining retractors



1:2



1:2

BELLUCCI

110 mm – 4 ¼ "	01-2446	01-2447
-----------------------	---------	---------

1 x 2

1 x 2

left, blunt

right, blunt



1:2

MOLLISON

150 mm – 6 "	01-2448
---------------------	---------

4 x 4

sharp

Self-retaining retractors

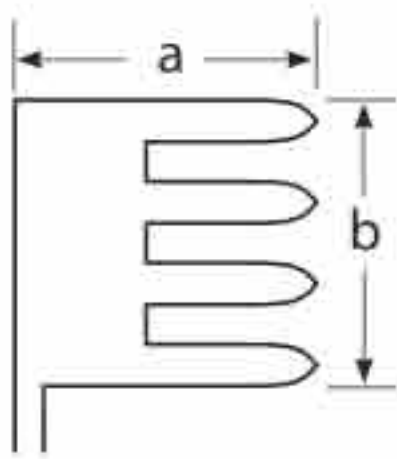

WEITLANER-LOKTITE

105 mm – 4 ¼ "	a = 17 mm – b = 13 mm	01-2449	01-2450	01-2451			
130 mm – 5 "	a = 17 mm – b = 17 mm				01-2452-01	01-2453-01	01-2454-01
165 mm – 6 ½ "	a = 17 mm – b = 17 mm				01-2452-02	01-2453-02	01-2454-02
200 mm – 8 "	a = 20 mm – b = 19 mm				01-2452-03	01-2453-03	01-2454-03
260 mm – 10 ¼ "	a = 26 mm – b = 21 mm				01-2452-04	01-2453-04	01-2454-04

2 x 3

2 x 3

2 x 3

3 x 4

3 x 4

3 x 4

sharp

semi sharp

blunt

sharp

semi sharp

blunt

Self-retaining retractors



1:2

PLESTER

130 mm – 5"	01-2455	01-2456
	2 x 2	2 x 2
	blunt	sharp

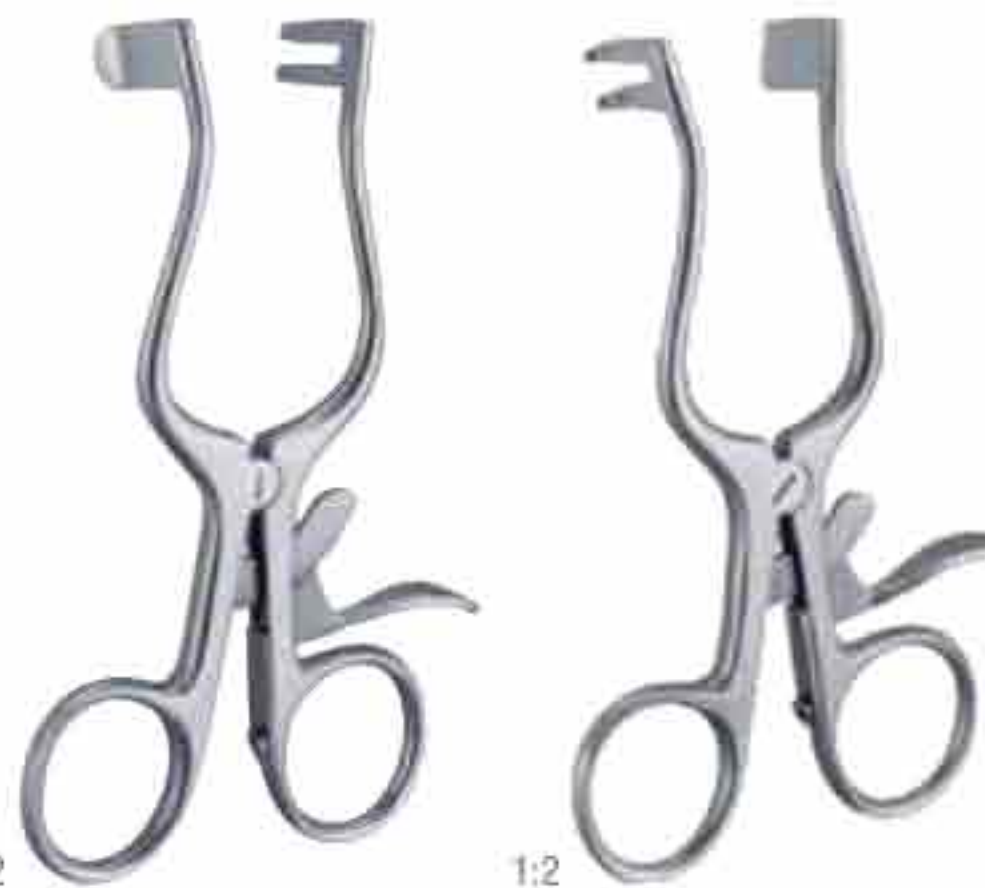

PLESTER

1:2

1:2

110 mm – 4 1/4"	01-2457	01-2458
	2 x 1	2 x 1
	left, blunt	right, blunt

Self-retaining retractors



1:2

**NORFOLK
ANDNORWHICH**

220 mm – 8¾"	01-2459
--------------	---------

4 x 5

blunt



1:2

TRAVERS

215 mm – 8½"	01-2460
--------------	---------

4 x 5

blunt



1:2

ANDERSON-ADSON

195 mm – 7¾"	01-2461	01-2462
--------------	---------	---------

4 x 4

sharp

4 x 4

blunt

Self-retaining retractors



ADSON (CONE)

130 mm – 5"	a = 17 mm – b = 19 mm	01-2463-01	01-2464-01
160 mm – 6 ¼"	a = 17 mm – b = 19 mm	01-2463-02	01-2464-02
200 mm – 8"	a = 20 mm – b = 20 mm	01-2463-03	01-2464-03
260 mm – 10 ¼"	a = 26 mm – b = 21 mm	01-2463-04	01-2464-04

3 x 4

sharp

3 x 4

blunt



1:2

BECKMANN-EATON

320 mm – 12 ½"
01-2465

7 x 7

sharp

Self-retaining retractors

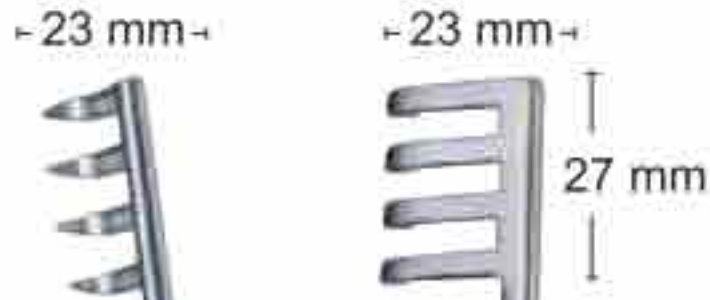

beCKmaNN

310 mm – 12 ¼"	01-2466	01-2467	01-2468
	4 x 4	4 x 4	4 x 4
	sharp	semi sharp	blunt

1:2



aDsoN

		265 mm – 10 ½"	265 mm – 10 ½"
3 x 4	a = 24 mm – b = 24 mm	01-2469-01	01-2470-01
6 x 6	a = 40 mm – b = 40 mm	01-2469-02	01-2470-02

sharp

blunt

1:2

Self-retaining retractors

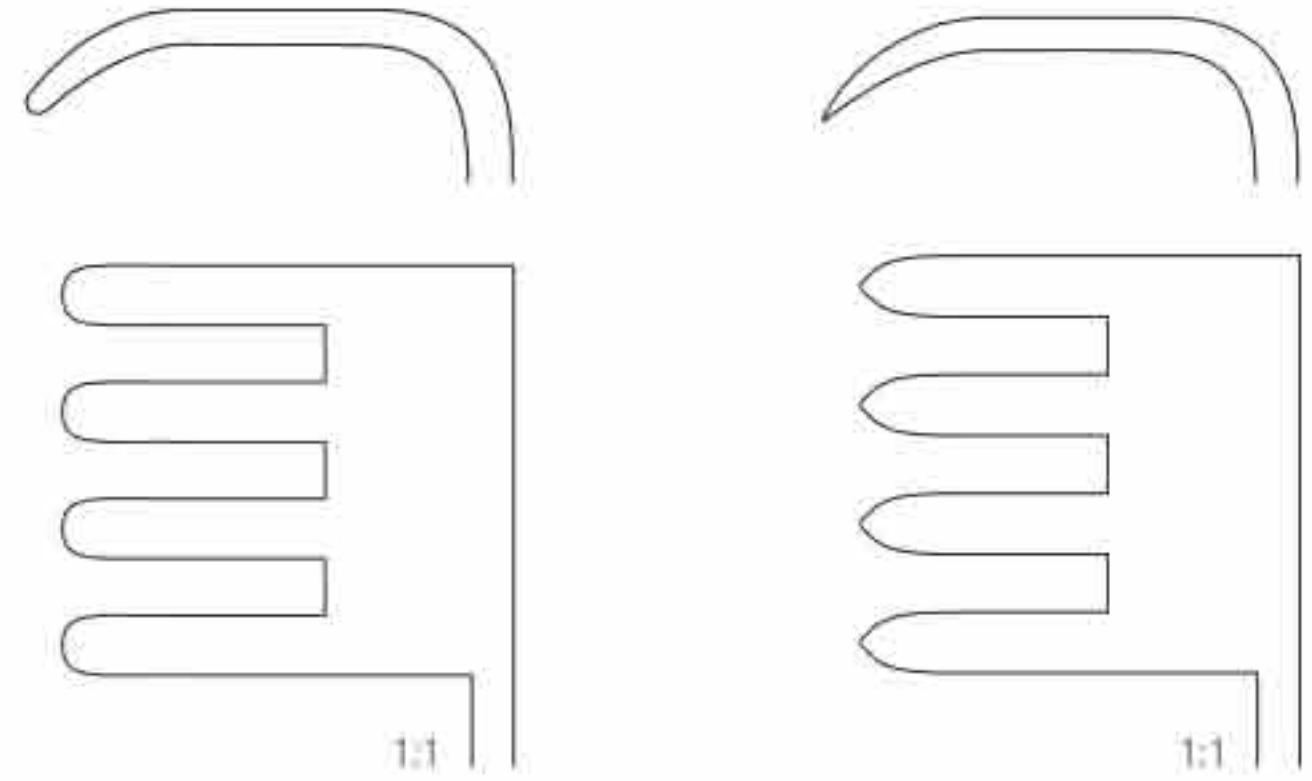

BECKMANN-ADSON

310 mm – 12 ¼"	01-2471-01	01-2471-02
-----------------------	------------	------------

blunt

sharp

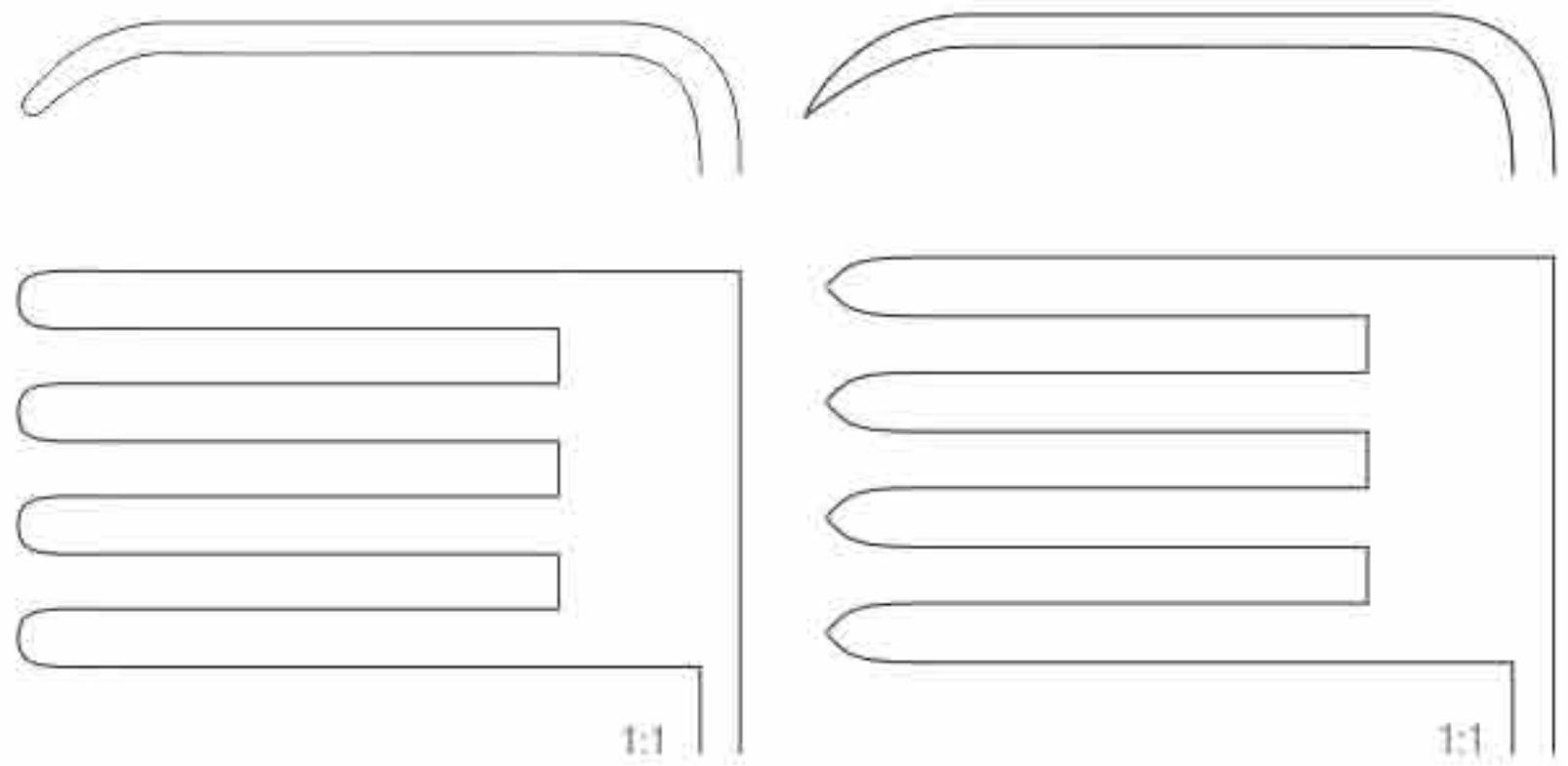

01-2471-03	01-2471-04
------------	------------

blunt, with deep blades

sharp, with deep blades

Self-retaining retractors



1:2
HENLEY

165 mm – 6 ½ "	01-2478	01-2479
	3 x 4	3 x 4
	sharp	blunt

complete with 3 center blades



19 mm x 16 mm	25 mm x 16 mm	32 mm x 16 mm
01-2480-01	01-2480-02	01-2480-03

Center blades

Abdominal retractors



BABY-COLLIN

180 mm – 7"		
x = 80 mm		
01-2481	40 mm x 18 mm	40 mm x 27 mm

complete with 2 pairs of blades



COLLIN 1:2

220 mm – 8 3/4"	x = 100 mm	01-2482
-----------------	------------	---------



COLLIN

225 mm – 8 3/4"		
x = 100 mm		
01-2483	a = 38 mm – b = 55 mm	a = 38 mm – b = 55 mm
01-2484	a = 38 mm – b = 80 mm	a = 50 mm – b = 75 mm

complete with Lateral blades Center blade

Abdominal retractors



COLLIN 1:2

260 mm – 10 ½ "		
x = 160 mm		
01-2484	60 mm x 80 mm	60 mm x 75 mm

complete with: Lateral blades Center blade



HOLZBACH 1:2

260 mm – 10 ¼ "		
x = 100 mm		
01-2485	62 mm x 80 mm	80 mm x 80 mm

complete with: Lateral blades Center blade

Abdominal retractors



GOSSET

1:2

125 mm – 5"	x = 100 mm	01-2486
-------------	------------	---------



GOSSET

1:2

185 mm – 7 1/4"	x = 140 mm	01-2487
-----------------	------------	---------

Abdominal retractors



GOSSET

1:3

x = 160 mm		
01-2488	35 mm x 63 mm	65 mm x 70 mm

complete with Lateral blades Center blade



BALFOUR

1:3

x = 200 mm		
01-2489	35 mm x 100 mm	70 mm x 100 mm

complete with Lateral blades Center blade

Abdominal retractors



BALFOUR

x = 180 mm		
01-2490	35 mm x 70 mm	45 mm x 80 mm

complete with Lateral blades Center blade

x = 250 mm		
01-2491	35 mm x 100 mm	70 mm x 85 mm

complete with Lateral blades Center blade

45 mm x 80 mm	01-2492-01
70 mm x 85 mm	01-2492-02
80 mm x 90 mm	01-2492-03

Center blades, only



BALFOUR-BABY

x = 90 mm		
01-2493	27 mm x 27 mm	20 mm x 24 mm

complete with Lateral blades Center blade

Abdominal retractors



RICARD

1:3

01-2494-01	60 mm x 80 mm	55 mm x 70 mm
------------	---------------	---------------

complete with Lateral blades Center blade

01-2494-02	70 mm x 85 mm	80 mm x 90 mm
------------	---------------	---------------

complete with Lateral blades Center blade



**O'SULLIVAN-
O'CONNOR**

1:3

01-2495	45 mm x 90 mm	70 mm x 100 mm
---------	---------------	----------------

complete with Lateral blades Center blade

Abdominal retractors

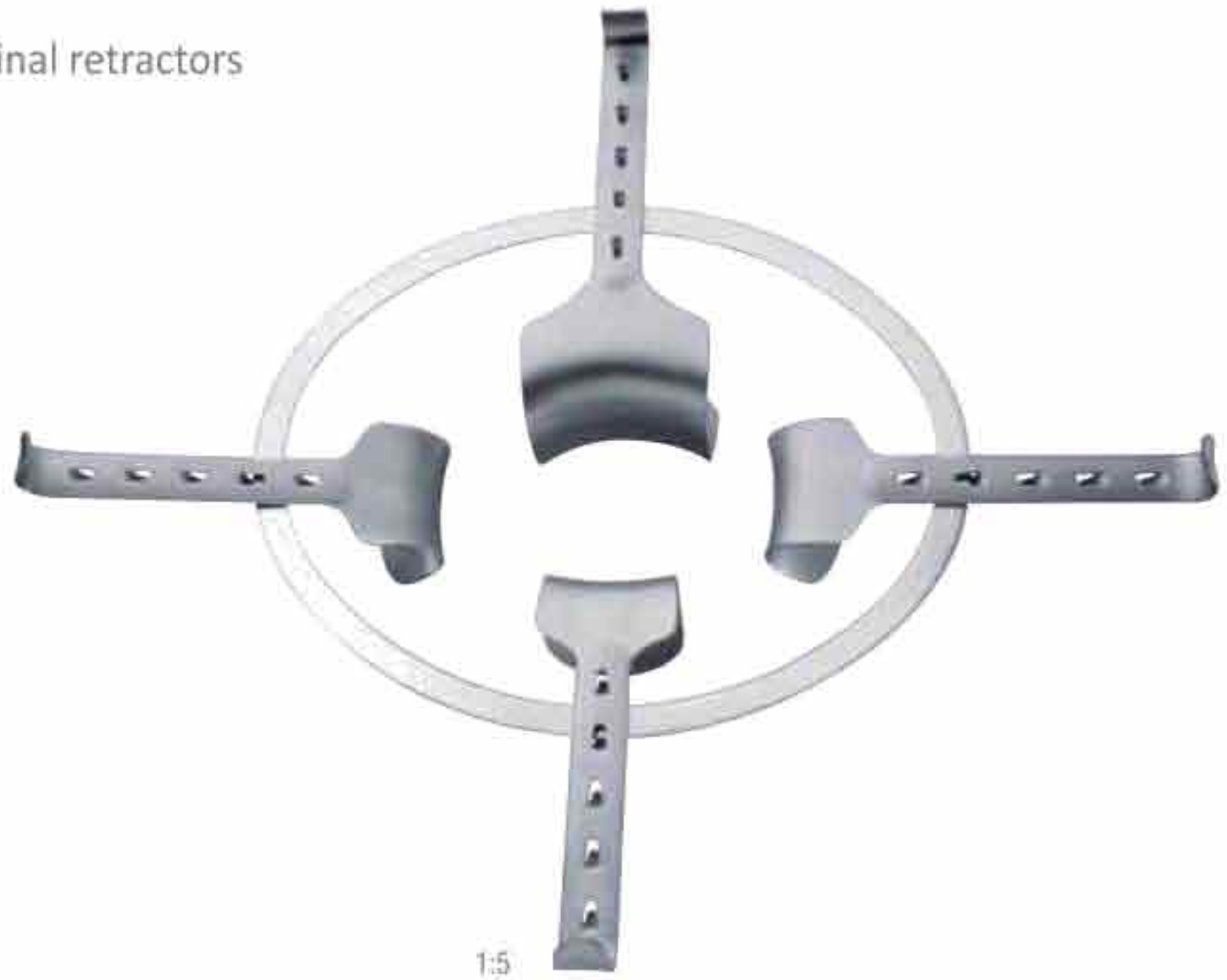

KIRSCHNER, OVAL

1:5

240 mm x 300 mm	50 mm x 65 mm	80 mm x 90 mm	50 mm x 98 mm	35 mm x 105 mm
01-2496	01-2497	01-2498	01-2499	01-2500

1 Frame 3 Blades 1 Blade 1 Blade 1 Blade

01-2501	x	x	x	x	x
---------	---	---	---	---	---

Set

KIRSCHNER

240 mm x 240 mm	40 mm x 55 mm	50 mm x 65 mm
01-2502	01-2503	01-2504

1 Frame, rigid 2 Blades 2 Blades

01-2505	x	x	x
---------	---	---	---

Set

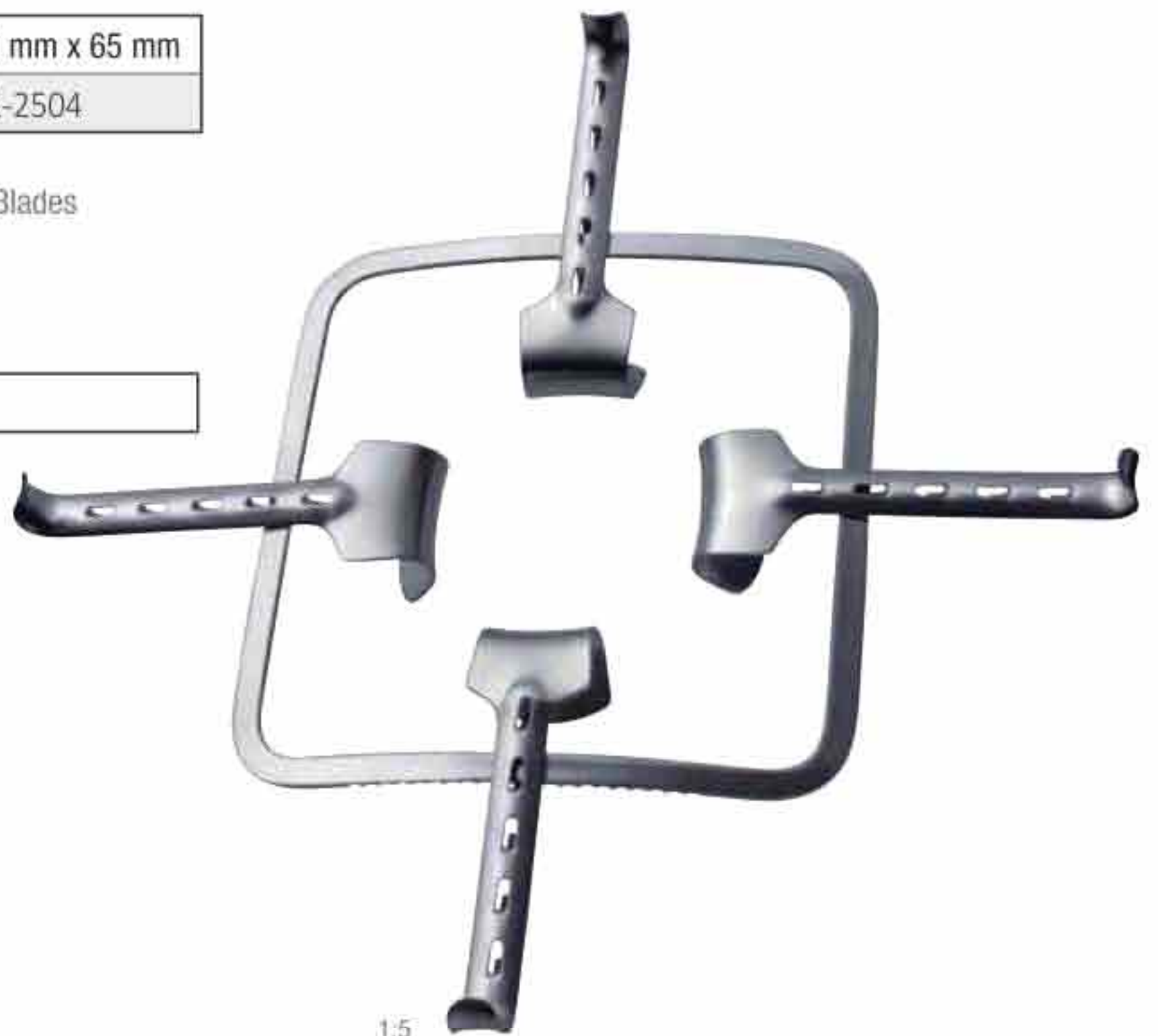

1:5

Abdominal retractors



1:4

FRANZ

300 mm x 300 mm	40 mm x 60 mm	45 mm x 80 mm	50 mm x 65 mm	60 mm x 85 mm
01-2506	01-2507	01-2508	01-2509	01-2510

1 Frame, foldable

2 Blades

2 Blades

2 Blades

2 Blades

01-2511	x	x		x	
01-2512	x	x	x	x	x

Set



1:4

Abdominal retractors



40 mm x 60 mm	45 mm x 80 mm	40 mm x 55 mm	50 mm x 65 mm
01-2513-01	01-2513-01	01-2514-01	01-2514-02



60 mm x 85 mm	80 mm x 90 mm	50 mm x 98 mm	35 mm x 105 mm
01-2515-01	01-2515-02	01-2515-03	01-2515-04

Retractors



O'SULLIVAN-O'CONNOR

Fig. 1	Fig. 2	Fig. 3	Set
45 mm x 17 mm	90 mm x 37 mm	90 mm x 45 mm	Fig. 1, 2, 3
01-2516-01	01-2516-02	01-2516-03	01-2516-04

complete



FRIEDMANN 1:2

100 mm - 4"	01-2517
-------------	---------

Laminectomy retractors



CLOWARD

1:3

1:3

160 mm – 6 ¼ "	250 mm – 9 ¾ "
01-2518-01	01-2519-01

complete with 2 blades ea. Fig. 1 - Fig. 5

complete with 2 blades ea. Fig. 1 - Fig. 5

01-2518-02	01-2519-02
------------	------------

Retractor without blades

Retractor without blades

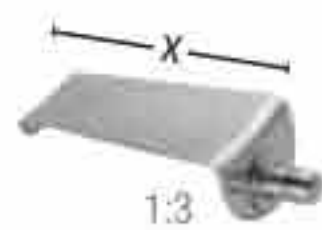

1:3

x = 40 mm	01-2520-01
x = 45 mm	01-2520-02
x = 50 mm	01-2520-03
x = 55 mm	01-2520-04
x = 60 mm	01-2520-05

blunt

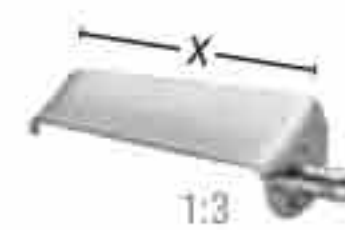

1:3

x = 40 mm	01-2521-01
x = 45 mm	01-2521-02
x = 50 mm	01-2521-03
x = 55 mm	01-2521-04
x = 60 mm	01-2521-05

toothed

Laminectomy retractors

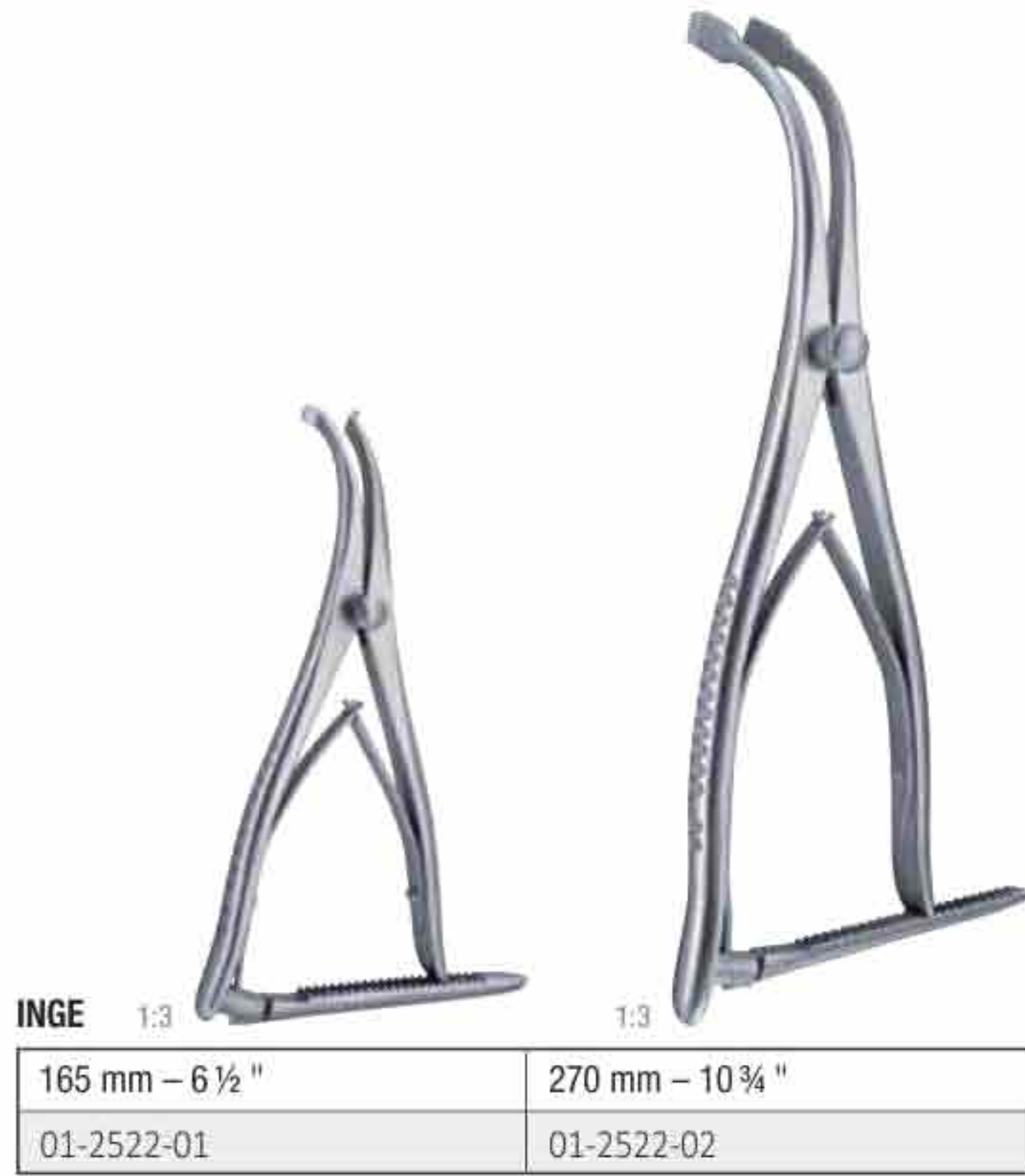

Laminectomy retractors

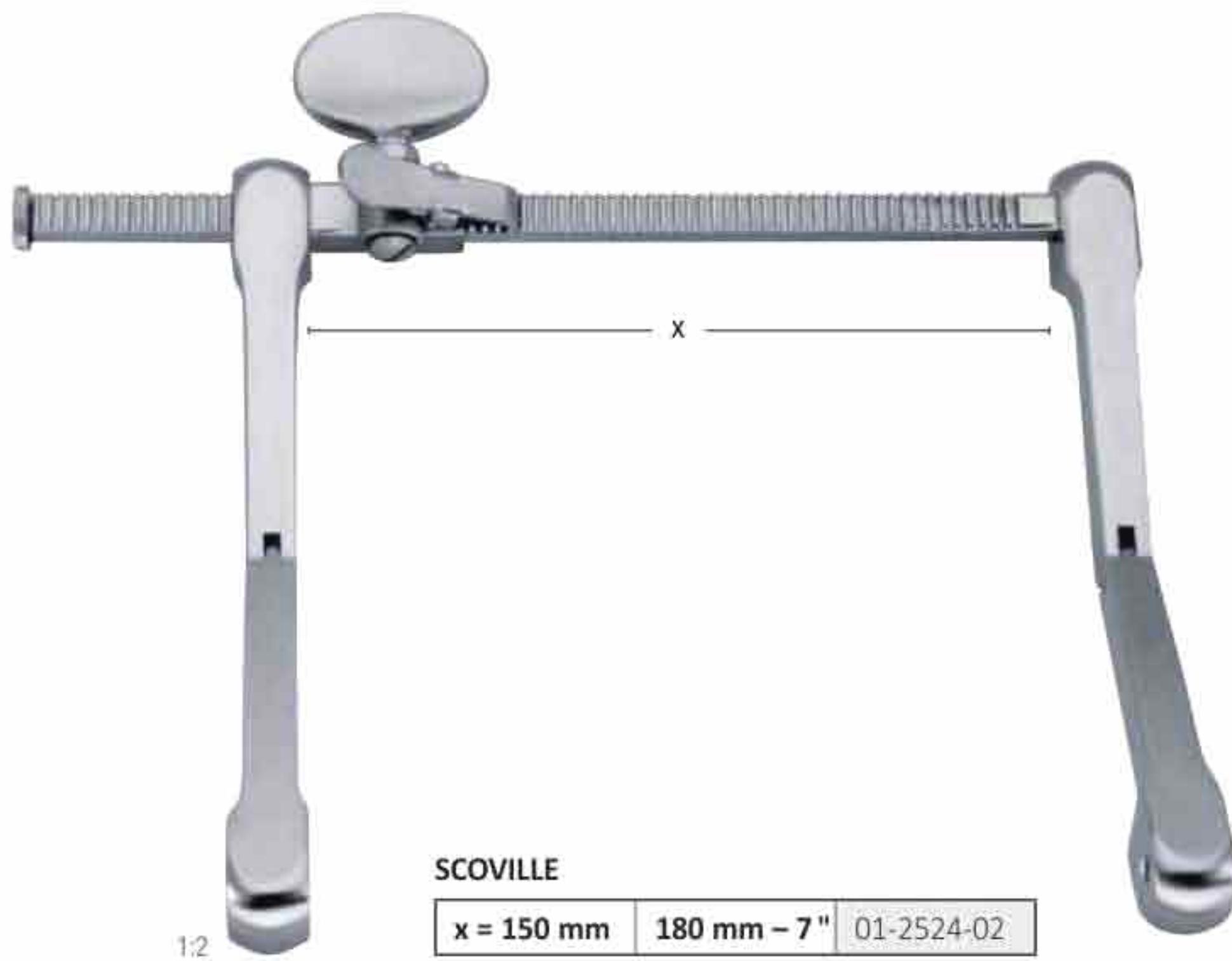
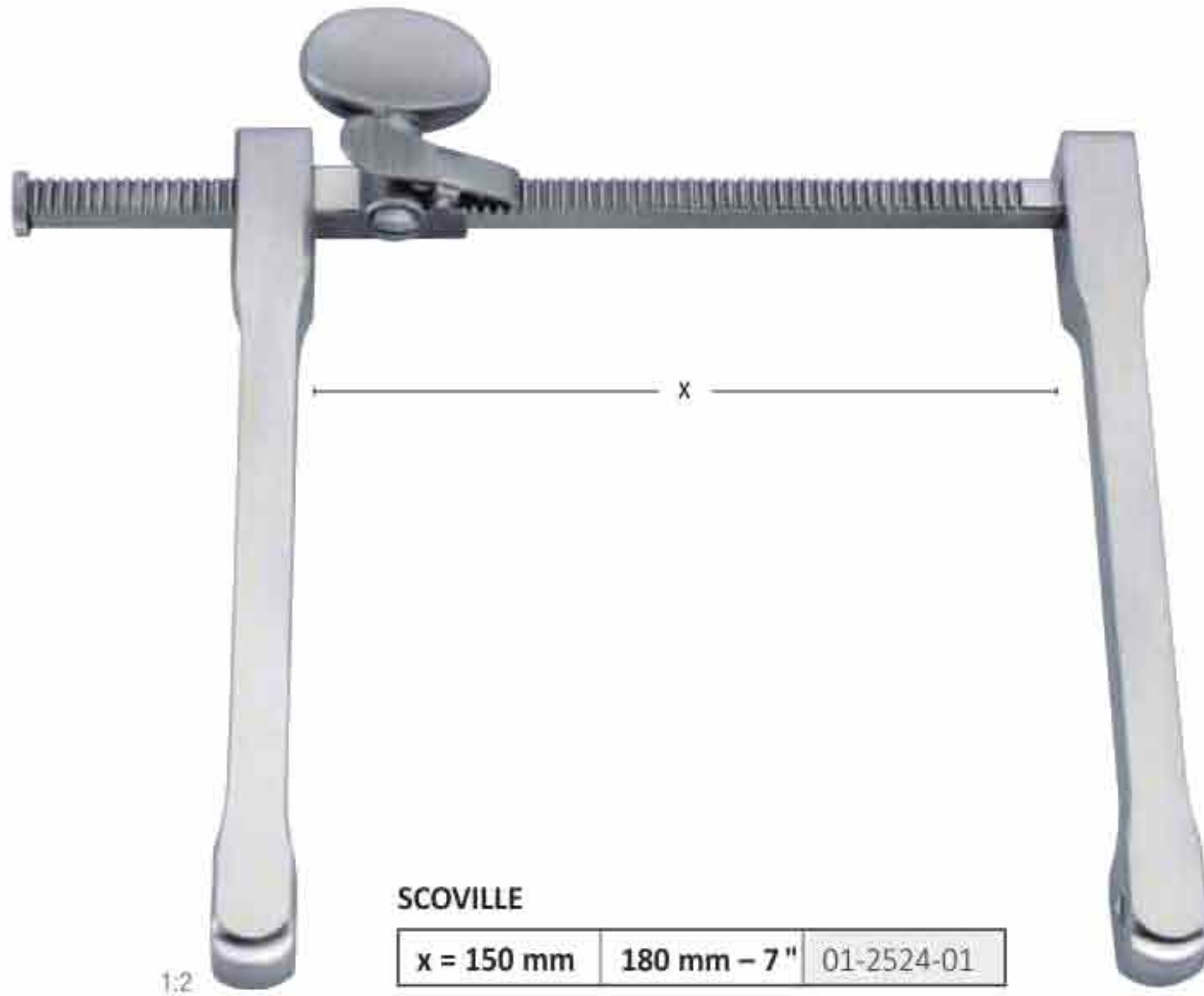

Laminectomy retractors

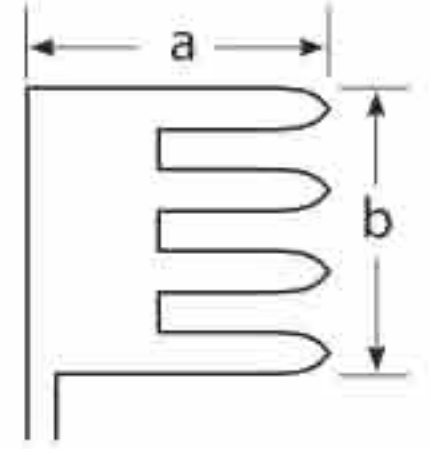

SCOVILLE

50 mm – 2"	01-2525-01	01-2525-03
70 mm – 2 ¾"	01-2525-02	01-2525-04

blunt

sharp



TAYLOR

a = 48 mm – b = 50 mm – 2" x 2"	01-2525-05
a = 63 mm – b = 50 mm – 2 ½" x 2"	01-2525-06
a = 64 mm – b = 64 mm – 3 ¼" x 2 ¼"	01-2525-07
a = 80 mm – b = 57 mm – 3" x 2"	01-2525-08



SCOVILLE

a = 40 mm – b = 37 mm – 1 ½" x 1 ½"	01-2525-09
a = 65 mm – b = 44 mm – 2 ½" x 1 ¾"	01-2525-10



TAYLOR

a = 75 mm – b = 32 mm – 3" x 1 ¼"	01-2525-11
a = 100 mm – b = 42 mm – 4" x 1 ⅔"	01-2525-12

Laminectomy retractors

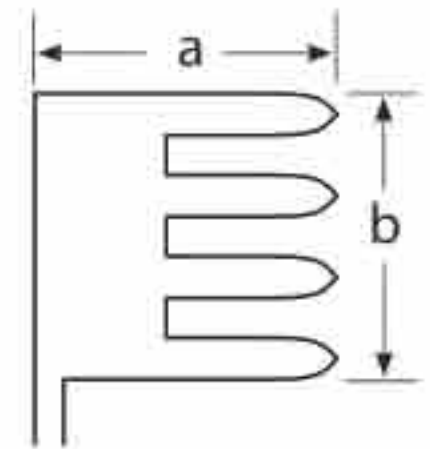

MEYERDING

a = 57 mm – b = 25 mm – 2¼" x 1"	01-2525-13
a = 76 mm – b = 25 mm – 3" x 1"	01-2525-14
a = 88 mm – b = 51 mm – 3½" x 2"	01-2525-15



SCOVILLE

a = 64 mm – b = 25 mm – 2½" x 1"	01-2525-16
a = 64 mm – b = 50 mm – 2½" x 2"	01-2525-17
a = 88 mm – b = 25 mm – 3½" x 1"	01-2525-18



EPSTEIN

1:2

a = 56 mm – b = 25 mm – 2¼" x 1"	01-2525-19
----------------------------------	------------



HIBBS

a = 50 mm – b = 20 mm – 2" x ¾"	01-2526-01
a = 50 mm – b = 25 mm – 2" x 1"	01-2526-02
a = 50 mm – b = 50 mm – 2" x 2"	01-2526-03
a = 63 mm – b = 25 mm – 2½" x 1"	01-2526-04
a = 63 mm – b = 37 mm – 2½" x 1½"	01-2526-05
a = 76 mm – b = 25 mm – 3" x 1"	01-2526-06
a = 76 mm – b = 38 mm – 3" x 1½"	01-2526-07
a = 76 mm – b = 50 mm – 3" x 2"	01-2526-08
a = 76 mm – b = 63 mm – 3" x 2½"	01-2526-09
a = 90 mm – b = 25 mm – 3½" x 1"	01-2526-10
a = 90 mm – b = 37 mm – 3½" x 1½"	01-2526-11
a = 102 mm – b = 25 mm – 4" x 1"	01-2526-12
a = 102 mm – b = 50 mm – 4" x 2"	01-2526-13

Laminectomy retractors



CASPAR 1:2

01-2527-01



1:2

01-2528-01

complete with 5 medial blades 318-714-400 – 318-714-600
and with 5 lateral blades 318-715-400 – 318-715-600

complete with 5 blades 318-712-450 – 318-712-650

01-2527-02

01-2528-02

Retractor without blades

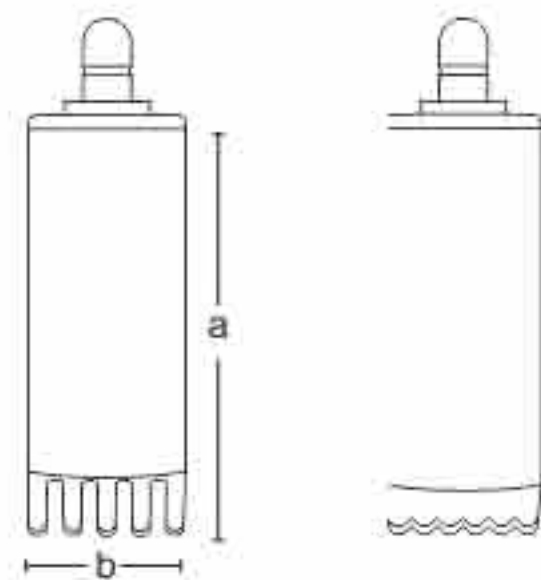

CASPAR

	medial	lateral
a = 40 mm – b = 23 mm	01-2529-01	01-2530-01
a = 45 mm – b = 23 mm	01-2529-02	01-2530-02
a = 50 mm – b = 23 mm	01-2529-03	01-2530-03
a = 55 mm – b = 23 mm	01-2529-04	01-2530-04
a = 60 mm – b = 23 mm	01-2529-05	01-2530-05

Retractor without blades



CASPAR

a = 45 mm – b = 23 mm	01-2531-01
a = 50 mm – b = 23 mm	01-2531-02
a = 55 mm – b = 23 mm	01-2531-03
a = 60 mm – b = 23 mm	01-2531-04
a = 65 mm – b = 23 mm	01-2531-05

blunt

Laminectomy retractors



CASPAR

01-2532-01

complete with 5 blades 318-712-450 – 318-712-650

01-2532-02

Retractor without blades



01-2532-03

Key

Laminectomy retractors



CASPAR

1:1



1:1

38 mm	58 mm
01-2533-01	01-2533-02

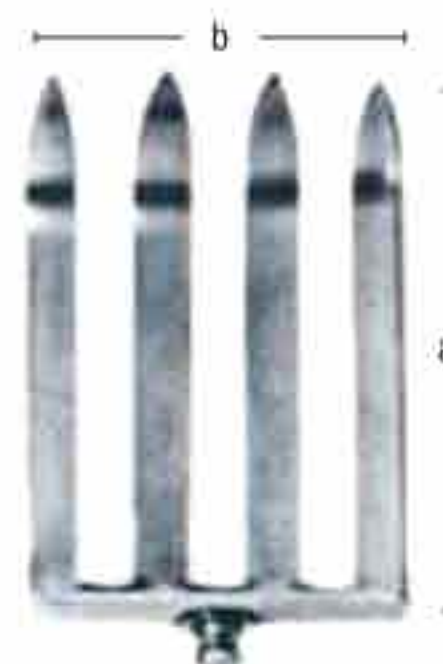
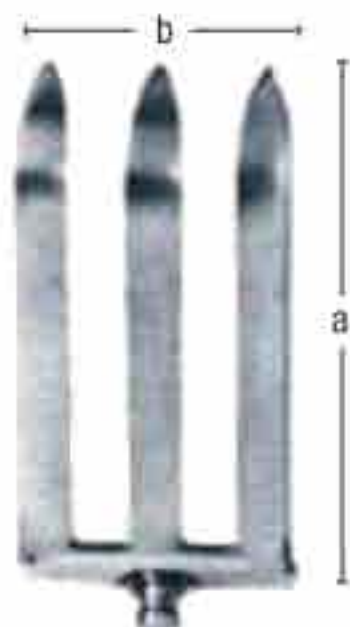
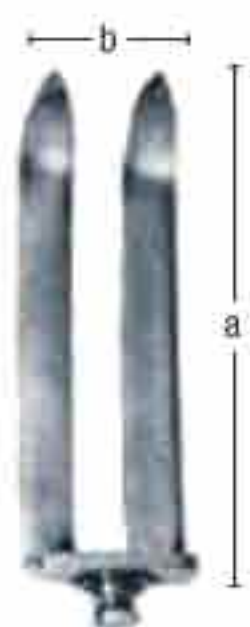

a = 35 mm – b = 22 mm	01-2534-01
a = 40 mm – b = 22 mm	01-2534-02
a = 45 mm – b = 22 mm	01-2534-03
a = 50 mm – b = 22 mm	01-2534-04
a = 55 mm – b = 22 mm	01-2534-05
a = 60 mm – b = 22 mm	01-2534-06
a = 65 mm – b = 22 mm	01-2534-07
a = 70 mm – b = 22 mm	01-2534-08

a = 35 mm – b = 37 mm	01-2535-01
a = 40 mm – b = 37 mm	01-2535-02
a = 45 mm – b = 37 mm	01-2535-03
a = 50 mm – b = 37 mm	01-2535-04
a = 55 mm – b = 37 mm	01-2535-05
a = 60 mm – b = 37 mm	01-2535-06
a = 65 mm – b = 37 mm	01-2535-07
a = 70 mm – b = 37 mm	01-2535-08

a = 35 mm – b = 52 mm	01-2536-01
a = 40 mm – b = 52 mm	01-2536-02
a = 45 mm – b = 52 mm	01-2536-03
a = 50 mm – b = 52 mm	01-2536-04
a = 55 mm – b = 52 mm	01-2536-05
a = 60 mm – b = 52 mm	01-2536-06
a = 65 mm – b = 52 mm	01-2536-07
a = 70 mm – b = 52 mm	01-2536-08

Retractors for Micro-Lumbar Discectomy



Caspar 1:2

a = 40 mm	01-2537-01
a = 45 mm	01-2537-02
a = 50 mm	01-2537-03
a = 55 mm	01-2537-04
a = 60 mm	01-2537-05
a = 65 mm	01-2537-06
a = 75 mm	01-2537-07
a = 85 mm	01-2537-08



Caspar

a = 35 mm	01-2538-02	
a = 40 mm	01-2538-03	01-2539-01
a = 45 mm	01-2538-04	01-2539-02
a = 50 mm	01-2538-05	01-2539-03
a = 55 mm	01-2538-06	01-2539-04
a = 60 mm	01-2538-07	01-2539-05
a = 65 mm	01-2538-08	01-2539-06
a = 70 mm		01-2539-07
a = 75 mm	01-2538-09	
a = 85 mm	01-2538-10	



Caspar

01-2538-01

1:2

Speculum for hypophysectomy



x = 70 mm	01-2540-01
x = 90 mm	01-2540-02
x = 110 mm	01-2540-03

Speculum for trans-sphenoidal hypophysectomy

Mallets



DOYEN

	195 mm – 7¾"
25 mm Ø – 120 g	01-2541-01
30 mm Ø – 180 g	01-2541-02
35 mm Ø – 260 g	01-2541-03



COLLIN

	200 mm – 8"
30 mm Ø – 220 g	01-2542-01



HAJEK

	215 mm – 8½"
27 mm Ø – 140 g	01-2543-01



KIRK

	190 mm – 7½"
38 mm Ø – 750 g	01-2544-01

Mallets



PARTSCH

1:2

	180 mm – 7"
22 mm Ø – 200 g	01-2545



LUCAE

	190 mm – 7 ½"
19 mm Ø – 230 g	01-2546-01
25 mm Ø – 260 g	01-2546-02

Mallets



1:2

BERGMANN

245 mm – 9 ¾ "
45 mm Ø – 300 g
01-2547



1:2

OMBREDANNE

240 cm – 9 ½ "
40 mm Ø – 550 g
01-2548



HEATH

40 mm Ø – 700 g	185 mm – 7 ⅓ "	01-2549-01
45 mm Ø – 1000 g	200 mm – 8 "	01-2549-02

Copper filled head

Mallets



1:2

190 mm – 7 ½ "
250 mm Ø – 205 g
01-2550-01

Solid steel, with plastic faces

01-2550-02

Spare faces, 1 pair



1:2

COTTLE	240 g
185 mm – 7 ¼ "	01-2551

1 side flat / 1 side convex



WILLIGER

	240 mm – 9 ½ "
26 mm Ø – 300 g	01-2552-01
28 mm Ø – 340 g	01-2552-02
30 mm Ø – 400 g	01-2552-03

lead filled

Mallets



1:2

165 mm – 6 ½ "
20 mm Ø – 150 g
01-2553



1:2

MEAD

170 mm – 6 ¾ "
26 mm Ø – 320 g
01-2554

Steel solid, with plastic faces

01-2555

Spare faces, 1 pair

Mallets



1:2

225 mm – 8 ¾ "
37 mm Ø – 370 g
01-2556-01

Head solid steel, with Ferrozell faces

01-2556-02

Spare faces, 1 pair



1:2

240 mm – 9 ½ "
30 mm Ø – 480 g
01-2557

Head solid steel, with Ferrozell faces

Mallets



1:2

	42 mm Ø – 250 g	42 mm Ø – 400 g
260 mm – 10 ¼ "	01-2558-01	01-2558-02



1:2

	30 mm Ø – 450	50 mm Ø – 900 g
265 mm – 10 ½ "	01-2559-01	01-2559-02

Ferrozell, without lead Plastic, lead filled

Bone chisels and gouges

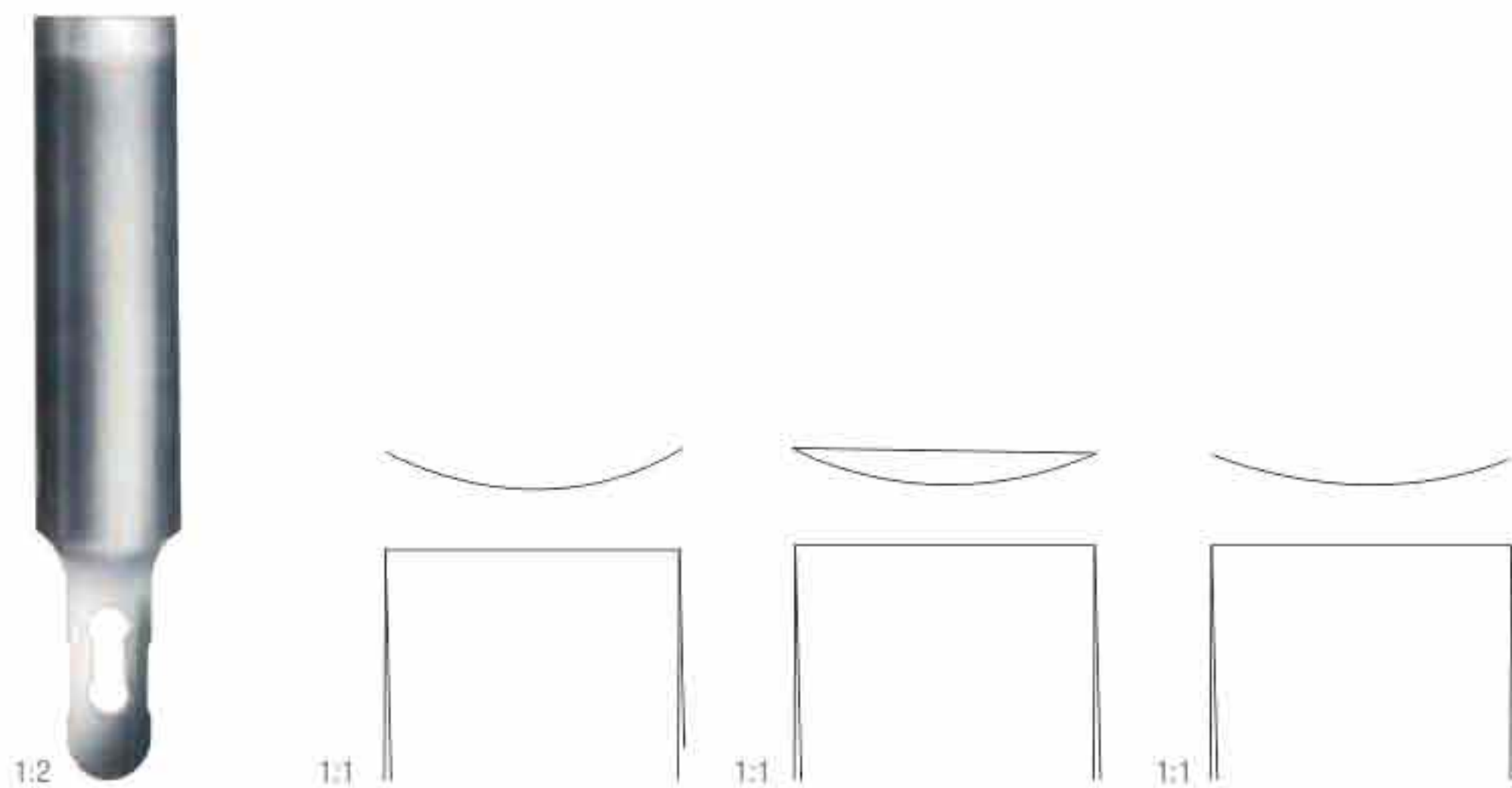

	25 mm (r = 50 m)	25 mm (r = 60 mm)	25 mm (r = 70 mm)
135 mm – 5 ¼ "	01-2560-01	01-2560-02	01-2560-03

Gouge blades, interchangeable

Bone chisels and gouges



1:2

185 mm – 7 ¼ "
01-2561-01

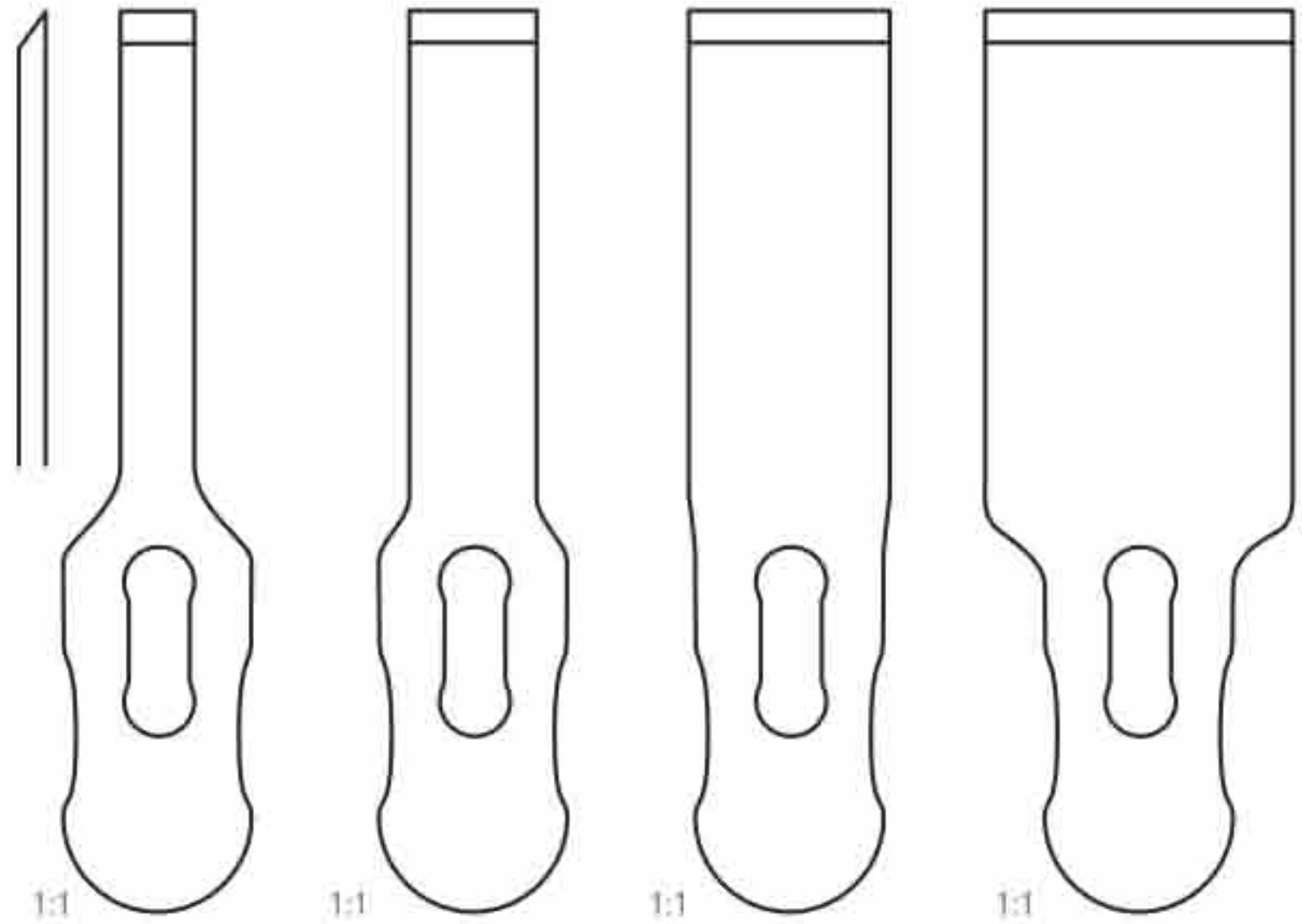

	5 mm	10 mm	16 mm	25 mm
85 mm – 3 ¼ "	01-2561-02	01-2561-03	01-2561-03	01-2561-04

Chisel blades, interchangeable



1:2

90 mm – 3 ½ "
01-2561-05

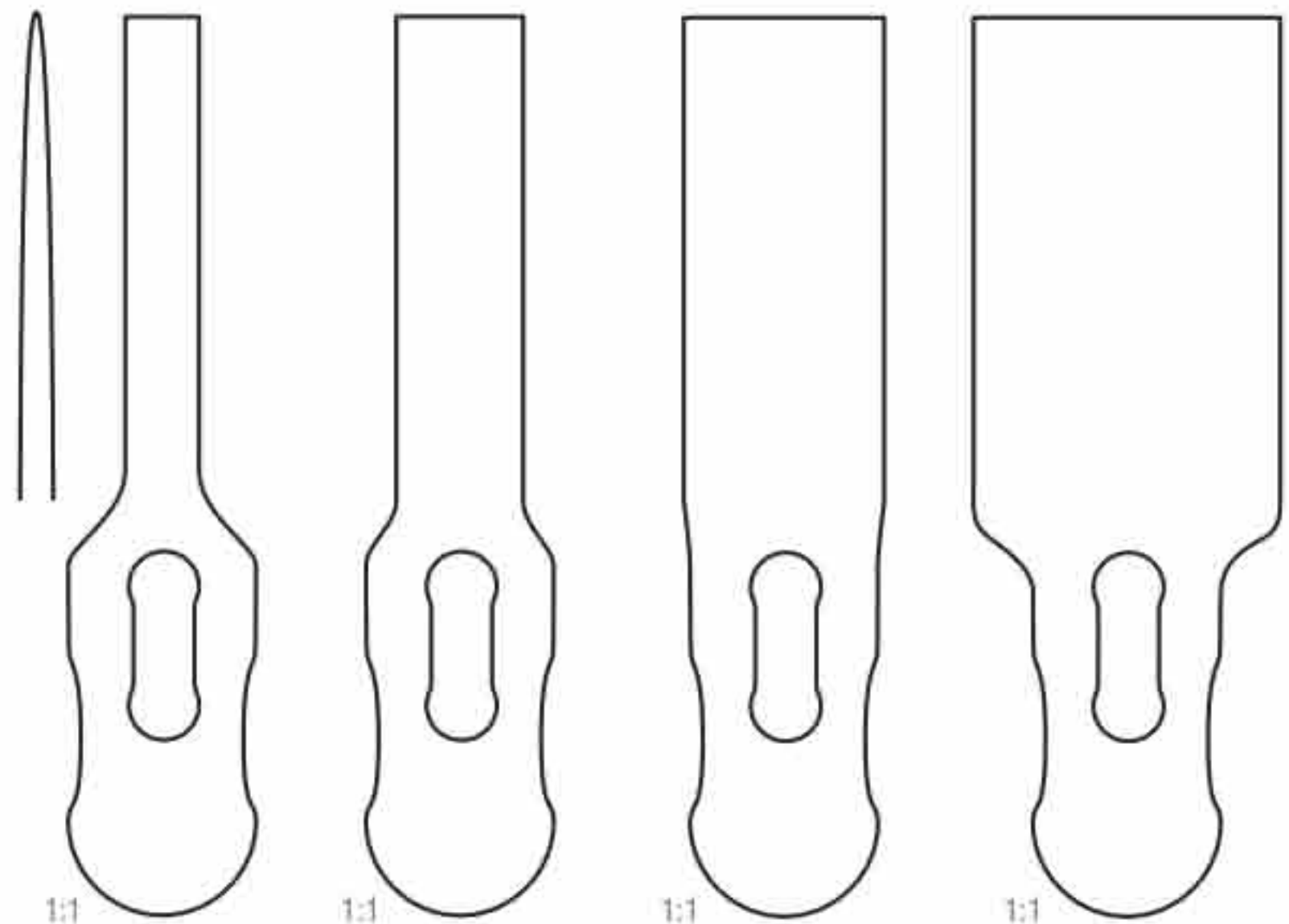

	5 mm	10 mm	16 mm	25 mm
85 mm – 3 ¼ "	01-2561-06	01-2561-07	01-2561-08	01-2561-09

Osteotome blades, interchangeable

Key

Bone chisels and gouges

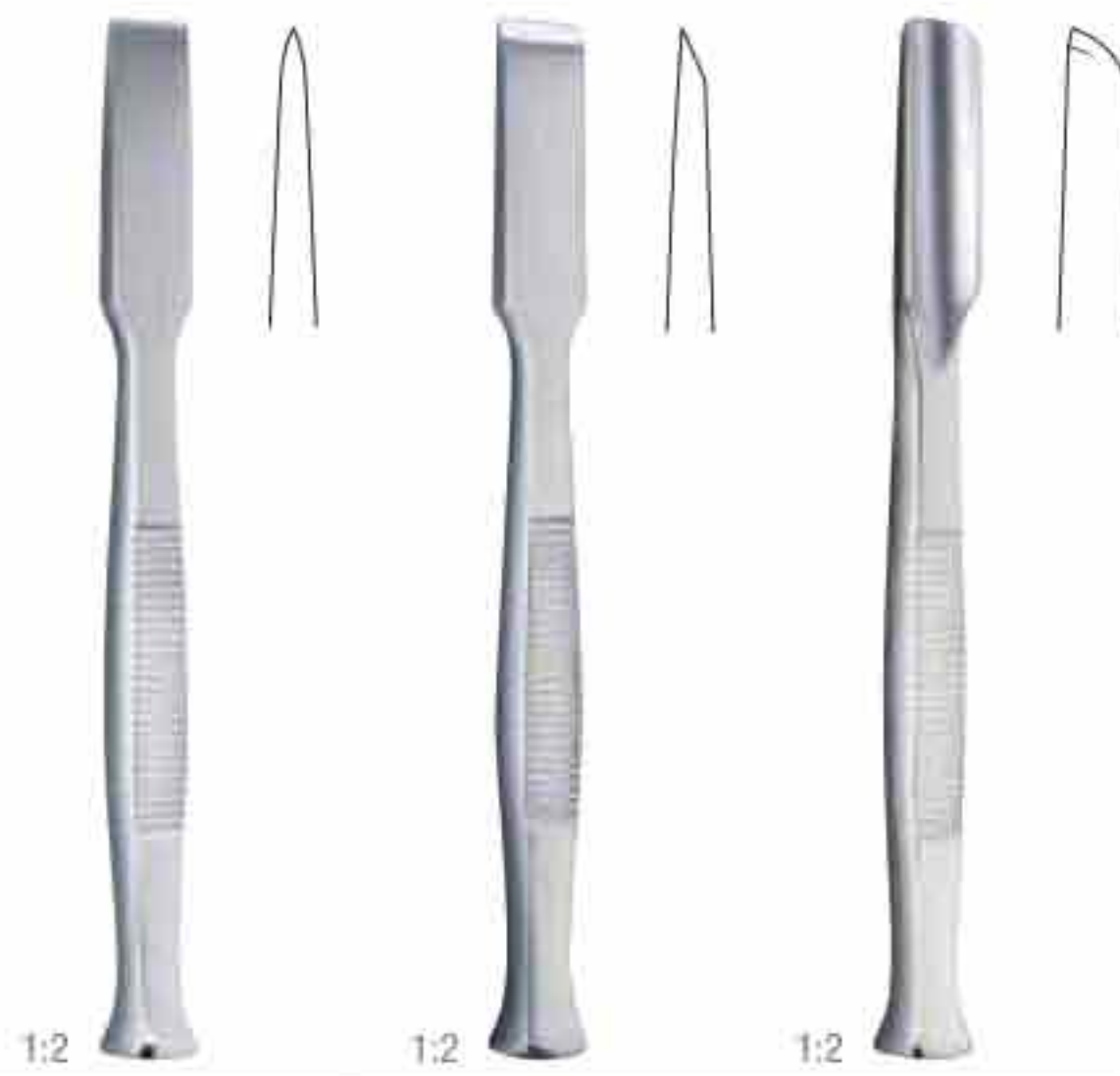

	135 mm – 5 ¼ "	135 mm – 5 ¼ "	135 mm – 5 ¼ "
4 mm			01-2564-01
6 mm	01-2562-01	01-2563-01	01-2564-02
8 mm	01-2562-02	01-2563-02	01-2564-03
10 mm	01-2562-03	01-2563-03	01-2564-04
12 mm	01-2562-04	01-2563-04	01-2564-05
14 mm	01-2562-05	01-2563-05	01-2564-06
16 mm	01-2562-06	01-2563-06	01-2564-07

Trocars



UNIVERSAL



	Fig. 1	Fig. 2	Fig. 3	Fig. 4
	6.0 mm \varnothing	4.5 mm \varnothing	3.0 mm \varnothing	1.75 mm \varnothing
01-2570-01		x	x	x
01-2570-02	x	x	x	x

Set



UCKERMANN

	8 mm \varnothing	10 mm \varnothing
130 mm – 5"	01-2571-01	01-2571-02

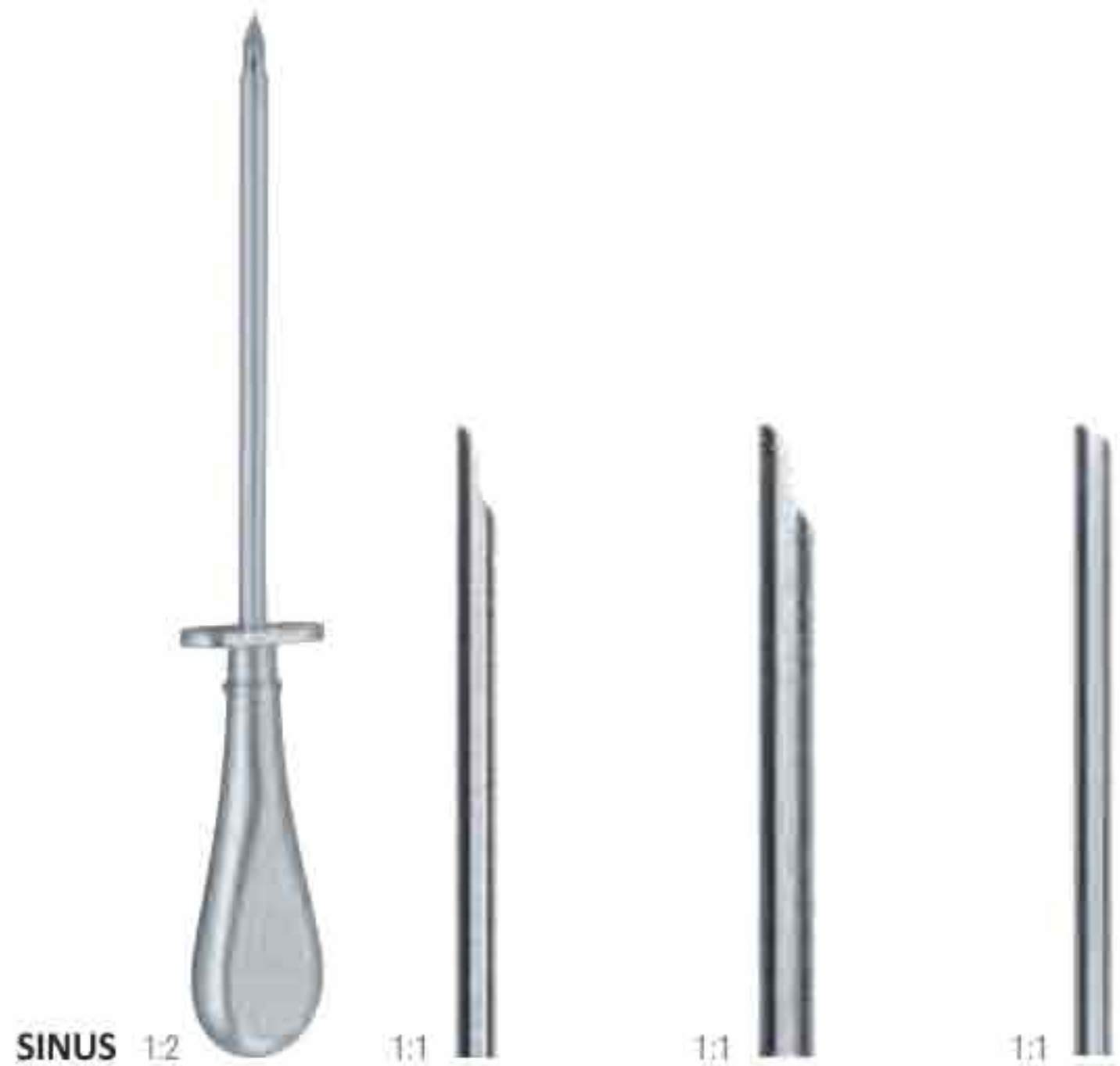

SINUS 1:2

	3.5 mm \varnothing	5.0 mm \varnothing	5.0 mm \varnothing
170 mm – 6 3/4"	01-2572-01	01-2572-02	01-2572-03

Trocars



LICHTWITZ

1:2

	1.5 mm Ø	1.8 mm Ø	2.0 mm Ø
190 mm – 7 ½ "	01-2573-01	01-2573-02	01-2573-03

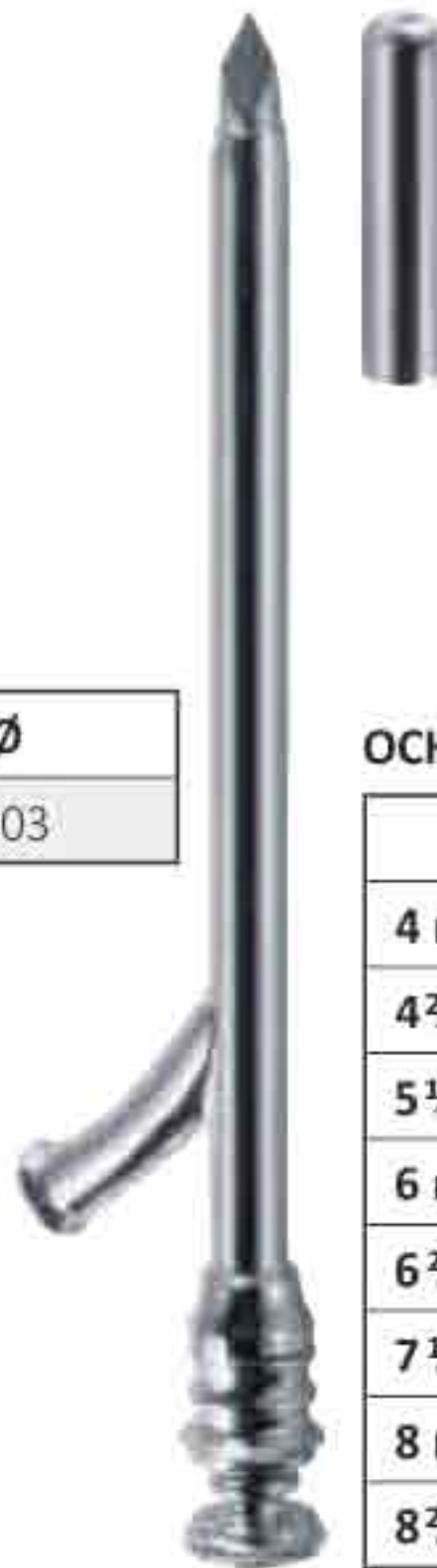

OCHSNER

		100 mm – 4 "
4 mm Ø	12 Char./Fr.	01-2574-01
4 ⅔ mm Ø	14 Char./Fr.	01-2574-02
5 ⅓ mm Ø	16 Char./Fr.	01-2574-03
6 mm Ø	18 Char./Fr.	01-2574-04
6 ⅔ mm Ø	20 Char./Fr.	01-2574-05
7 ⅓ mm Ø	22 Char./Fr.	01-2574-06
8 mm Ø	24 Char./Fr.	01-2574-07
8 ⅔ mm Ø	26 Char./Fr.	01-2574-08



1:2

NELSON

	7.5 mm Ø	10 mm Ø	11 mm Ø	11.6 mm Ø
210 mm – 8 ¼ "	01-2575-01	01-2575-02	01-2575-03	01-2575-04

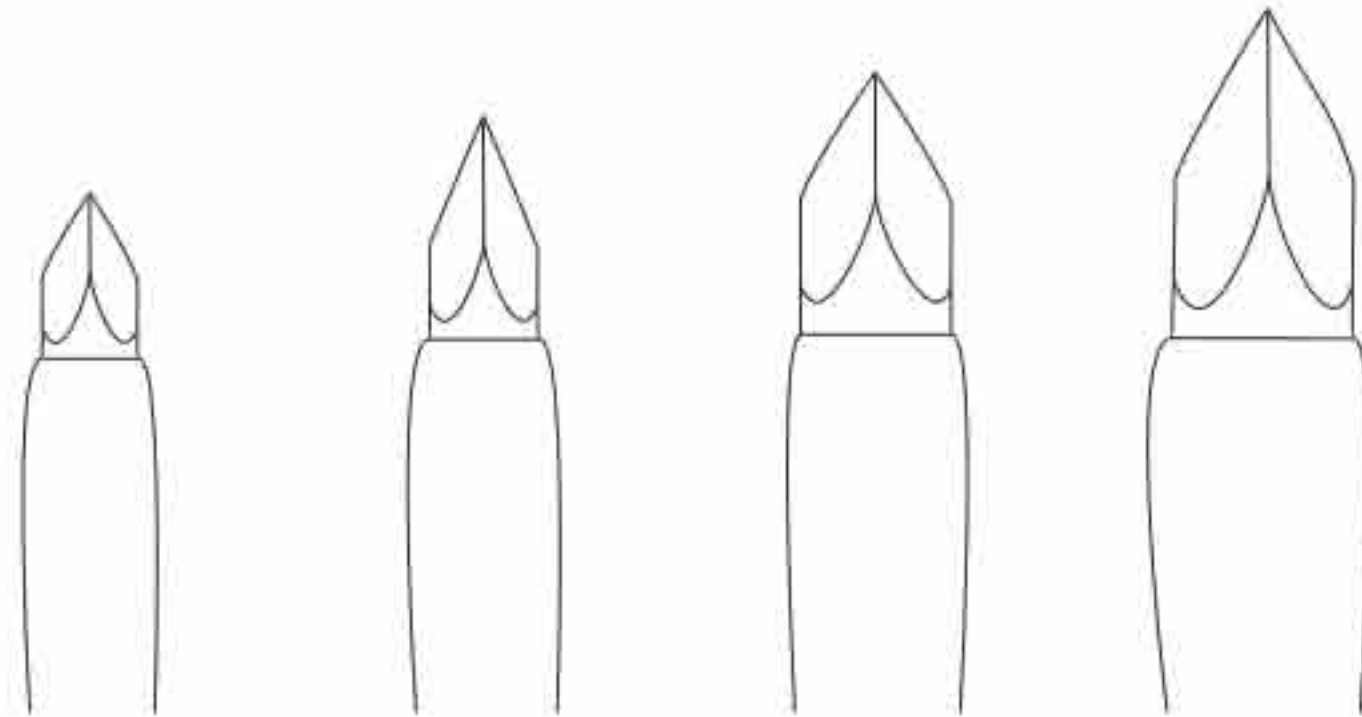

Trocars



LANDAU

1:2

	2 mm Ø
160 mm – 6 ¼ "	01-2576



PIERCE

	170 mm – 6 ¾ "
3 mm Ø	01-2577-01
4 mm Ø	01-2577-02
5 mm Ø	01-2577-03



KRAUSE

1:2

	5.5 mm Ø
150 mm – 6 "	01-2578



COAKLEY

1:2

	2.25 mm Ø
160 mm – 6 ¼ "	01-2579

Suction tubes



COOLEY

1:3

1:3

1:3

1:3

	8 mm Ø
350 mm – 13 ¾ "	01-2580

	10 mm Ø
310 mm – 12 ¼ "	01-2581

	6 mm Ø
300 mm – 12 "	01-2582

	8 mm Ø
330 mm – 13 "	01-2583

Suction tubes



1:3

POOLE

		220 mm – 8 "
8 mm Ø	23 Charr. / Fr.	01-2584



POOLE

		220 mm – 8 "
10 mm Ø	30 Charr./Fr.	01-2585



1:3

ANDREWS-PYNCHON

235 mm – 9 ¼ "	01-2586
----------------	---------



1:3

DE BAKEY

275 mm – 10 ¾ "	01-2587
-----------------	---------



01-2588-03



01-2588-02



1:3

YANKAUER

270 mm – 10 ¾ "	01-2588-01
-----------------	------------

Eustachian catheters



HARTMANN

1:2

1:2

	Fig. 1	Fig. 2
2.0 mm Ø	01-2589-01	01-2590-01
2.5 mm Ø	01-2589-02	01-2590-02
3.0 mm Ø	01-2589-03	01-2590-03



EICKEN-KILLIAN

1:2

130 mm – 6"	2.0 mm Ø	01-2591-01
130 mm – 6"	2.5 mm Ø	01-2591-02
130 mm – 6"	3.0 mm Ø	01-2591-03
130 mm – 6"	4.0 mm Ø	01-2591-04



HARTMANN

1:2

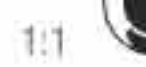
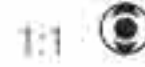
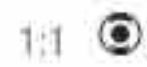
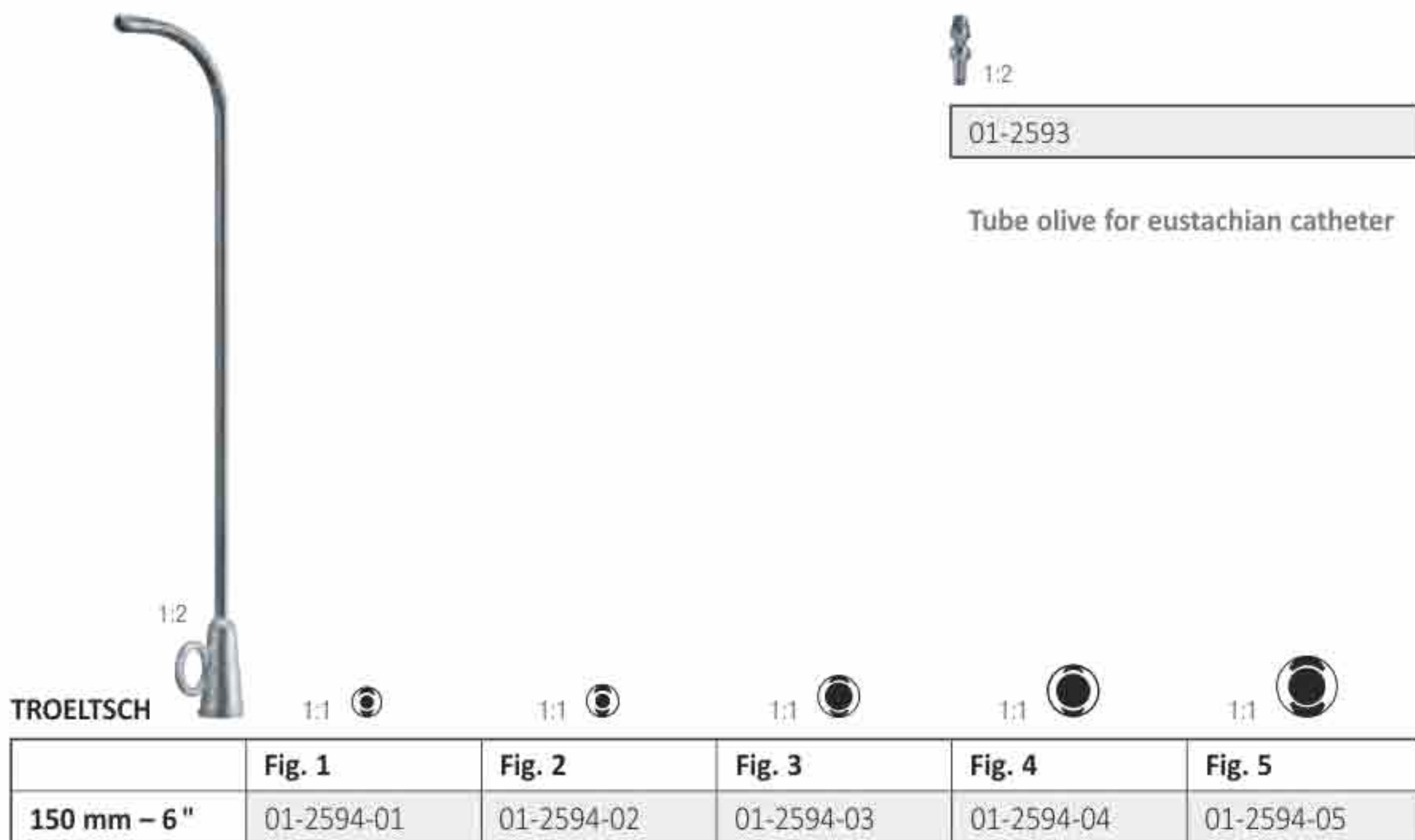

	Fig. 0	Fig. 1	Fig. 2	Fig. 3	Fig. 4	Fig. 5
150 mm – 6"	01-2592-01	01-2592-02	01-2592-03	01-2592-04	01-2592-05	01-2592-06

Eustachian catheters



Ear syringe



50 ccm 2 oz	01-2595-01
75 ccm 3 oz	01-2595-02
100 ccm 4 oz	01-2595-03
150 ccm 6 oz	01-2595-04
200 ccm 8 oz	01-2595-05

1:2



01-2595-06

1:2



01-2595-07



01-2595-08

complete with 2 nozzles

Suction and irrigation cannulae



eicken

2.5 mm Ø	01-2596-01	01-2597-01
3.0 mm Ø	01-2596-02	01-2597-02
4.0 mm Ø	01-2596-03	01-2597-03

slightly curved

strongly curved



**IJer-
IÖck**

3.0 mm Ø
01-2598

**IJer-
IÖck**

2.5 mm Ø
01-2599

FiSch

1.8 mm Ø	01-2600-01
2.5 mm Ø	01-2600-02
3.0 mm Ø	01-2600-03
4.5 mm Ø	01-2600-04

Suction and irrigation cannulae

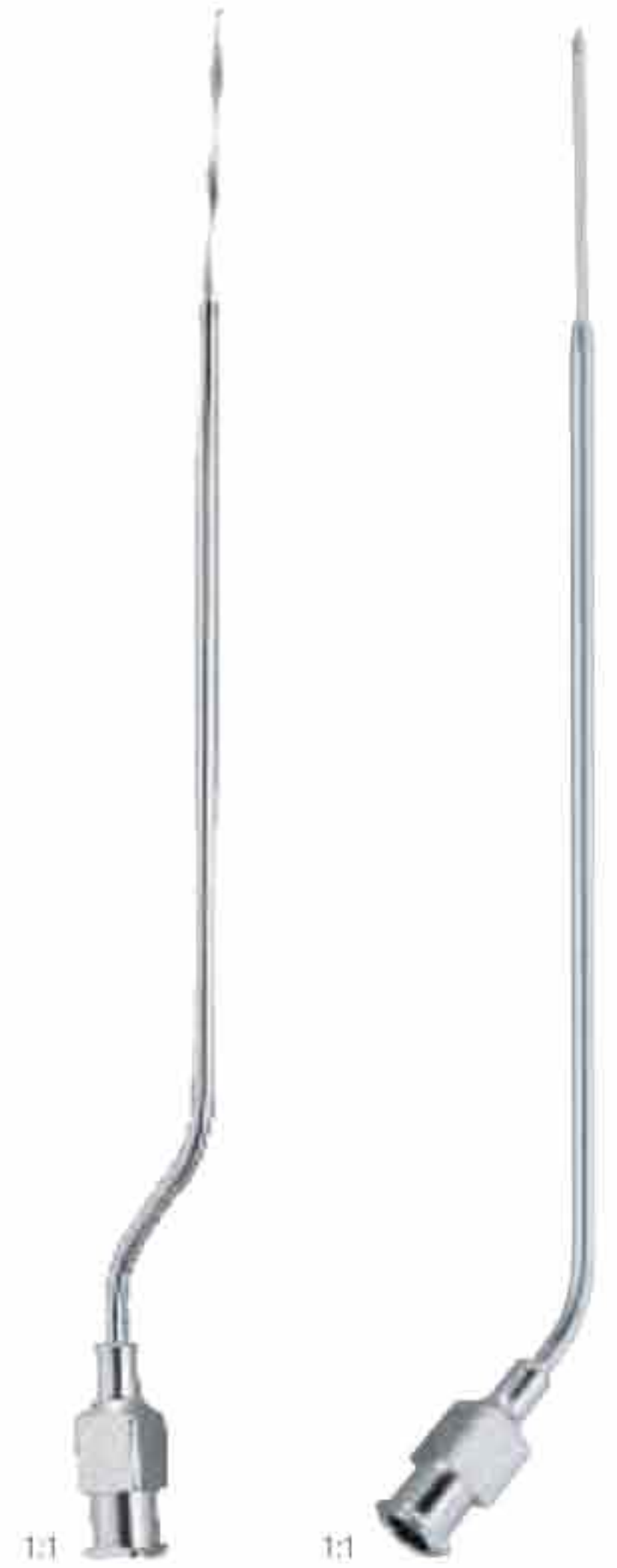
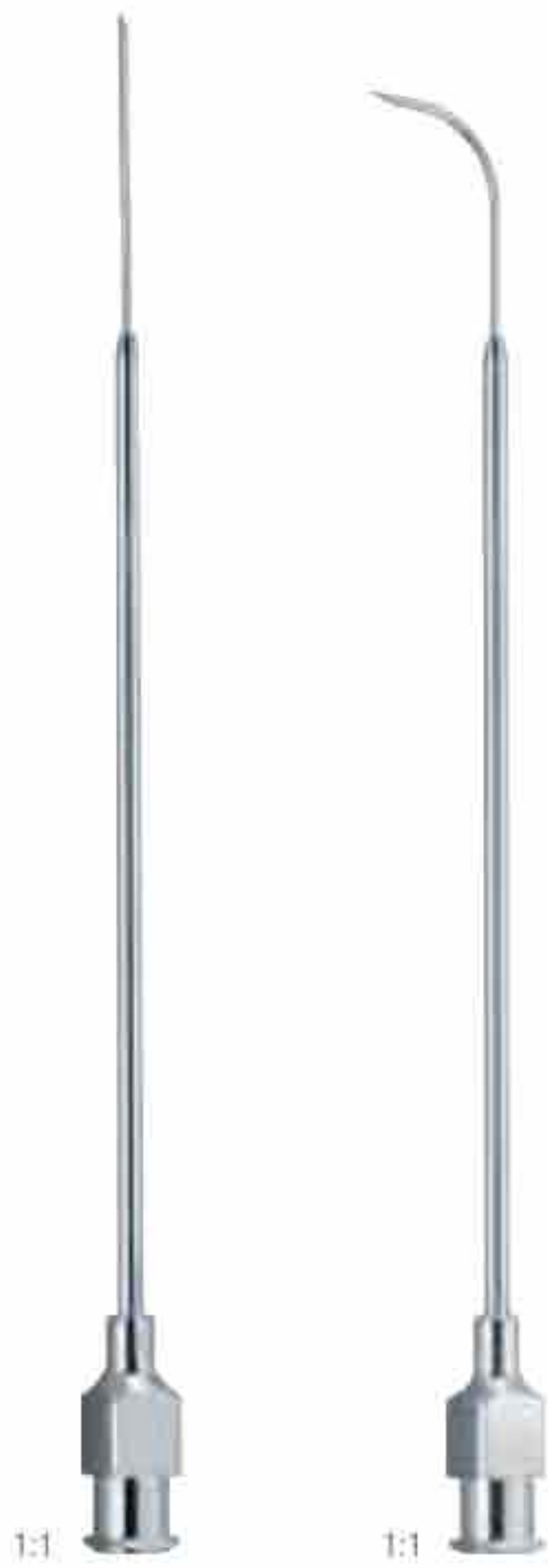

0.8 mm Ø	01-2601-01	01-2601-02
-----------------	------------	------------

0.8 mm Ø	01-2602-01	01-2602-02
-----------------	------------	------------

Tonsil needle

straight

curved

Septum needle

bayonet

angled on flat

Suction tubes



ZÖLLNER

1:2

0.7 mm Ø
01-2603

complete with 1 slip-on cannula, 0.7 mm Ø



MAGILL

	245 mm – 9 ¾ "
3.0 mm Ø	01-2605-01
3.5 mm Ø	01-2605-02
4.0 mm Ø	01-2605-03



IOWA

1:2

	0.7 mm Ø
160 mm – 6 ¼ "	01-2604



ROSEN

1:2

1:2

	x = 80 mm	x = 65 mm
0.5 mm Ø	01-2606-01	01-2607-01
0.6 mm Ø	01-2606-02	01-2607-02
0.7 mm Ø	01-2606-03	01-2607-03
0.9 mm Ø	01-2606-04	01-2607-04
1.0 mm Ø	01-2606-05	01-2607-05
1.2 mm Ø	01-2606-06	01-2607-06
1.4 mm Ø	01-2606-07	01-2607-07
1.5 mm Ø	01-2606-08	01-2607-08
1.8 mm Ø	01-2606-09	01-2607-09
2.0 mm Ø	01-2606-10	01-2607-10
2.5 mm Ø	01-2606-11	01-2607-11
3.0 mm Ø	01-2606-12	01-2607-12

Suction tubes



BARON

		75 mm – 3 "	100 mm – 4 "
1 mm Ø	3 Charr./Fr.	01-2608-01	01-2608-01/L
1 2/3 mm Ø	5 Charr./Fr.	01-2608-02	01-2608-02/L
2 2/3 mm Ø	7 Charr./Fr.	01-2608-03	01-2608-03/L



HOUSE

	90 mm – 3 1/2 "
0.9 x 0.7 mm Ø	01-2609-01
1.2 x 0.9 mm Ø	01-2609-02
1.5 x 1.2 mm Ø	01-2609-03
1.8 x 1.8 mm Ø	01-2609-04
2.5 x 2.0 mm Ø	01-2609-05
3.0 x 2.0 mm Ø	01-2609-06
4.5 x 2.0 mm Ø	01-2609-07



FERGUSON

		170 mm – 6 3/4 "
2 mm Ø	6 Charr./ Fr.	01-2610-01
2 2/3 mm Ø	8 Charr./ Fr.	01-2610-02
3 mm Ø	9 Charr./ Fr.	01-2610-03
3 1/3 mm Ø	10 Charr./ Fr.	01-2610-04
4 mm Ø	12 Charr./ Fr.	01-2610-05
5 mm Ø	15 Charr./ Fr.	01-2610-06

112

Suction tubes



PLESTER

		170 mm – 6 3/4 "
1.6 mm Ø	5 Charr./Fr.	01-2611-01
2 mm Ø	6 Charr./Fr.	01-2611-02
2 1/3 mm Ø	8 Charr./Fr.	01-2611-03
3 mm Ø	9 Charr./Fr.	01-2611-04



FRAZIER

		170 mm – 6 3/4 "
2 mm Ø	6 Charr./ Fr.	01-2612-01
2 1/3 mm Ø	7 Charr./ Fr.	01-2613-01
2 2/3 mm Ø	8 Charr./ Fr.	01-2612-02
3 mm Ø	9 Charr./ Fr.	01-2613-02
3 1/3 mm Ø	10 Charr./ Fr.	01-2612-03
4 mm Ø	12 Charr./ Fr.	01-2612-04
5 mm Ø	15 Charr./ Fr.	01-2613-04



ADSON

		140 mm – 5 1/4 "	210 mm – 8 1/4 "
3 mm Ø	9 Charr./Fr.	01-2614-01	
4 mm Ø	12 Charr. / Fr.		01-2614-02
5 mm Ø	15 Charr. / Fr.		01-2614-03



200 mm – 8 "	01-2615
--------------	---------

Suction raspatory – malleable, sharp

Guide needles



1:1

		195 mm – 5 3/8 "
2 2/3 mm Ø	8 Charr./Fr.	01-2616-01
3 1/3 mm Ø	10 Charr./Fr.	01-2616-02
4 mm Ø	12 Charr./Fr.	01-2616-03
4 2/3 mm Ø	14 Charr./Fr.	01-2616-04
5 1/3 mm Ø	16 Charr./Fr.	01-2616-05
6 mm Ø	18 Charr./Fr.	01-2616-06

1:2



1:1

		195 mm – 5 3/8 "
2 2/3 mm Ø	8 Charr./ Fr.	01-2617-01
3 1/3 mm Ø	10 Charr./ Fr.	01-2617-02
4 mm Ø	12 Charr./ Fr.	01-2617-03
4 2/3 mm Ø	14 Charr./ Fr.	01-2617-04
5 1/3 mm Ø	16 Charr./ Fr.	01-2617-05
6 mm Ø	18 Charr./ Fr.	01-2617-06

1:2



1:1

		195 mm – 5 3/8 "
2 2/3 mm Ø	8 Charr./ Fr.	01-2618-01
3 1/3 mm Ø	10 Charr./ Fr.	01-2618-02
4 mm Ø	12 Charr./ Fr.	01-2618-03
4 2/3 mm Ø	14 Charr./ Fr.	01-2618-04
5 1/3 mm Ø	16 Charr./ Fr.	01-2618-05
6 mm Ø	18 Charr./ Fr.	01-2618-06

1:2

Lancet tip

Hypodermic needles



PRAVAZ (LUER-LOCK)

Fig. 1	0.90 x 38 mm Ø	01-2619-01
Fig. 2	0.80 x 32 mm Ø	01-2619-02
Fig. 12	0.70 x 32 mm Ø	01-2619-03
Fig. 14	0.65 x 28 mm Ø	01-2619-04
Fig. 16	0.60 x 25 mm Ø	01-2619-05
Fig. 18	0.50 x 23 mm Ø	01-2619-06
Fig. 20	0.45 x 20 mm Ø	01-2619-07



Package of 12 pieces

Biopsy needles



QUINKE

0.70 x 50.0 mm Ø	01-2620-01
0.70 x 76.0 mm Ø	01-2620-02
0.70 x 89.0 mm Ø	01-2620-03
1.00 x 76.0 mm Ø	01-2620-04
1.00 x 89.0 mm Ø	01-2620-05
1.20 x 76.0 mm Ø	01-2620-06
1.20 x 89.0 mm Ø	01-2620-07



TUOHY

1.20 x 76.0 mm Ø	01-2621-01
1.40 x 76.0 mm Ø	01-2621-02
1.60 x 76.0 mm Ø	01-2621-03



BIER

1.00 x 80.0 mm Ø	01-2622-01
1.20 x 80.0 mm Ø	01-2622-02
1.50 x 80.0 mm Ø	01-2622-03
1.80 x 80.0 mm Ø	01-2622-04



KLIMA-ROSEGGER

1:2

1.80 x 35.0 mm Ø	01-2623
------------------	---------



VERRES

2.00 x 100 mm Ø	01-2624-01
2.00 x 120 mm Ø	01-2624-02
2.00 x 130 mm Ø	01-2624-03
2.00 x 140 mm Ø	01-2624-04
2.00 x 150 mm Ø	01-2624-05

Biopsy needles



MENGHINI

1.00 x 35.0 mm Ø	01-2625-01
1.00 x 70.0 mm Ø	01-2625-02
1.20 x 70.0 mm Ø	01-2625-03
1.20 x 100.0 mm Ø	01-2625-04
1.40 x 70.0 mm Ø	01-2625-05
1.40 x 100.0 mm Ø	01-2625-06
1.60 x 70.0 mm Ø	01-2625-07
1.80 x 100.0 mm Ø	01-2625-08



MENGHINI

1.40 x 168.0 mm Ø	01-2626-01
1.80 x 168.0 mm Ø	01-2626-02

Percussion Hammers



BABINSKY

220 mm – 8 ¾"	01-2630
---------------	---------



RABINER

230 mm – 9"	01-2631
-------------	---------

Percussion Hammers



WARTENBERG 1:2
 190 mm – 7" 01-2632



BUCK 1:2 1:1
 180 mm – 7" 01-2633



TROEMNER 1:2
 240 mm – 9½" 01-2634

Percussion Hammers



TAYLOR

180 mm – 7"	01-2635-01
200 mm – 8"	01-2635-02



BERLINER

170 mm – 6"	01-2636-01
200 mm – 8"	01-2636-02



DÉJERINE 1:1

1:2

210 mm – 8"	01-2637
--------------------	---------

Measuring instruments



VERNIER

1:2

210 mm – 8 1/4"	01-2638	01-2639
-----------------	---------	---------

Aluminium

Steel



CASTROVIEJO

1:1

80 mm – 3 1/4"	01-2640
----------------	---------

Tongue depressors



WIEDER		
150 mm – 6"	1:2	01-2641-02
140 mm – 5 ½"	01-2641-01	



BOSWOTH	
145 mm – 5 ¾"	01-2642



TOBOLD	
145 mm – 5 ¾"	01-2643



HARTMANN	
150 mm – 6"	01-2644



ANDREW	
110 mm – 4 ¾"	01-2645

Tongue holding forceps



YOUNG

1:2

170 mm – 6 ¾ "	01-2646
-----------------------	---------



1:1

1:1

01-2647

1 Pair rubber-inserts



COLLIN

160 mm – 6 ¼ "	01-2648-01
170 mm – 6 ¾ "	01-2648-02
190 mm – 7 ½ "	01-2648-03

Laryngoscope handles



01-2649

stainless steel



01-2650

stainless steel

Laryngoscopes – Cold light

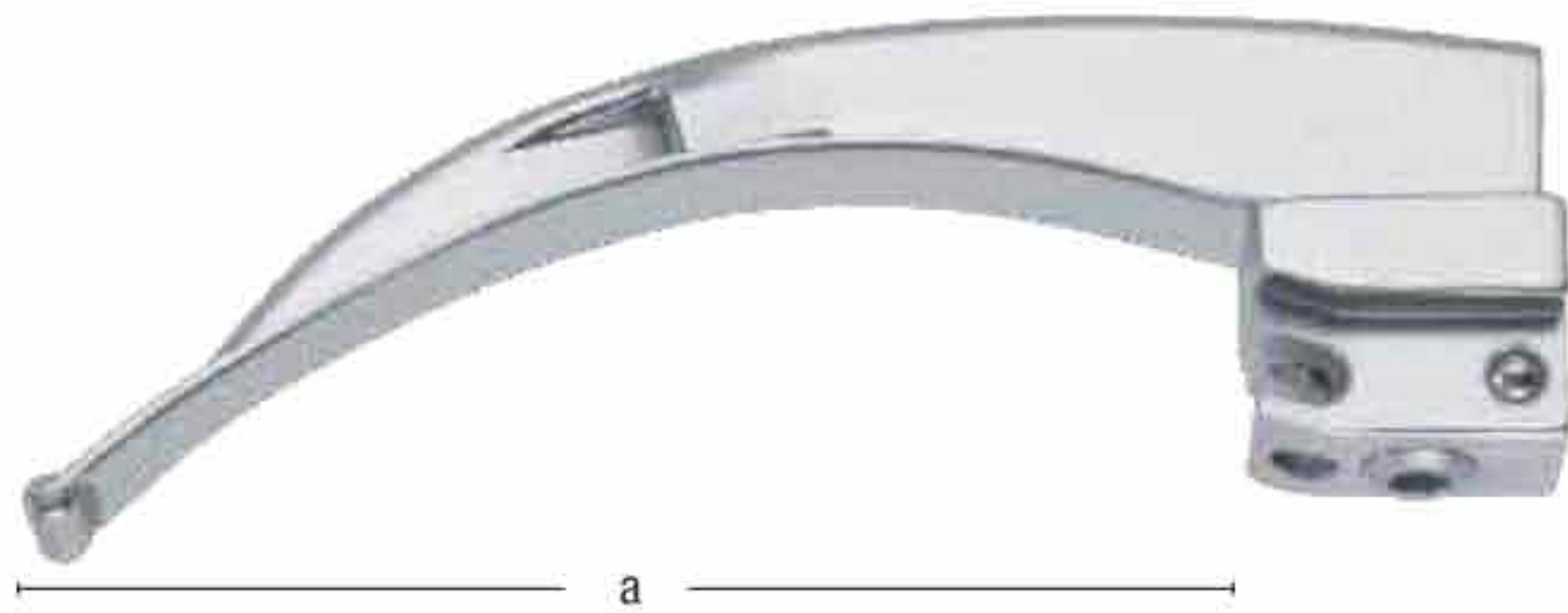

MCINTOSH

Fig. 0	Fig. 1	Fig. 2	Fig. 3	Fig. 4	Fig. 5
a = 55 mm	a = 70 mm	a = 90 mm	a = 110 mm	a = 130 mm	a = 150 mm
01-2651-01	01-2651-02	01-2651-03	01-2651-04	01-2651-05	01-2651-06

stainless steel



	Fig. 0	Fig. 1	Fig. 2	Fig. 3	Fig. 4
	a = 55 mm	a = 70 mm	a = 90 mm	a = 110 mm	a = 130 mm
01-2652			x	x	x
01-2652/1		x	x	x	x
01-2652/2	x	x	x	x	x

Laryngoscopes – Cold light

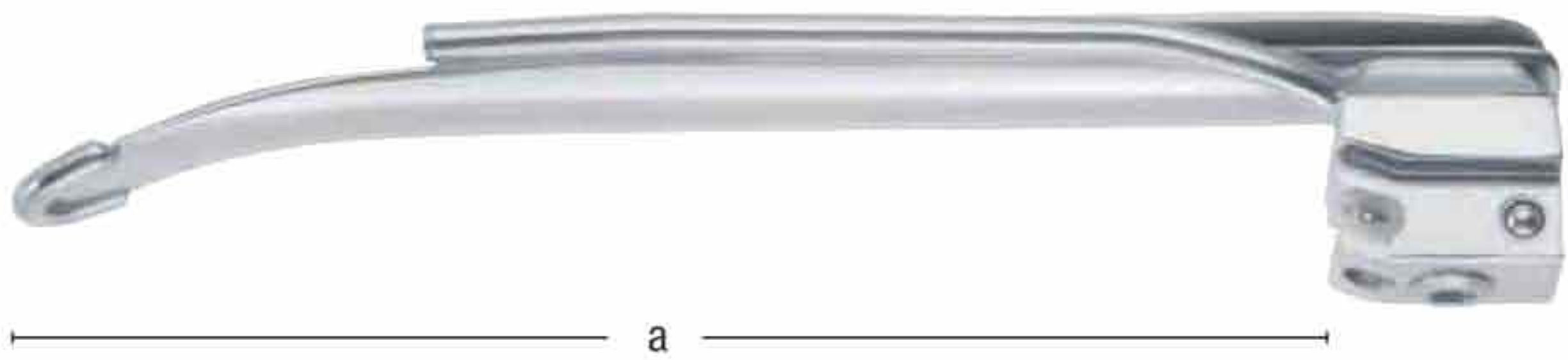

MILLER

Fig. 0	Fig. 1	Fig. 2	Fig. 3	Fig. 4
a = 55 mm	a = 80 mm	a = 130 mm	a = 170 mm	a = 180 mm
01-2653-01	01-2653-02	01-2653-03	01-2653-04	01-2653-05

stainless steel

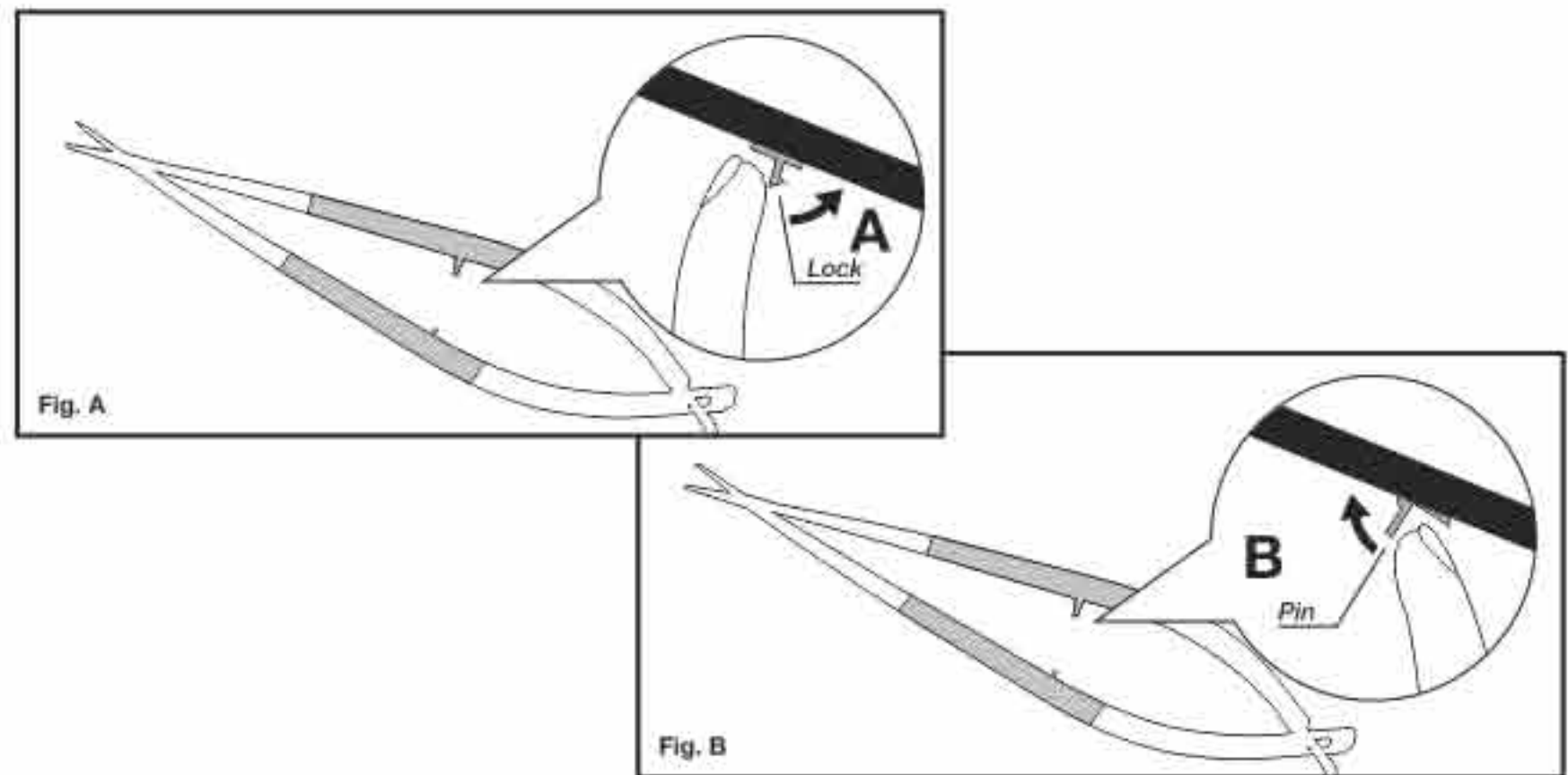

	Fig. 0	Fig. 1	Fig. 2	Fig. 3	Fig. 4
	a = 55 mm	a = 80 mm	a = 130 mm	a = 170 mm	a = 180 mm
01-2654-01			x	x	x
01-2654-02		x	x	x	x
01-2654-03	x	x	x	x	x

Micro needle holders



The 2 in 1 system allows to switch intraoperatively from lock (Fig. A) to lock free (Fig. B) use of the needle holder. In addition to cost effectiveness, this new concept provides better reliability.



Self-retaining brain retractor



01-2660

Brain retractor self-retaining, with 1 flexible arm, complete, consisting of: fixation base for 1 flexible arm, flexible arm only, support for flat brain spatulas

1:2

01-2661

Brain retractor self-retaining, with 2 flexible arms, complete, consisting of: fixation base for 2 flexible arms, 2 flexible arms, 2 supports for flat brain spatulas

Applying forceps for Yasargil clips

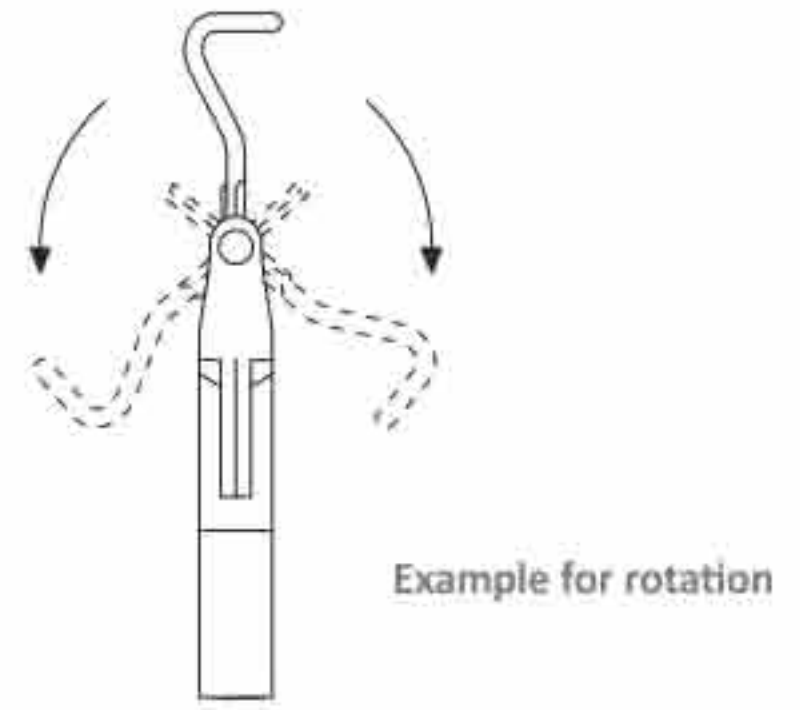
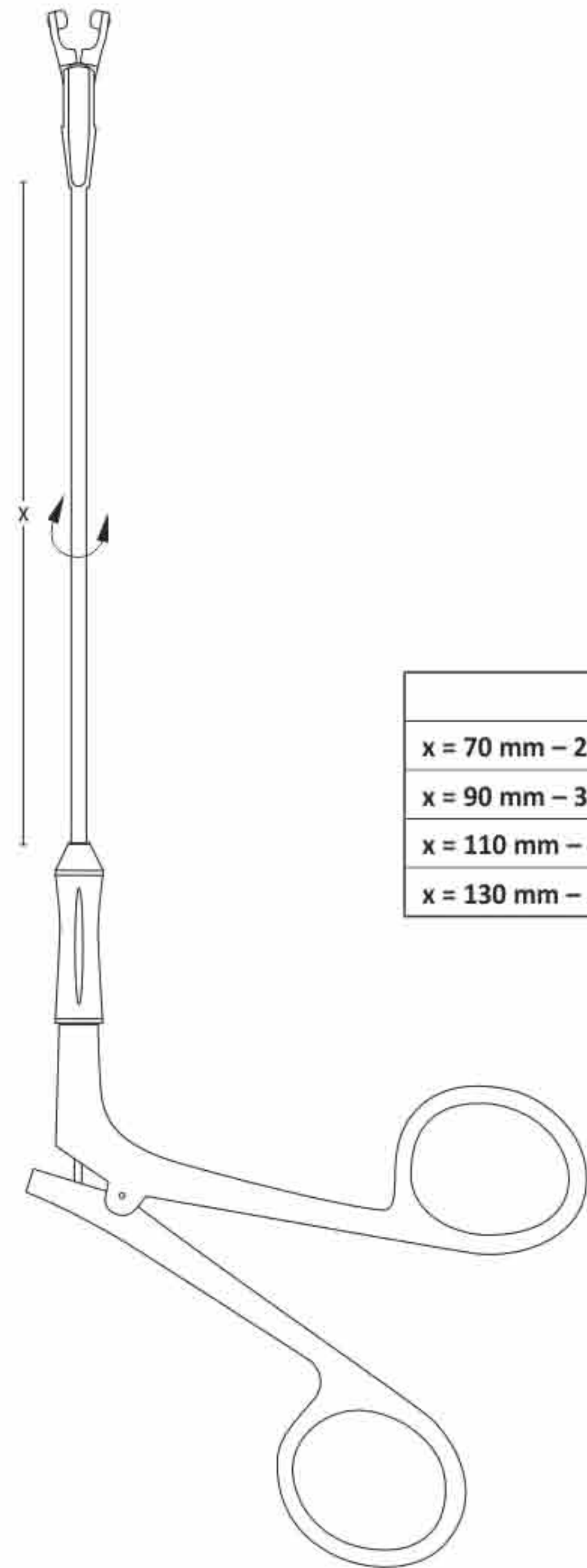

	Mini	Standard
x = 70 mm – 2¾"	01-2662-01	01-2663-01
x = 90 mm – 3½"	01-2662-02	01-2663-02
x = 110 mm – 4¼"	01-2662-03	01-2663-03
x = 130 mm – 5"	01-2662-04	01-2663-04

non rotating

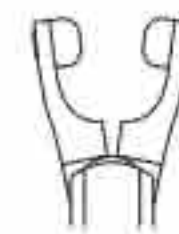

Mini	Standard
01-2662-05	01-2663-05
01-2662-06	01-2663-06
01-2662-07	01-2663-07
01-2662-08	01-2663-08

rotating

Nerve hooks

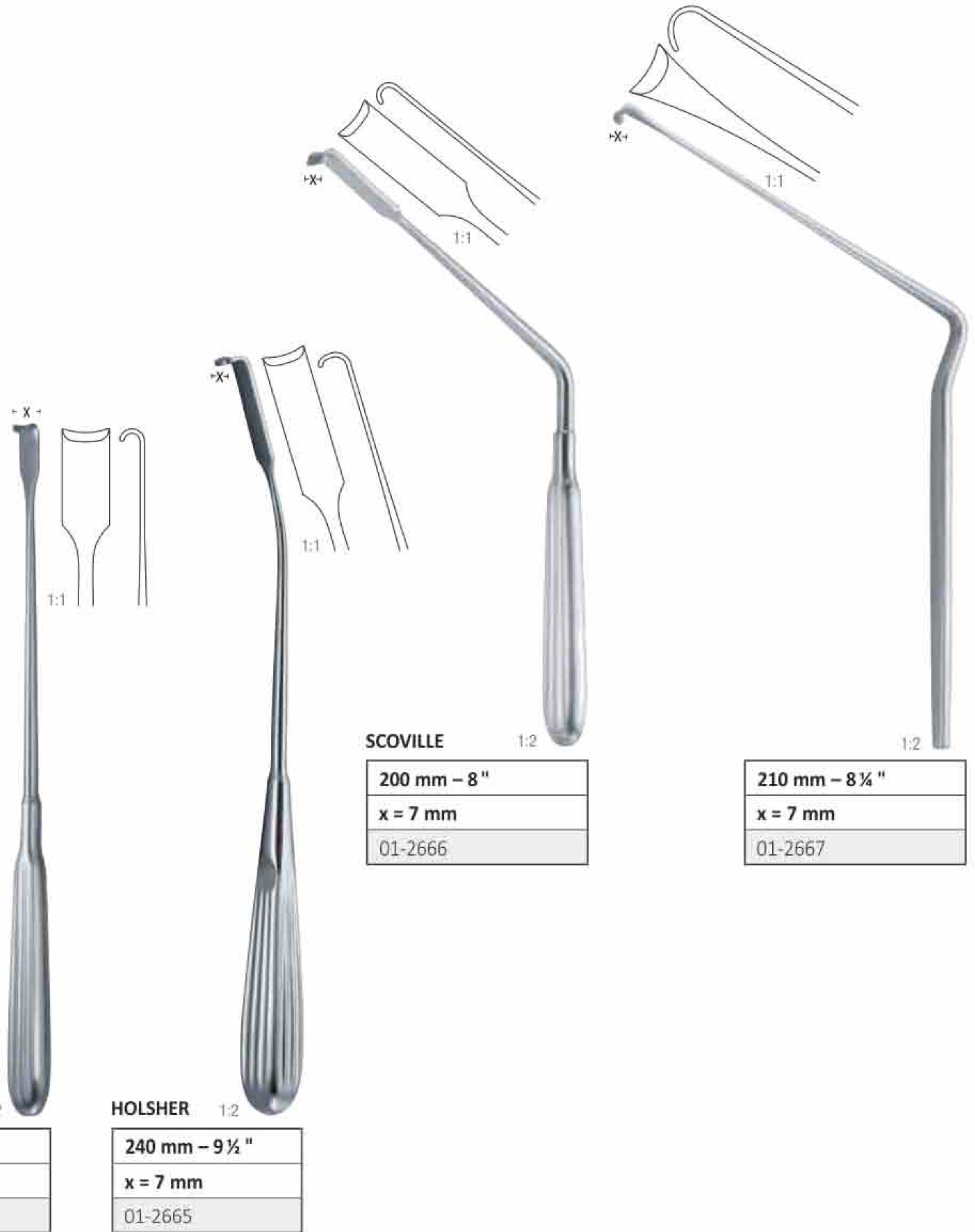

SCOVILLE 1:2

230 mm – 9"
x = 8 mm
01-2664

HOLSHER 1:2

240 mm – 9½"
x = 7 mm
01-2665

SCOVILLE 1:2

200 mm – 8"
x = 7 mm
01-2666

SCOVILLE 1:2

210 mm – 8¼"
x = 7 mm
01-2667

Dura knives



TOENNIS

150 mm – 6"	190 mm – 7 ½"
01-2668-01	01-2668-02



HALLE

200 mm – 8"	01-2669
--------------------	----------------

Nerve hooks – Dura hooks



SMITHWICK

1:1

170 mm – 6 ¾ "	01-2670-01
210 mm – 8 ¼ "	01-2670-02



HOEN

1:2

1:1

220 mm – 8 ¾ "
01-2671



CUSHING

1:1

1:1

190 mm – 7 ½ "	01-2672-01	01-2670-02
280 mm – 11 "	01-2673-01	01-2673-02

Nerve hooks – Dura hooks



SACHS 1:1
185 mm – 7 ¼"
 01-2674

GRAHAM 1:1
165 mm – 6 ½"
 01-2675

FRAZIER 1:1
180 mm – 7"
 01-2676

CRILE 1:1	Fig. 1	Fig. 2
	200 mm – 8"	200 mm – 8"
	01-2677	01-2678

TOENNIS 1:2
150 mm – 6"
 01-2679

DANDY 1:2 1:2 1:2
200 mm – 8" 01-2680-01 01-2680-02 01-2680-03

ADSON 1:2 1:1 1:1
200 mm – 8" 01-2681-01 01-2681-02

Nerve hooks – Dura hooks



LOVE	1:2		
190 mm – 7 ½ "	01-2682-01	01-2682-02	01-2682-03

YASARGIL	
310 mm – 12 ¼ "	01-2683-01
410 mm – 16 ¼ "	01-2683-02

Galea retractor



CUSHING	1:1
140 mm – 5 ½ "	01-2684



FRAZIER	1:1	1:1
130 mm – 5 "	01-2685-01	01-2686-01
180 mm – 7 "	01-2685-02	01-2686-02

sharp

blunt



LAHEY	1:1
130 mm – 5 "	01-2687

Dura dissectors



Dura dissectors

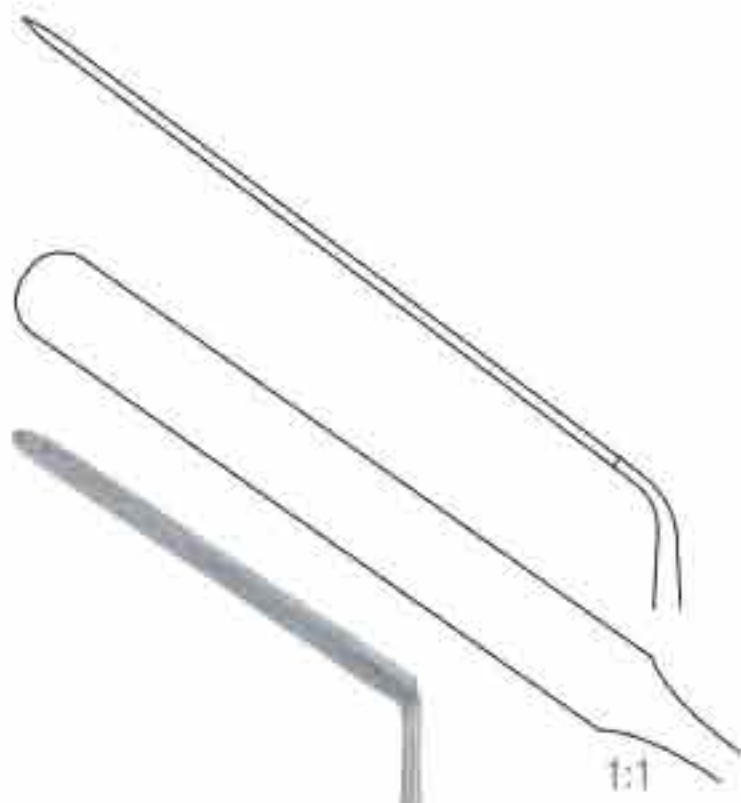

1:1

HORSLEY

200 mm – 8"
01-2691

1:2



1:1

SMITHWICK

290 mm – 11 1/2"
01-2692

1:2

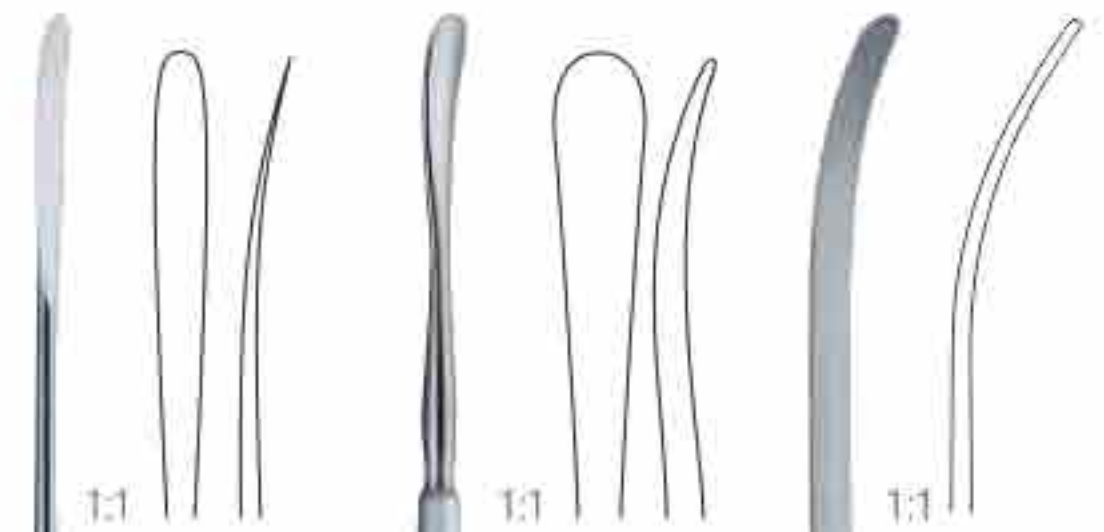

1:1

1:1

1:1

SACHS

210 mm – 8 1/4"	01-2693	01-2694	01-2695
-----------------	---------	---------	---------

1:2

1:2

1:2



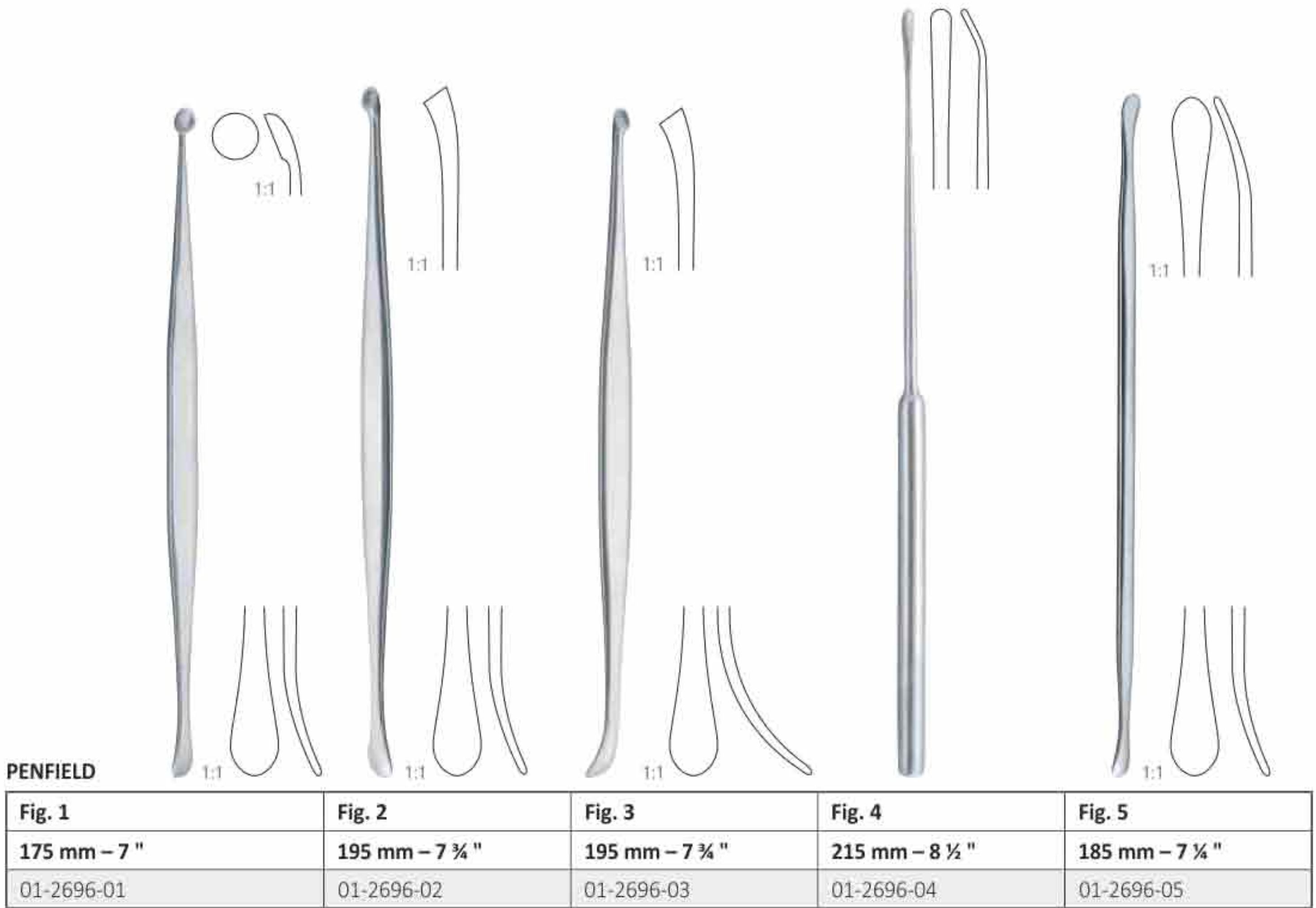

Dura dissectors



Neuro-micro dissectors

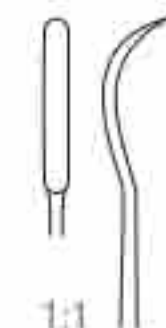

YASARGIL



1:1		1:1		1:1		1:1		1:1	
190 mm – 7 ½ "	01-2697-01	01-2697-02	01-2697-03	01-2697-04	01-2697-05				

straight

190 mm – 7 ½ "	01-2698-01	01-2698-02	01-2698-03	01-2698-04	01-2698-05
-----------------------	------------	------------	------------	------------	------------

bayonet

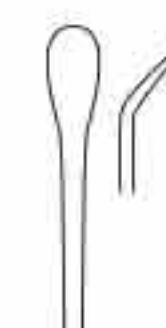
YASARGIL

1:1		1:1		1:1		1:1	
190 mm – 7 ½ "	01-2699-01	01-2699-02	01-2699-03	01-2699-04			

straight

190 mm – 7 ½ "	01-2700-01	01-2700-02	01-2700-03	01-2700-04
-----------------------	------------	------------	------------	------------

bayonet

1:1		1:1	
190 mm – 7 ½ "	01-2701-01	01-2701-02	

straight, with Twist-fixationhook

Neuro-micro dissectors



1:1

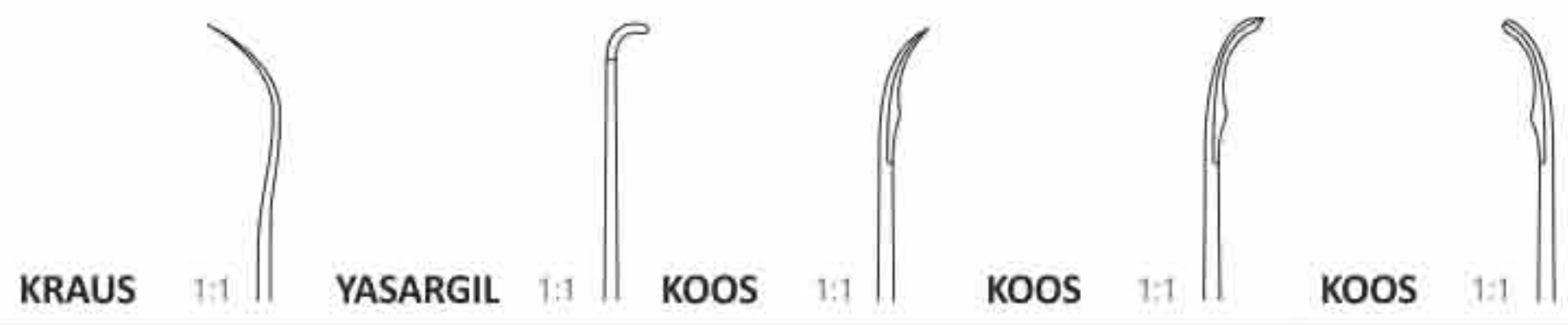

	KRAUS 1:1	YASARGIL 1:1	KOOS 1:1	KOOS 1:1	KOOS 1:1
190 mm – 7 ½ "	01-2702-01	01-2702-02	01-2702-03	01-2702-04	01-2702-05

bayonet

Neuro-micro dissectors

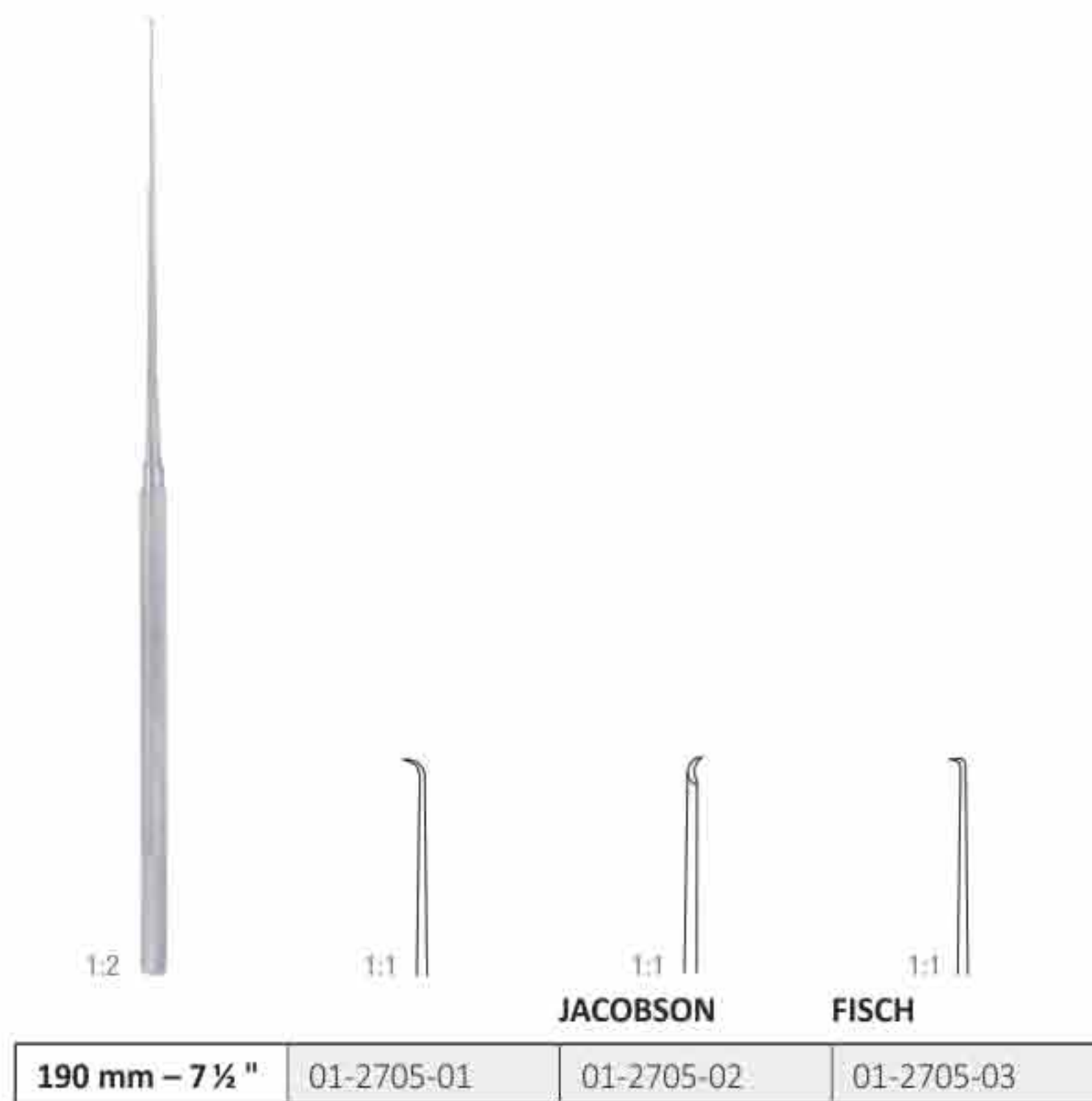
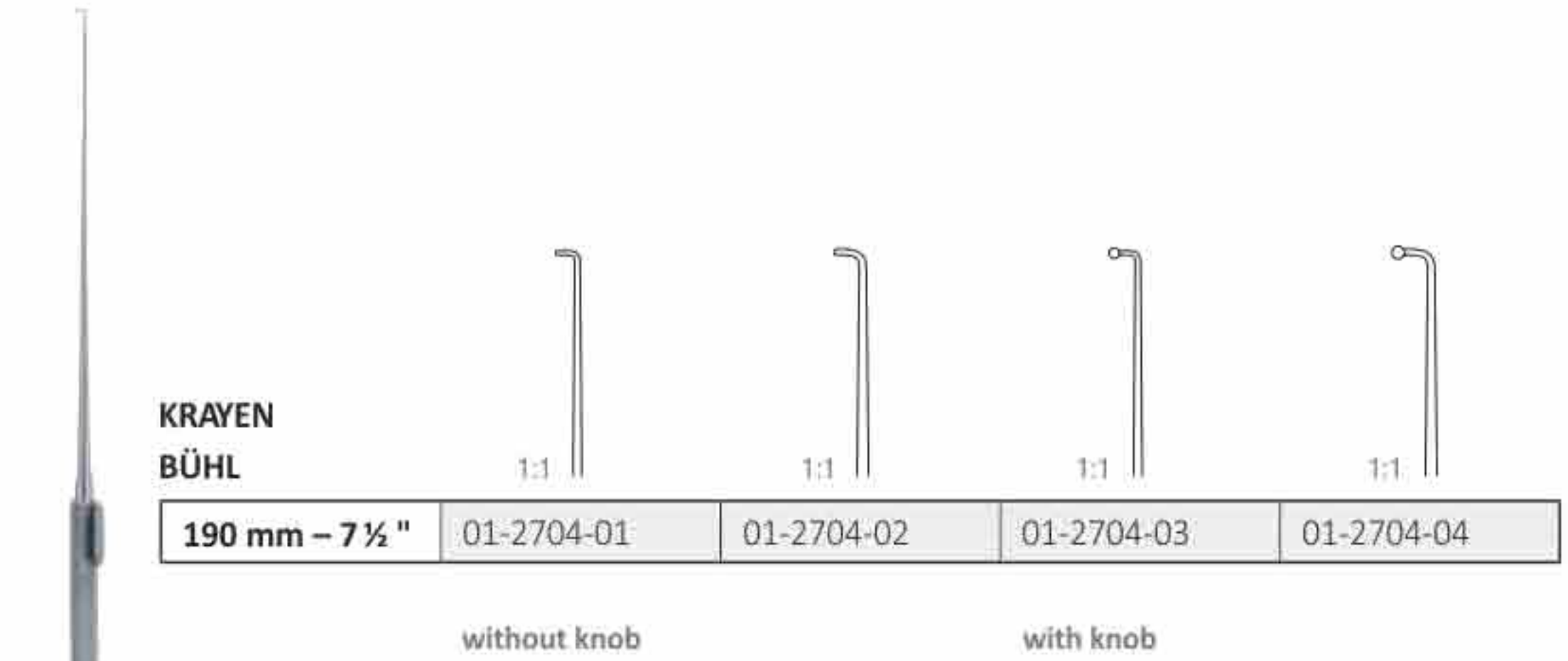

Neuro dissectors and curettes



HARDY

1:2

1:2

1:2

1:2

250 mm – 9 3/4 "	01-2706-01	01-2706-02	01-2706-03	01-2706-04
-------------------------	------------	------------	------------	------------

bayonet, sharp inner edge



HARDY

1:2

1:2

	4 mm Ø	6 mm Ø
270 mm – 10 3/4 "	01-2707-01	01-2707-08

bayonet, malleable

Micro scissors



VANNAS

80 mm – 3 ¼ "

1:1



1:1



01-2708

01-2709

Vannas-blade

Micro scissors



120 mm – 4 3/4 "	01-2710-01	01-2710-02
-------------------------	------------	------------

Blade 10 mm, sharp straight curved



120 mm – 4 3/4 "	01-2711-01	01-2711-02	01-2711-03
-------------------------	------------	------------	------------

Vannas blade straight curved angled up



BIEMER

120 mm – 4 3/4 "	01-2712
-------------------------	---------

Vein blade straight

Micro scissors



160 mm – 6 1/3 "	01-2713	01-2714	01-2715	01-2716
-------------------------	---------	---------	---------	---------

curved, short blades

straight, long blades

straight, long blades

curved, long blades



160 mm – 6 1/3 "	01-2717	01-2718
-------------------------	---------	---------

straight, saw edge

curved, saw edge



150 mm – 6 "	01-2719-01
180 mm – 7 "	01-2719-02

angled on flat, 45°

Micro scissors

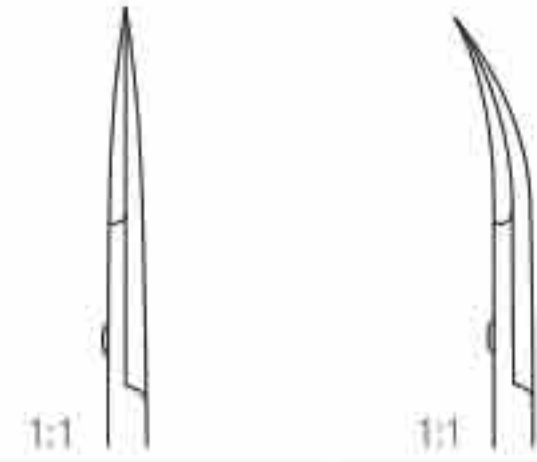

120 mm – 4 ¾ "	01-2720-01	01-2720-02
-----------------------	------------	------------

Long blades 14 mm, smooth, sharp straight curved

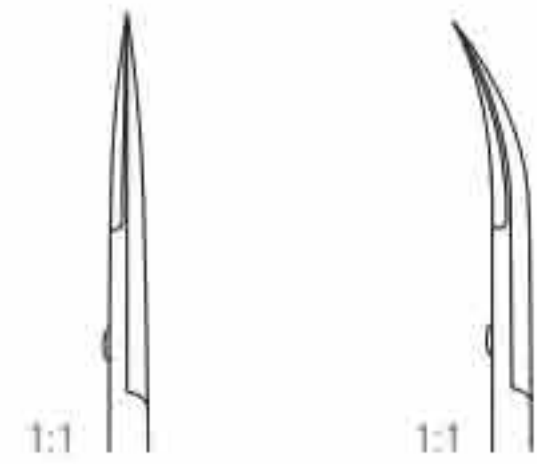

120 mm – 4 ¾ "	01-2720-03	01-2720-04
-----------------------	------------	------------

Long blades 14 mm, sharp straight, saw edge curved, saw edge

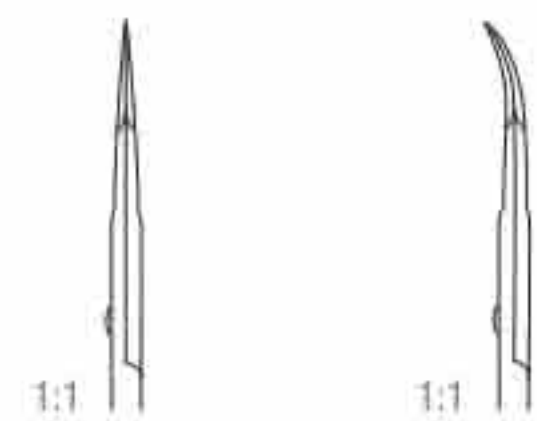

145 mm – 5 ¾ "	01-2721-01	01-2721-02
-----------------------	------------	------------

Vannas-blades, smooth, sharp straight curved

Micro scissors



YASARGIL

185 mm – 7 ¼"	01-2722-01	01-2722-02	01-2722-03
---------------	------------	------------	------------

straight

curved

angled on flat

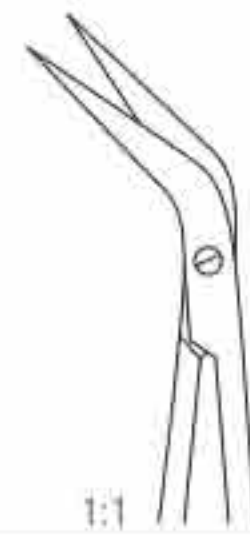

Micro scissors



1:1

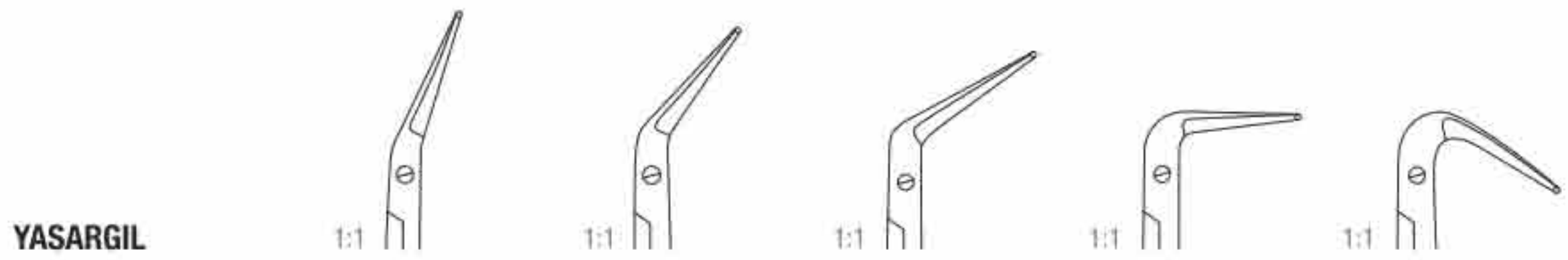

YASARGIL

	25°	45°	60°	90°	125°
170 mm – 6 3/4 "	01-2723-01	01-2723-02	01-2723-03	01-2723-04	01-2723-05

with ball

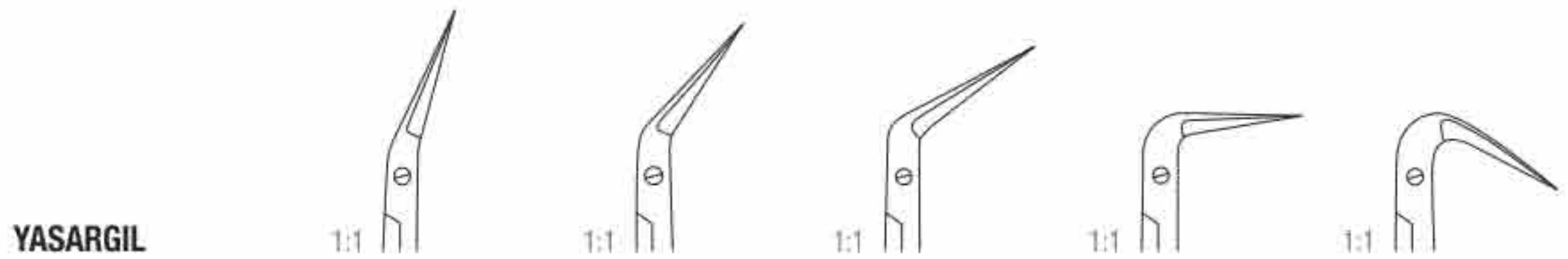

YASARGIL

	25°	45°	60°	90°	125°
170 mm – 6 3/4 "	01-2723-06	01-2723-07	01-2723-08	01-2723-09	01-2723-10

without ball

Micro dissecting scissors



145 mm – 5 ¾ "	01-2724-01	01-2725-01	01-2726-01	01-2727-01
180 mm – 7 "	01-2724-02	01-2725-02	01-2726-02	01-2727-02

short blades 8 mm, smooth straight, sharp curved, sharp straight, blunt curved, blunt

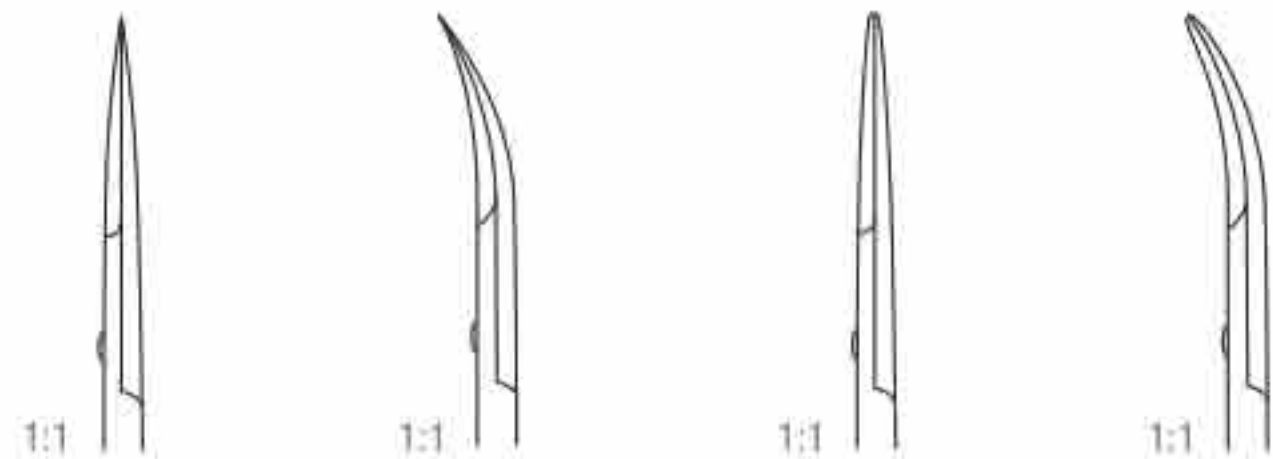

145 mm – 5 ¾ "	01-2724-01L	01-2725-01L	01-2726-01L	01-2727-01L
180 mm – 7 "	01-2724-02L	01-2725-02L	01-2726-02L	01-2727-02L

long blades 14 mm, smooth straight, sharp curved, sharp straight, blunt curved, blunt

Micro scissors with round handle



VANNAS

1:1



1:1



	7 mm Ø	7 mm Ø
120 mm – 5"	01-2728-01	01-2728-02

VANNAS

1:1



1:1



	8 mm Ø	8 mm Ø
150 mm – 6"	01-2729-01	01-2729-02

CASTROVIEJO

1:1



1:1



	8 mm Ø	8 mm Ø
150 mm – 6"	01-2730-01	01-2730-02

Micro scissors with round handle

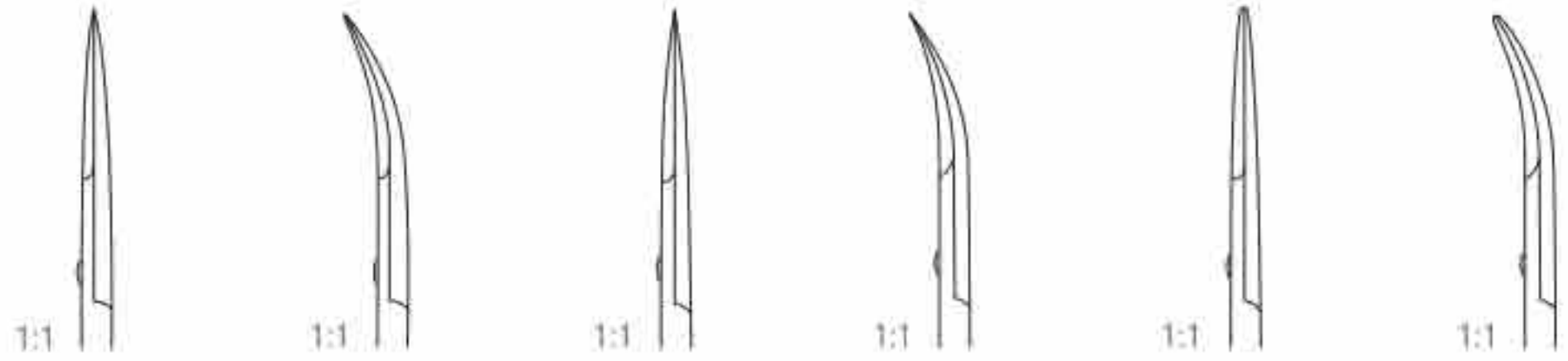

	180 mm - 7"	180 mm - 7"	180 mm - 7"	180 mm - 7"	180 mm - 7"	180 mm - 7"
10 mm Ø	01-2731-01	01-2731-02	01-2731-03	01-2731-04	01-2731-05	01-2731-06

straight, saw edge curved, saw edge straight, sharp curved, sharp straight, blunt curved, blunt

Micro scissors with round handle



1:1



8 mm Ø	25°	45°	60°	90°	125°
180 mm – 7"	01-2732-01	01-2732-02	01-2732-03	01-2732-04	01-2732-05

Blade 10 mm, with ball, sharp



8 mm Ø	25°	45°	60°	90°	125°
180 mm – 7"	01-2733-01	01-2733-02	01-2733-03	01-2733-04	01-2733-05

Blade 10 mm, without ball, sharp

Micro scissors with round handle



8 mm Ø	25°	45°	60°	90°	125°
180 mm – 7"	01-2734-01	01-2734-02	01-2734-03	01-2734-04	01-2734-05

with ball



8 mm Ø	25°	45°	60°	90°	125°
180 mm – 7"	01-2735-01	01-2735-02	01-2735-03	01-2735-04	01-2735-05

without ball

Micro scissors with round handle



	9 mm Ø	9 mm Ø
150 mm – 6"	01-2736-01	01-2736-02

Micro scissors



JACOBSON



160 mm – 6 ¼ "	01-2737-01	01-2738-01	01-2739-01
180 mm – 7 "	01-2737-02	01-2738-02	01-2739-02

straight

curved

angled, 45°



160 mm – 6 ¼ "	01-2740-01	01-2741-01
180 mm – 7 "	01-2740-02	01-2741-02

Vannas blade

Micro scissors



**YASARGIL-
MOD.**

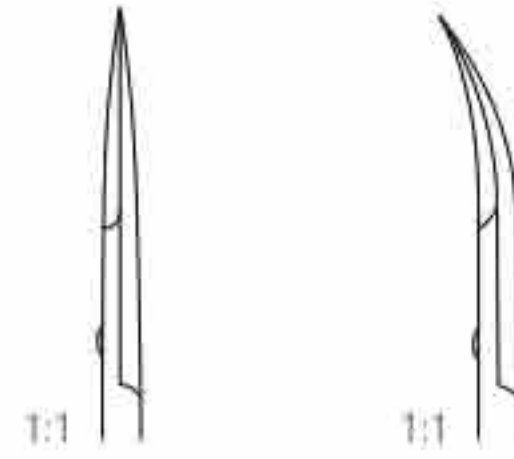

180 mm – 7"	01-2742-01	01-2742-02
225 mm – 8 ¼"	01-2743-01	01-2743-02



220 mm – 8 ¾"	01-2744-01	01-2744-02
----------------------	------------	------------

Vannas blade

Fixation forceps – Vascular dilators



TYP

JUWELIER

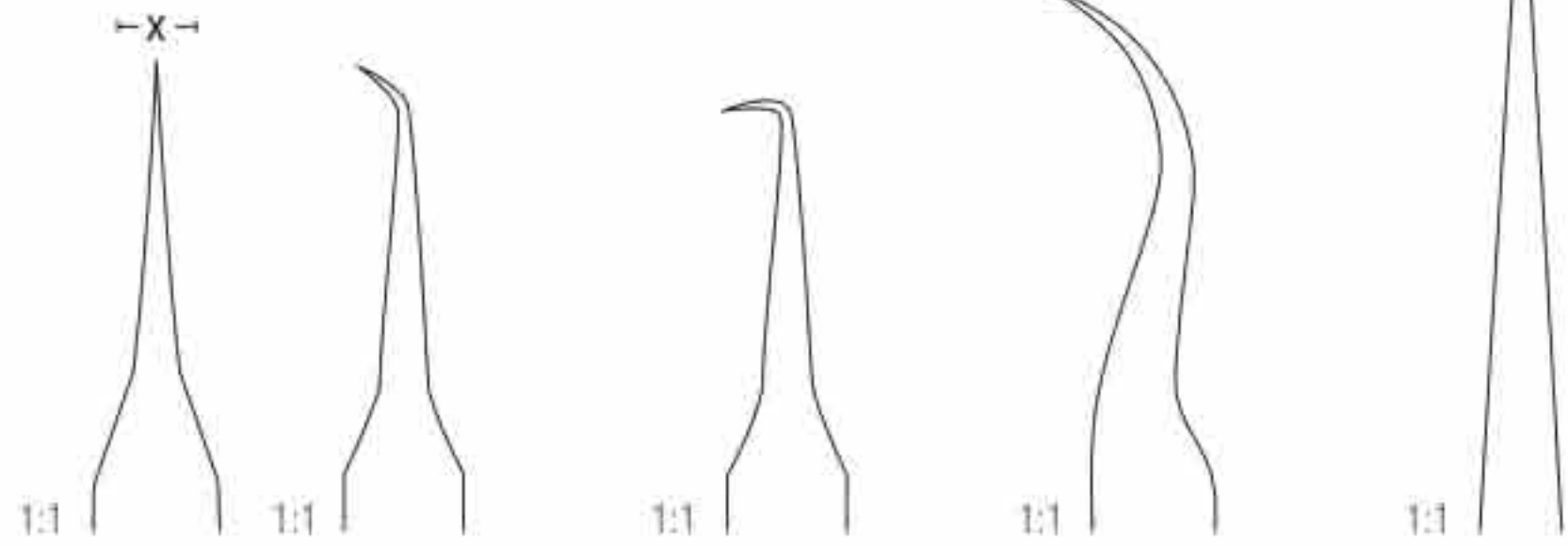

x = 0.2 mm	x = 0.3 mm	x = 0.3 mm	x = 0.2 mm	x = 0.3 mm
110 mm – 4 ¼ "	110 mm – 4 ¼ "	110 mm – 4 ¼ "	120 mm – 4 ¼ "	120 mm – 4 ¼ "
08-962-004	01-2745-01	01-2745-02	01-2745-03	01-2745-04

titan	titan	titan
x = 0.2 mm	x = 0.3 mm	x = 0.3 mm
110 mm – 4 ¼ "	110 mm – 4 ¼ "	110 mm – 4 ¼ "
01-2745-05	01-2745-06	01-2745-07



PIERSE

1:1

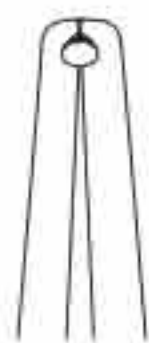

120 mm – 4 ¼ "	01-2746-01
135 mm – 5 ¼ "	01-2746-02



1:1

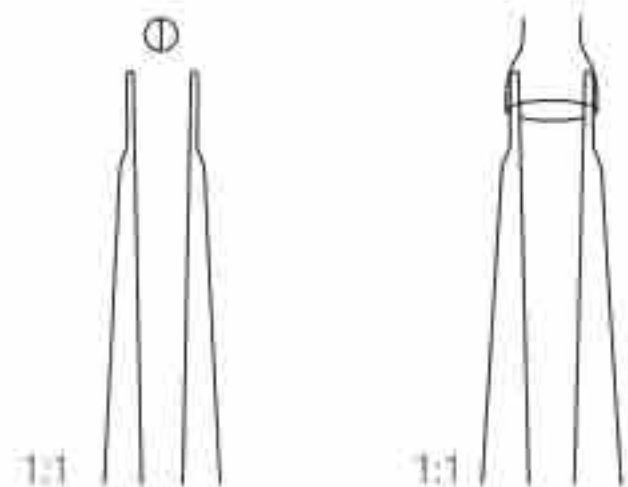

	x = 0.2 mm	x = 0.3 mm
110 mm – 4 ¼ "	01-2747-01	01-2747-02

very fine

Micro suture tying forceps

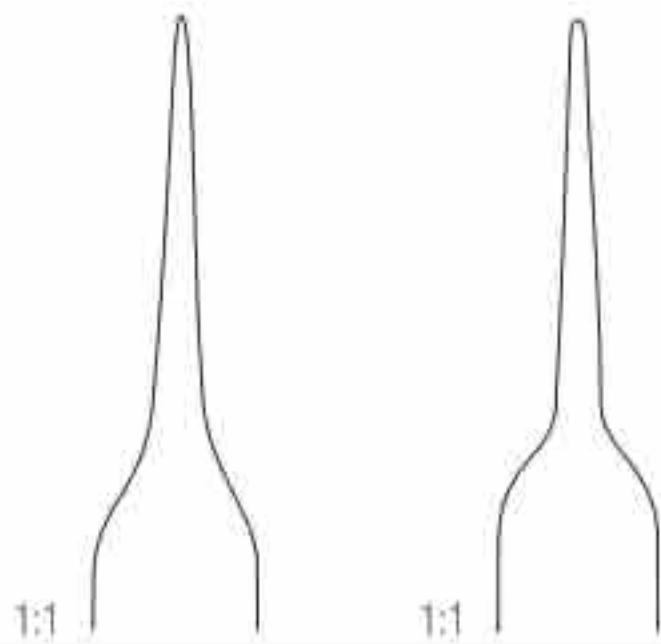

LAZAR

	0.5 mm	0.8 mm
155 mm – 6"	01-2748-01	01-2748-02

Micro forceps



8 mm Ø	0.3 mm	0.3 mm	0.3 mm	0.3 mm
120 mm – 4 ¾ "	01-2749-01	01-2749-02		
150 mm – 6 "	01-2750-01	01-2750-02	01-2750-03Z	01-2750-04Z
180 mm – 7 "	01-2751-01	01-2751-02	01-2751-03Z	01-2751-04Z
210 mm – 8 ¼ "	01-2752-01	01-2752-02	01-2752-03Z	01-2752-04Z
230 mm – 9 "	01-2753-01	01-2753-02	01-2753-03Z	01-2753-04Z

1 x 2

1 x 2

Tying platform 6.0 mm x 0.3 mm, smooth

	titan	titan	titan	titan
8 mm Ø	0.3 mm	0.3 mm	0.3 mm	0.3 mm
150 mm – 6 "	01-2754-01T	01-2754-02T	01-2754-03ZT	01-2754-04ZT
180 mm – 7 "	01-2755-01T	01-2755-02T	01-2755-03ZT	01-2755-04ZT
210 mm – 8 ¼ "	01-2756-01T	01-2756-02T	01-2756-03ZT	01-2756-04ZT

1 x 2

1 x 2

Tying platform 6.0 mm x 0.3 mm, smooth



8 mm Ø	0.7 mm	0.7 mm	0.7 mm	0.7 mm
150 mm – 6 "	01-2757-01	01-2757-02	01-2757-03Z	01-2757-04Z
180 mm – 7 "	01-2758-01	01-2758-02	01-2758-03Z	01-2758-04Z
210 mm – 8 ¼ "	01-2759-01	01-2759-02	01-2759-03Z	01-2759-04Z
230 mm – 9 "	01-2760-01	01-2760-02	01-2760-03Z	01-2760-04Z

1 x 2

1 x 2

Tying platform 6.0 mm x 0.7 mm, smooth

	titan	titan	titan	titan
8 mm Ø	0.7 mm	0.7 mm	0.7 mm	0.7 mm
150 mm – 6 "	01-2757-01T	01-2757-02T	01-2757-03ZT	01-2757-04ZT
180 mm – 7 "	01-2758-01T	01-2758-02T	01-2758-03ZT	01-2758-04ZT
210 mm – 8 ¼ "	01-2759-01T	01-2759-02T	01-2759-03ZT	01-2759-04ZT

1 x 2

1 x 2

Tying platform 6.0 mm x 0.7 mm, smooth

Micro forceps



	diamond Coated	diamond Coated	diamond Coated	diamond Coated
8 mm Ø	0.3 mm	0.3 mm	0.3 mm	0.3 mm
150 mm – 6"	01-2760-01D	01-2761-01D	01-2762-01ZD	01-2763-01ZD
180 mm – 7"	01-2760-02D	01-2761-02D	01-2762-02ZD	01-2763-02ZD
210 mm – 8 ¼"	01-2760-03D	01-2761-03D	01-2762-03ZD	01-2763-03ZD
230 mm – 9"	01-2760-04D	01-2761-04D	01-2762-04ZD	01-2763-04ZD

1 x 2

1 x 2

Tying platform 6.0 mm x 0.3 mm



	diamond Coated	diamond Coated	diamond Coated	diamond Coated
8 mm Ø	0.7 mm	0.7 mm	0.7 mm	0.7 mm
150 mm – 6"	01-2764-01D	01-2765-01D	01-2766-01ZD	01-2767-01ZD
180 mm – 7"	01-2764-02D	01-2765-02D	01-2766-02ZD	01-2767-02ZD
210 mm – 8 ¼"	01-2764-03D	01-2765-03D	01-2766-03ZD	01-2767-03ZD
230 mm – 9"	01-2764-04D	01-2765-04D	01-2766-04ZD	01-2767-04ZD

1 x 2

1 x 2

Tying platform 6.0 mm x 0.7 mm

Micro forceps



JACOBSON



160 mm – 6 ¼ "	01-2768-01	01-2769-01	01-2770-01	01-2771-01
185 mm – 7 ¼ "	01-2768-02	01-2769-02	01-2770-02	01-2771-02

straight, sharp

straight, blunt

angled, sharp

angled, blunt

	diamond Coated	diamond Coated	diamond Coated	diamond Coated
160 mm – 6 ¼ "	01-2768-01D	01-2769-01D	01-2770-01D	01-2771-01D
185 mm – 7 ¼ "	01-2768-02D	01-2769-02D	01-2770-02D	01-2771-02D

straight, sharp

straight, blunt

angled, sharp

angled, blunt

Micro forceps



YASARGIL

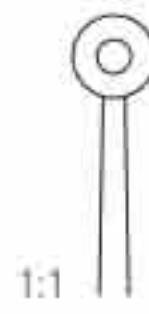

	225 mm – 8 ¾ "	225 mm – 8 ¾ "	225 mm – 8 ¾ "
3.0 mm	01-2772-01	01-2773-01	01-2774-01
5.0 mm	01-2772-02	01-2773-02	01-2774-02

spoon form

plan toothed

curette form

Micro forceps



YASARGIL

160 mm – 1 $\frac{1}{3}$ "	01-2775-01	01-2776-01
180 mm – 1 $\frac{1}{2}$ "	01-2775-02	01-2776-02
200 mm – 8"	01-2775-03	01-2776-03
225 mm – 8 $\frac{3}{4}$ "	01-2775-04	01-2776-04
240 mm – 9 $\frac{1}{2}$ "	01-2775-05	01-2776-05

straight, sharp

straight, blunt

Micro ring forceps



			diamond Coated	diamond Coated
9 mm Ø	1.0 x 0.5 mm	2.0 x 1.0 mm	1.0 x 0.5 mm	2.0 x 1.0 mm
150 mm – 6"	01-2777-01	01-2778-01	01-2779-01D	01-2780-01D
180 mm – 7"	01-2777-02	01-2778-02	01-2779-02D	01-2780-02D
210 mm – 8 ¼"	01-2777-03	01-2778-03	01-2779-03D	01-2780-03D
230 mm – 9"	01-2777-04	01-2778-04	01-2779-04D	01-2780-04D

smooth

smooth



	titan	titan	titan / diamond Coated	titan / diamond Coated
9 mm Ø	1.0 x 0.5 mm	2.0 x 1.0 mm	1.0 x 0.5 mm	2.0 x 1.0 mm
150 mm – 6"	01-2777-01T	01-2778-01T	01-2779-01DT	01-2780-01DT
180 mm – 7"	01-2777-02T	01-2778-02T	01-2779-02DT	01-2780-02DT
210 mm – 8 ¼"	01-2777-03T	01-2778-03T	01-2779-03DT	01-2780-03DT
230 mm – 9"	01-2777-04T	01-2778-04T	01-2779-04DT	01-2780-04DT

smooth

smooth

Atraumatic micro forceps



	atrauma	atrauma	atrauma	atrauma
	x = 1.2 mm	x = 1.8 mm	x = 1.2 mm	x = 1.8 mm
150 mm – 6"	01-2781-01	01-2782-01	01-2783-01	01-2784-01
180 mm – 7"	01-2781-02	01-2782-02	01-2783-02	01-2784-02
210 mm – 8 ¼"	01-2781-03	01-2782-03	01-2783-03	01-2784-03
230 mm – 9"	01-2781-04	01-2782-04	01-2783-04	01-2784-04

straight

straight

angled

angled



	titan	titan	titan	titan
	x = 1.2 mm	x = 1.8 mm	x = 1.2 mm	x = 1.8 mm
150 mm – 6"	01-2781-01T	01-2782-01T	01-2783-01T	01-2784-01T
180 mm – 7"	01-2781-02T	01-2782-02T	01-2783-02T	01-2784-02T
210 mm – 8 ¼"	01-2781-03T	01-2782-03T	01-2783-03T	01-2784-03T
230 mm – 9"	01-2781-04T	01-2782-04T	01-2783-04T	01-2784-04T

straight

straight

angled

angled

Micro needle holders



CASTROVIEJO

			DIAMOND COATED	DIAMOND COATED
x = 11.0 mm x 0.75 mm				
140 mm – 5 ½"	01-2785-01	01-2785-02	01-2785-01D	01-2785-02D

without ratchet, fine jaws straight curved straight curved

			DIAMOND COATED	DIAMOND COATED
x = 11.0 mm x 0.75 mm				
140 mm – 5 ½"	01-2786-01	01-2786-02	01-2786-01D	01-2786-02D

with ratchet, fine jaws straight curved straight curved

Micro needle holders



JACOBSON

			diamond Coated	diamond Coated
	x = 1 mm	x = 1 mm	x = 1 mm	x = 1 mm
185 mm – 7 1/3"	01-2787-01	01-2787-02	01-2787-01D	01-2787-02D

without ratchet straight curved straight curved

			diamond Coated	diamond Coated
	x = 1 mm	x = 1 mm	x = 1 mm	x = 1 mm
185 mm – 7 1/3"	01-2788-01	01-2788-02	01-2788-01D	01-2788-02D

with ratchet straight curved straight curved



	T.C	T.C	T.C	T.C
	x = 1 mm	x = 1 mm	x = 1 mm	x = 1 mm
180 mm – 7"	01-2789-01	01-2789-02	01-2789-03	01-2789-04

without ratchet straight, smooth curved, smooth straight, serrated curved, serrated

	T.C	T.C	T.C	T.C
	x = 1 mm	x = 1 mm	x = 1 mm	x = 1 mm
180 mm – 7"	01-2789-05	01-2789-06	01-2789-07	01-2789-08

with ratchet straight, smooth curved, smooth straight, serrated curved, serrated

Micro needle holders



YASARGIL

			diamond Coated	diamond Coated
180 mm – 7"	01-2790-01	01-2790-02	01-2790-01D	01-2790-02D
200 mm – 8"	01-2791-01	01-2791-02	01-2791-01D	01-2791-02D

without ratchet

straight

curved

straight

curved

			diamond Coated	diamond Coated
180 mm – 7"	01-2792-01	01-2792-02	01-2792-01D	01-2792-02D
200 mm – 8"	01-2793-01	01-2793-02	01-2793-01D	01-2793-02D

with ratchet

straight

curved

straight

curved

Micro needle holders with round handle



1:1

YASARGIL



			diamond Coated	diamond Coated
	x = 1 mm	x = 1 mm	x = 1 mm	x = 1 mm
210 mm – 8 ¼ "	01-2794-01	01-2794-02	01-2794-01D	01-2794-02D

without ratchet

straight

curved

straight

curved

			diamond Coated	diamond Coated
	x = 1 mm	x = 1 mm	x = 1 mm	x = 1 mm
210 mm – 8 ¼ "	01-2795-01	01-2795-02	01-2795-01D	01-2795-02D

with ratchet

straight

curved

straight

curved



	T.C	T.C	T.C	T.C
	x = 1 mm	x = 1 mm	x = 1 mm	x = 1 mm
210 mm – 8 ¼ "	01-2794-01TCG	01-2794-02TCG	01-2794-01TCS	01-2794-02TCS

without ratchet

straight, smooth

curved, smooth

straight, serrated

curved, serrated

	T.C	T.C	T.C	T.C
	x = 1 mm	x = 1 mm	x = 1 mm	x = 1 mm
210 mm – 8 ¼ "	01-2795-01TCG	01-2795-02TCG	01-2795-01TCS	01-2795-02TCS

with ratchet

straight, smooth

curved, smooth

straight, serrated

curved, serrated

Micro needle holders with round handle



110 mm – 4 ¼ "	01-2796-01	01-2797-01
125 mm – 5 "	01-2796-02	01-2797-02
130 mm – 5 "	01-2796-03	01-2797-03
150 mm – 6 "	01-2796-04	01-2797-04
180 mm – 7 "	01-2796-05	01-2797-05

without ratchet straight curved

110 mm – 4 ¼ "	01-2798-01	01-2799-01
125 mm – 5 "	01-2798-02	01-2799-02
130 mm – 5 "	01-2798-03	01-2799-03
150 mm – 6 "	01-2798-04	01-2799-04
180 mm – 7 "	01-2798-05	01-2799-05

with ratchet straight curved

Micro needle holders with round handle



barraquer



				diamond Coated	diamond Coated
140 mm – 5 ½ "	8 mm Ø	01-2800	01-2801	01-2800D	01-2802D

without ratchet, extra delicate jaws

straight

curved

straight

curved

				diamond Coated	diamond Coated
140 mm – 5 ½ "	8 mm Ø	01-2802	01-2803	01-2802D	01-2803D

with ratchet, extra delicate jaws

straight

curved

straight

curved

Micro needle holders



150 mm - 6"	9 mm \varnothing	01-2804
-------------	--------------------	---------

without ratchet, curved

Micro-needle holders, 90° twisted

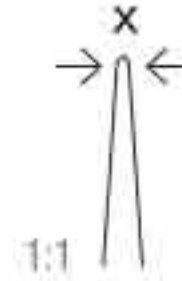
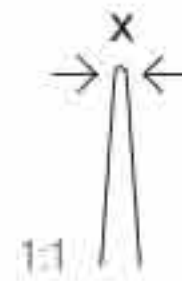

	x = 0.4 mm	x = 0.4 mm	x = 0.9 mm	x = 0.9 mm
200 mm – 8"	01-2805-01	01-2806-01	01-2807-01	01-2808-01
225 mm – 8 ¾"	01-2805-02	01-2806-02	01-2807-02	01-2808-02
240 mm – 9 ½"	01-2805-03	01-2806-03	01-2807-03	01-2808-03

without ratchet

straight

curved

straight

curved

	diamond Coated	diamond Coated	diamond Coated	diamond Coated
	x = 0.4 mm	x = 0.4 mm	x = 0.9 mm	x = 0.9 mm
200 mm – 8"	01-2805-01D	01-2806-01D	01-2807-01D	01-2808-01D
225 mm – 8 ¾"	01-2805-02D	01-2806-02D	01-2807-02D	01-2808-02D
240 mm – 9 ½"	01-2805-03D	01-2806-03D	01-2807-03D	01-2808-03D

without ratchet, diamond coated straight

curved

straight

curved

Micro needle holders



JACOBSON



			diamond Coated	diamond Coated
180 mm – 7"	01-2809	01-2810	01-2809D	01-2810D

without ratchet straight curved straight curved

			diamond Coated	diamond Coated
180 mm – 7"	01-2811	01-2812	01-2811D	01-2812D

with ratchet straight curved straight curved

Micro needle holders



1:1

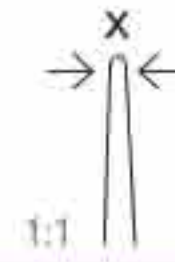
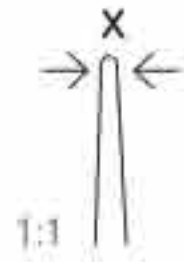

			diamond Coated	diamond Coated
9 mm Ø	x = 1.0 mm	x = 1.0 mm	x = 1.0 mm	x = 1.0 mm
230 mm – 9"	01-2813-01	01-2813-02	01-2813-03D	01-2813-04D

without ratchet straight curved straight curved

			diamond Coated	diamond Coated
9 mm Ø	x = 1.0 mm	x = 1.0 mm	x = 1.0 mm	x = 1.0 mm
230 mm – 9"	01-2814-01	01-2814-02	01-2814-03D	01-2814-04D

with ratchet straight curved straight curved



	T.C	T.C	T.C	T.C
9 mm Ø				
230 mm – 9"	01-2815-01	01-2815-02	01-2815-03	01-2815-04

without ratchet straight, smooth curved, smooth straight, serrated curved, serrated

	T.C	T.C	T.C	T.C
9 mm Ø				
230 mm – 9"	01-2816-01	01-2816-02	01-2816-03	01-2816-04

with ratchet straight, smooth curved, smooth straight, serrated curved, serrated

Micro needle holders



	titan	titan
	0.3 mm x 0.4 mm	0.3 mm x 0.4 mm
180 mm – 7"	01-2819	01-2820

with ratchet



	titan	titan
	0.8 mm x 0.8 mm	0.8 mm x 0.8 mm
185 mm – 7 ¼"	01-2817	01-2818

with ratchet

1:1

Micro needle holders



	titan	titan
	0.5 mm x 0.8 mm	0.5 mm x 0.8 mm
200 mm – 8"	01-2825	01-2826

with ratchet



	titan	titan	titan	titan
	0.4 x 0.6 mm	0.4 x 0.6 mm	0.6 x 0.6 mm	0.6 x 0.6 mm
200 mm – 8"	01-2821	01-2822	01-2823	01-2824

with ratchet

Micro needle holders



225 mm – 8 ¾ "	01-2827-01	01-2828-01
----------------	------------	------------

	T.C	T.C
225 mm – 8 ¾ "	01-2827-02	01-2828-02

	titan	titan
225 mm – 8 ¾ "	01-2827-03	01-2828-03

without ratchet

	titan	titan
225 mm – 8 ¾ "	01-2829-01	01-2830-01
225 mm – 8 ¾ "	01-2829-02	01-2830-02

with ratchet

Laminectomy punches



1:1	1:1	1:1	1:1	1:1	1:1
1 mm	2 mm	3 mm	4 mm	5 mm	6 mm

FERRIS-SMITH-KERRISON



	x = 150mm – 6"	x = 180 mm – 7 "	x = 200 mm – 8"	x = 230 mm – 9"
1 mm	01-2831-01	01-2832-01	01-2833-01	01-2834-01
2 mm	01-2831-02	01-2832-02	01-2833-02	01-2834-02
3 mm	01-2831-03	01-2832-03	01-2833-03	01-2834-03
4 mm	01-2831-04	01-2832-04	01-2833-04	01-2834-04
5 mm	01-2831-05	01-2832-05	01-2833-05	01-2834-05
6 mm	01-2831-06	01-2832-06	01-2833-06	01-2834-06

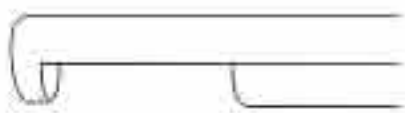

1 mm	01-2835-01	01-2836-01	01-2837-01	01-2838-01
2 mm	01-2835-02	01-2836-02	01-2837-02	01-2838-02
3 mm	01-2835-03	01-2836-03	01-2837-03	01-2838-03
4 mm	01-2835-04	01-2836-04	01-2837-04	01-2838-04
5 mm	01-2835-05	01-2836-05	01-2837-05	01-2838-05
6 mm	01-2835-06	01-2836-06	01-2837-06	01-2838-06

Dismantable laminectomy punches

easy dismantling and assembling



dismantable for easy cleaning and better hygiene

Dismantling

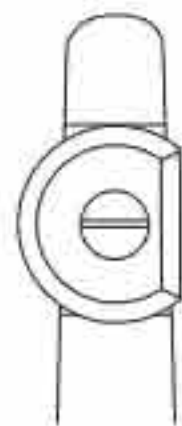

closed position



turn to open

opening of the locking nut by a quarter turn.



Pulling backwards of the upper cutting part.

Dismantable laminectomy punches

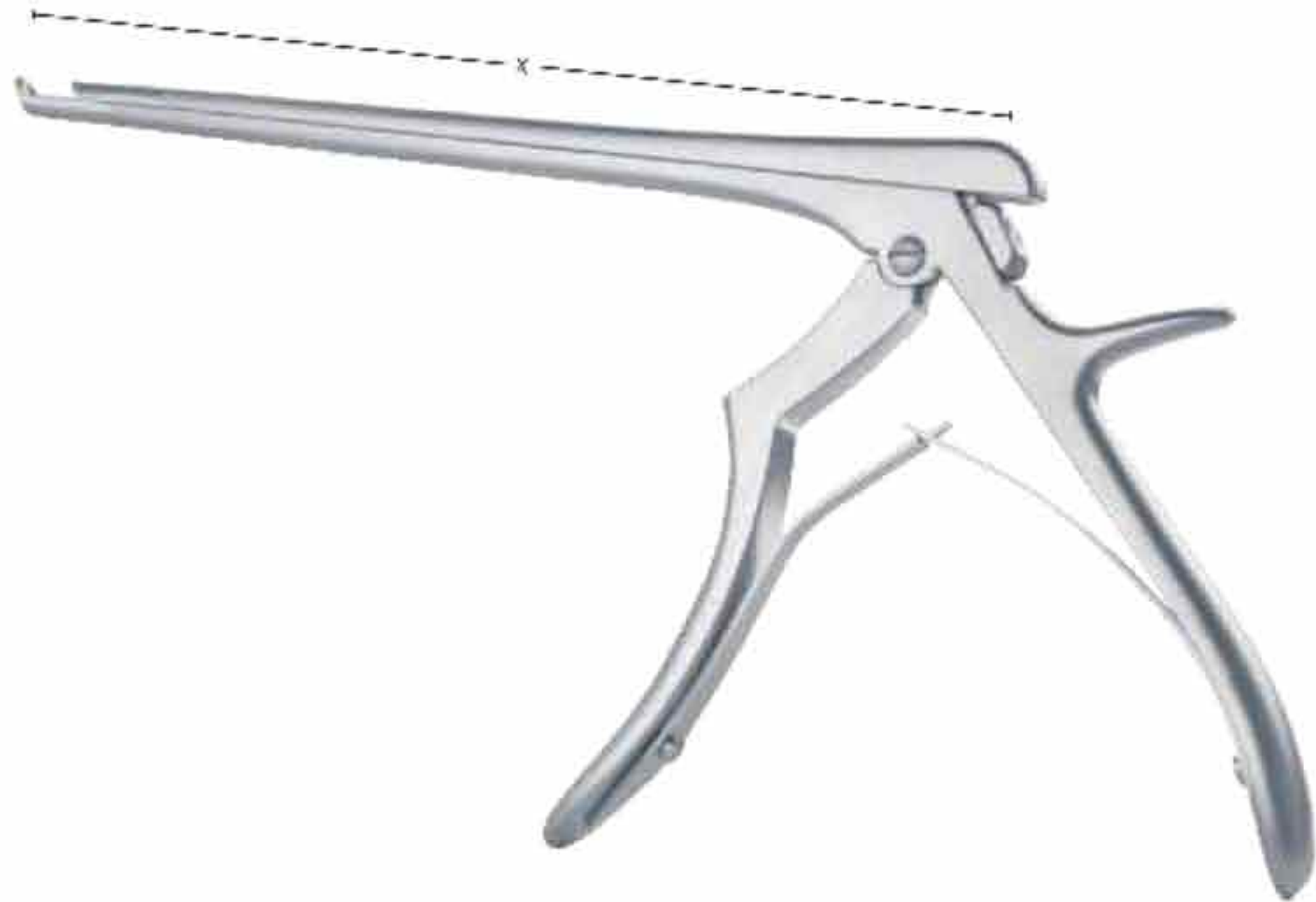

1:1 	1:1 	1:1 	1:1 	1:1 	1:1 
1 mm	2 mm	3 mm	4 mm	5 mm	6 mm

FERRIS-SMITH-KERRISON



	x = 180 mm - 7"	x = 200 mm - 8"	x = 230 mm - 9"
1 mm	01-2832-01Z	01-2833-01Z	01-2834-01Z
2 mm	01-2832-02Z	01-2833-02Z	01-2834-02Z
3 mm	01-2832-03Z	01-2833-03Z	01-2834-03Z
4 mm	01-2832-04Z	01-2833-04Z	01-2834-04Z
5 mm	01-2832-05Z	01-2833-05Z	01-2834-05Z
6 mm	01-2832-06Z	01-2833-06Z	01-2834-06Z



1 mm	01-2836-01Z	01-2837-01Z	01-2838-01Z
2 mm	01-2836-02Z	01-2837-02Z	01-2838-02Z
3 mm	01-2836-03Z	01-2837-03Z	01-2838-03Z
4 mm	01-2836-04Z	01-2837-04Z	01-2838-04Z
5 mm	01-2836-05Z	01-2837-05Z	01-2838-05Z
6 mm	01-2836-06Z	01-2837-06Z	01-2838-06Z

Laminectomy punches

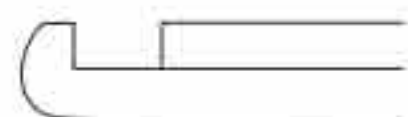

COLCLOUGH

	x = 150 mm – 6"	x = 200 mm – 8"
3 mm	01-2839-01	01-2839-02
5 mm	01-2840-01	01-2840-02

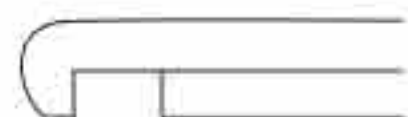

3 mm	01-2841-01	01-2841-02
5 mm	01-2842-01	01-2842-02

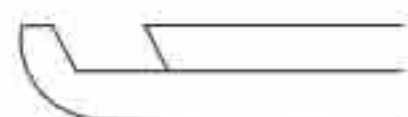

3 mm	01-2843-01	01-2843-02
5 mm	01-2844-01	01-2844-02

Laminectomy punches



1:2

1:1 

5 mm

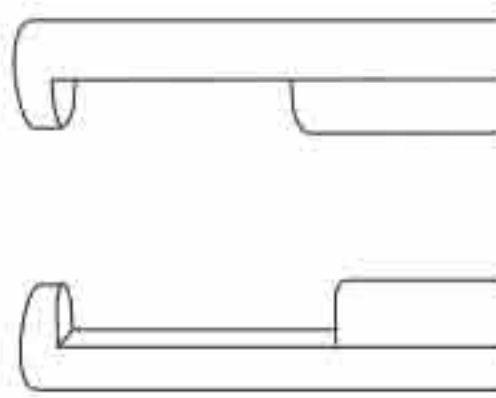

FERRIS-SMITH-KERRISON

	x = 180 mm – 7"
5 mm	01-2845

5 mm	01-2846
-------------	---------

Laminectomy punches

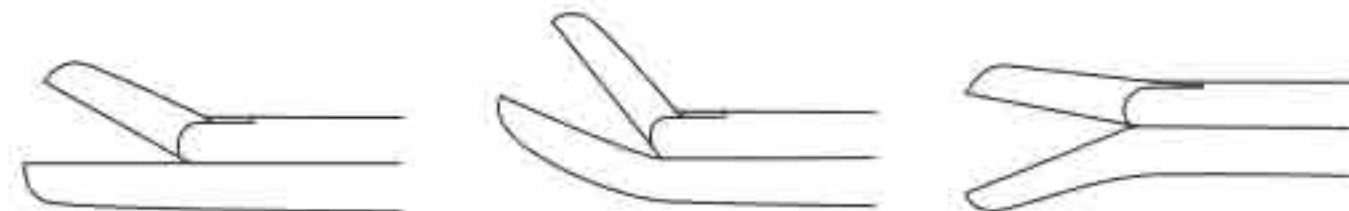

1:1 

CUSHING

	2 mm x 10 mm	2 mm x 10 mm	2 mm x 10 mm
x = 130 mm – 5"	01-2847-01	01-2848-01	01-2849-01
x = 180 mm – 7"	01-2847-02	01-2848-02	01-2849-02
x = 220 mm – 8¾"	01-2847-03	01-2848-03	01-2849-03

1:1 

LOVE-GRUENWALD

	3 mm x 10 mm	3 mm x 10 mm	3 mm x 10 mm
x = 130 mm – 5"	01-2850-01	01-2851-01	01-2852-01
x = 150 mm – 6"	01-2850-02	01-2851-02	01-2852-02
x = 180 mm – 7"	01-2850-03	01-2851-03	01-2852-03

1:1 

SPURLING

	4 mm x 10 mm	4 mm x 10 mm	4 mm x 10 mm
x = 150 mm – 6"	01-2853-01	01-2854-01	01-2855-01
x = 180 mm – 7"	01-2853-02	01-2854-02	01-2855-02
x = 230 mm – 9"	01-2853-03	01-2854-03	01-2855-03

1:1 



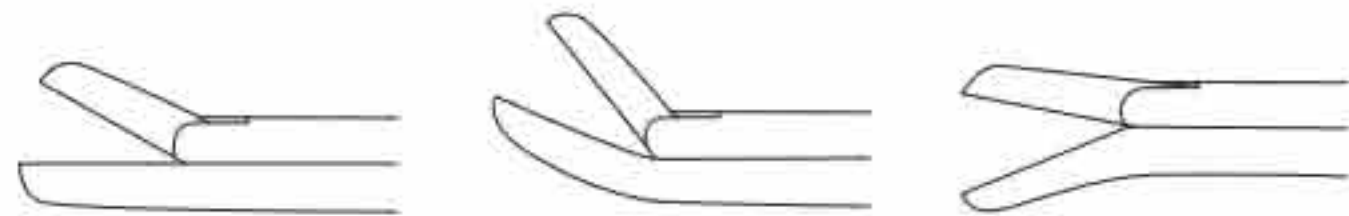

CLOWARD

	6 mm x 10 mm
x = 180 mm – 7"	01-2856

Laminectomy punches

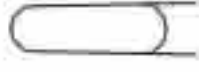

FERRIS-SMITH

	x = 180 mm – 7"	x = 180 mm – 7"	x = 180 mm – 7"
1:1 	2 mm x 10 mm	01-2857-01	01-2858-01
1:1 	3 mm x 10 mm	01-2857-02	01-2858-02
1:1 	4 mm x 10 mm	01-2857-03	01-2858-03
1:1 	5 mm x 10 mm	01-2857-04	01-2858-04
1:1 	6 mm x 10 mm	01-2857-05	01-2858-05

Laminectomy punches

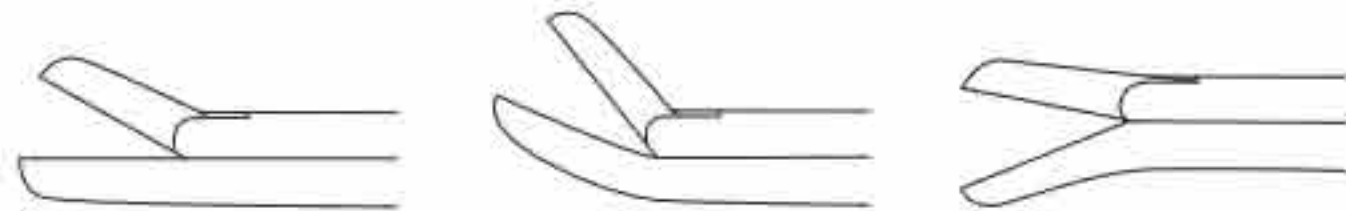

CASPAR

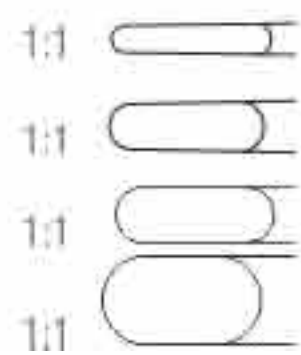

	x = 155 mm – 6"	x = 155 mm – 6"	x = 155 mm – 6"
2 mm	01-2860-01	01-2861-01	01-2862-01
3 mm	01-2860-02	01-2861-02	01-2862-02
4 mm	01-2860-03	01-2861-03	01-2862-03
5 mm	01-2860-04		

Laminectomy punches



OLDBERG

$x = 180 \text{ mm} - 7''$	3.5 mm \varnothing	6.0 mm \varnothing
	01-2863-01	01-2863-02



SCHLESINGER

	2 mm x 10 mm	3 mm x 10 mm	4 mm x 10 mm
	$x = 125 \text{ mm} - 5''$	$x = 125 \text{ mm} - 5''$	$x = 125 \text{ mm} - 5''$
190 mm - 7 1/2''	01-2864-01	01-2864-02	01-2864-03

saw edge

Laminectomy punches



CASPAR

	x = 140 mm – 5½"	x = 160 mm – 6¼"	x = 185 mm – 7¼"
2 mm x 12 mm	01-2865-01	01-2866-01	01-2867-01
3 mm x 12 mm	01-2865-02	01-2866-02	01-2867-02
4 mm x 14 mm	01-2865-03	01-2866-03	01-2867-03
5 mm x 14 mm	01-2865-04	01-2866-04	01-2867-04
6 mm x 16 mm	01-2865-05	01-2866-05	01-2867-05



	x = 140 mm – 5½"	x = 160 mm – 6¼"	x = 185 mm – 7¼"
2 mm x 12 mm	01-2868-01	01-2869-01	
2.5 mm x 12 mm	01-2868-02	01-2869-02	01-2870-01
4 mm x 14 mm	01-2868-03	01-2869-03	01-2870-02
5 mm x 14 mm	01-2868-04	01-2869-04	01-2870-03



	x = 140 mm – 5½"	x = 160 mm – 6¼"	x = 185 mm – 7¼"
2 mm x 12 mm	01-2871-01	01-2872-01	
3 mm x 12 mm	01-2871-02	01-2872-02	01-2873-01
4 mm x 14 mm	01-2871-03	01-2872-03	01-2873-02

Laminectomy punches



**WEIL-
BLAKESLEY**

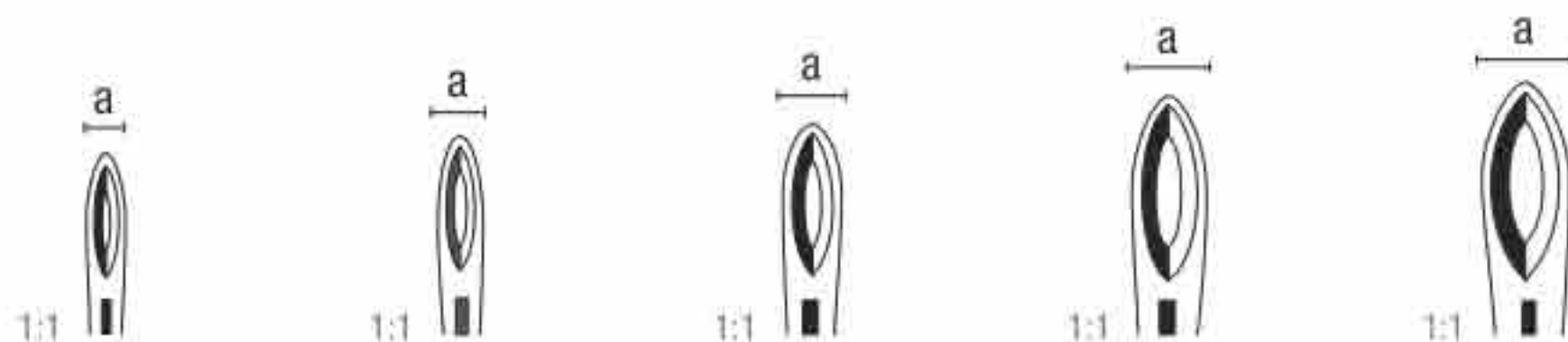

	Fig. 1	Fig. 2	Fig. 3	Fig. 4	Fig. 5
	a = 3.0 mm	a = 3.5 mm	a = 4.5 mm	a = 5.0 mm	a = 5.5 mm



x = 120 mm – 4 3/4 "	01-2874-01	01-2874-02	01-2874-03	01-2874-04	01-2874-05
-----------------------------	------------	------------	------------	------------	------------



x = 120 mm – 4 3/4 "	01-2875-01	01-2875-02	01-2875-03	01-2875-04	
-----------------------------	------------	------------	------------	------------	--



x = 120 mm – 4 3/4 "	01-2876-01	01-2876-02	01-2876-03		
-----------------------------	------------	------------	------------	--	--

	Fig. 1	Fig. 2	Fig. 3	Fig. 4	Fig. 5
	a = 3.0 mm	a = 3.5 mm	a = 4.5 mm	a = 5.0 mm	a = 5.5 mm



x = 180 mm – 7 "	01-2877-01	01-2877-02	01-2877-03	01-2877-04	01-2877-05
-------------------------	------------	------------	------------	------------	------------



x = 180 mm – 7 "	01-2878-01	01-2878-02	01-2878-03	01-2878-04	
-------------------------	------------	------------	------------	------------	--



USA

1233 Capitol Drive, Suite D
Addison IL 60101 USA
+1 773-997-3421
info@tritoneinc.net

South America

Rua Tocatis 26, sala 10-Jardiam Guanabara
13.211-818-Jundiai-SP-Brasil
info@tritoneinc.net

Overseas HQ

Stone Instruments Co.
10 Daska Rd, Sialkot
Pakistan 51310
+92 300 8610825

ISO 13485:2016 Certified
FDA Registered
9614093
3012256357
D-U-N-S # : 112392098